

Part Number: AM2520EG/4SGD5V

Super Bright Green

Features

- BLACK CASE ENHANCES CONTRAST.
- VIBRATION AND SHOCK RESISTANT.
- AVAILABLE WITH A VARIETY OF LEDs.
- UL RATING : 94V-0.
- HOUSING MATERIAL: TYPE 66 NYLON.
- 5V INTERNAL RESISTOR.
- RoHS COMPLIANT.

Description

The Super Bright Green source color devices are made with Gallium Phosphide Green Light Emitting Diode.

Package Dimensions

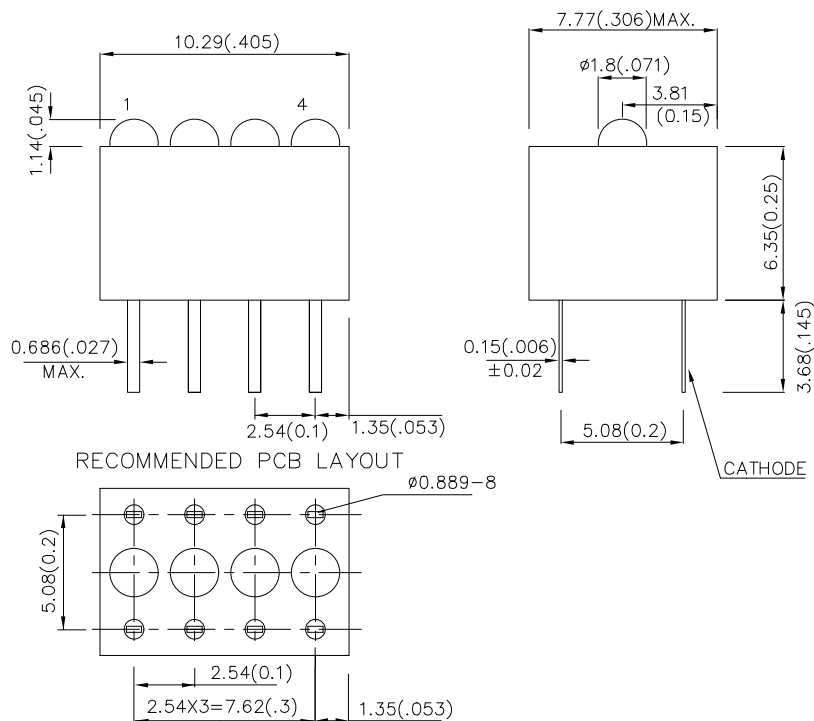

Notes:

1. All dimensions are in millimeters (inches).
2. Tolerance is $\pm 0.25(0.01)$ " unless otherwise noted.
3. Lead spacing is measured where the leads emerge from the package.
4. Specifications are subject to change without notice.



Selection Guide

Part No.	Dice	Lens Type	Iv (mcd) [2] V= 5V		Viewing Angle [1]
			Min.	Typ.	2θ1/2
AM2520EG/4SGD5V	Super Bright Green (GaP)	GREEN DIFFUSED	1.8	8	40°

Notes:

1. θ1/2 is the angle from optical centerline where the luminous intensity is 1/2 the optical centerline value.
2. Luminous intensity/ luminous Flux: +/-15%.

Electrical / Optical Characteristics at TA=25°C

Symbol	Parameter	Device	Typ.	Max.	Units	Test Conditions
λ _{peak}	Peak Wavelength	Super Bright Green	565		nm	V _F =5V
λ _D [1]	Dominant Wavelength	Super Bright Green	568		nm	V _F =5V
Δλ _{1/2}	Spectral Line Half-width	Super Bright Green	30		nm	V _F =5V
I _F	Forward Current	Super Bright Green	11.5	17.5	mA	V _F =5V
I _R	Reverse Current	Super Bright Green		10	μA	V _R = 5V

Note:

- 1.Wavelength: +/-1nm.

Absolute Maximum Ratings at TA=25°C

Parameter	Super Bright Green	Units
Power dissipation	85	mW
Forward Voltage	6	V
Reverse Voltage	5	V
Operating Temperature	-40°C To +70°C	
Storage Temperature	-40°C To +85°C	
Lead Solder Temperature [1]	260°C For 3 Seconds	
Lead Solder Temperature [2]	260°C For 5 Seconds	

Notes:

1. 2mm below package base.
2. 5mm below package base.



Super Bright Green AM2520EG/4SGD5V

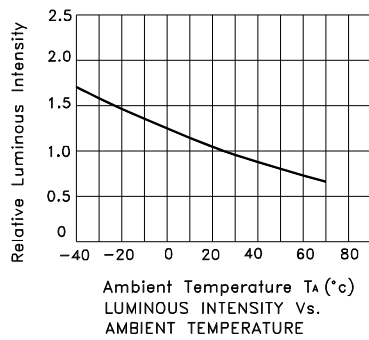
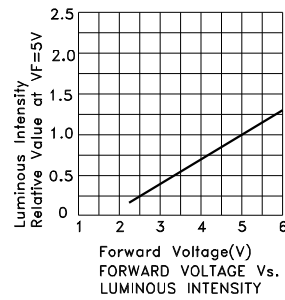
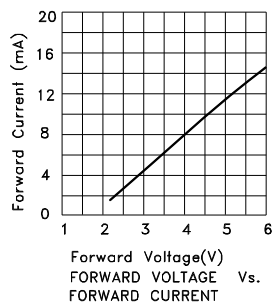

PACKING & LABEL SPECIFICATIONS

AM2520EG/4SGD5V

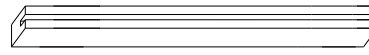
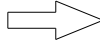
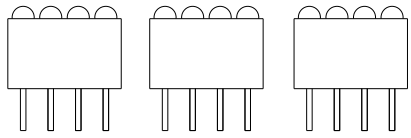

48PCS / IC TUBE

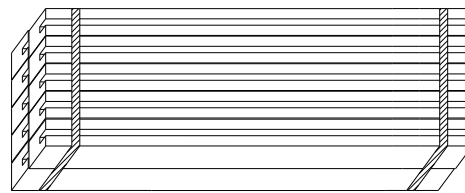

480pcs / 10pcs IC TUBE



OUTSIDE LABEL

10.56K / 10# BOX

<h1>Kingbright</h1>	
Q.C.	QC XX XX XX PASSED
TYPE NO : AM2520EGxxx	
QUANTITY : 480 pcs	
S/N : XX	CODE: XX
LOT NO : 	
RoHS Compliant	