

POWER MOS 7® MOSFET

Power MOS 7® is a new generation of low loss, high voltage, N-Channel enhancement mode power MOSFETS. Both conduction and switching losses are addressed with Power MOS 7® by significantly lowering $R_{DS(ON)}$ and Q_g . Power MOS 7® combines lower conduction and switching losses along with exceptionally fast switching speeds inherent with APT's patented metal gate structure.

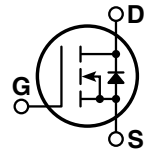

- Lower Input Capacitance
- Lower Miller Capacitance
- Lower Gate Charge, Q_g
- Increased Power Dissipation
- Easier To Drive
- Popular SOT-227 Package

MAXIMUM RATINGS

 All Ratings: $T_C = 25^\circ\text{C}$ unless otherwise specified.

Symbol	Parameter	APT8020JLL	UNIT
V_{DSS}	Drain-Source Voltage	800	Volts
I_D	Continuous Drain Current @ $T_C = 25^\circ\text{C}$	33	Amps
I_{DM}	Pulsed Drain Current ^①	132	Amps
V_{GS}	Gate-Source Voltage Continuous	±30	Volts
V_{GSM}	Gate-Source Voltage Transient	±40	
P_D	Total Power Dissipation @ $T_C = 25^\circ\text{C}$	520	Watts
	Linear Derating Factor	4.16	W/°C
T_J, T_{STG}	Operating and Storage Junction Temperature Range	-55 to 150	°C
T_L	Lead Temperature: 0.063" from Case for 10 Sec.	300	
I_{AR}	Avalanche Current ^① (Repetitive and Non-Repetitive)	33	Amps
E_{AR}	Repetitive Avalanche Energy ^①	50	mJ
E_{AS}	Single Pulse Avalanche Energy ^④	3000	

STATIC ELECTRICAL CHARACTERISTICS

Symbol	Characteristic / Test Conditions	MIN	TYP	MAX	UNIT
BV_{DSS}	Drain-Source Breakdown Voltage ($V_{GS} = 0V, I_D = 250\mu\text{A}$)	800			Volts
$R_{DS(on)}$	Drain-Source On-State Resistance ^② ($V_{GS} = 10V, I_D = 16.5A$)			0.200	Ohms
I_{DSS}	Zero Gate Voltage Drain Current ($V_{DS} = 200V, V_{GS} = 0V$)			100	μA
	Zero Gate Voltage Drain Current ($V_{DS} = 160V, V_{GS} = 0V, T_C = 125^\circ\text{C}$)			500	
I_{GSS}	Gate-Source Leakage Current ($V_{GS} = \pm 30V, V_{DS} = 0V$)			±100	nA
$V_{GS(th)}$	Gate Threshold Voltage ($V_{DS} = V_{GS}, I_D = 2.5mA$)	3		5	Volts

 **CAUTION:** These Devices are Sensitive to Electrostatic Discharge. Proper Handling Procedures Should Be Followed.

DYNAMIC CHARACTERISTICS

APT8020JLL

Symbol	Characteristic	Test Conditions	MIN	TYP	MAX	UNIT
C _{iss}	Input Capacitance	V _{GS} = 0V V _{DS} = 25V f = 1 MHz		5200		pF
C _{oss}	Output Capacitance			1000		
C _{rss}	Reverse Transfer Capacitance			190		
Q _g	Total Gate Charge ③	V _{GS} = 10V V _{DD} = 400V I _D = 33A @ 25°C		195		nC
Q _{gs}	Gate-Source Charge			27		
Q _{gd}	Gate-Drain ("Miller") Charge			130		
t _{d(on)}	Turn-on Delay Time	RESISTIVE SWITCHING V _{GS} = 15V V _{DD} = 400V I _D = 33A @ 25°C R _G = 0.6Ω		12		ns
t _r	Rise Time			14		
t _{d(off)}	Turn-off Delay Time			39		
t _f	Fall Time			10		
E _{on}	Turn-on Switching Energy ⑥	INDUCTIVE SWITCHING @ 25°C V _{DD} = 533V, V _{GS} = 15V I _D = 33A, R _G = 5Ω		760		μJ
E _{off}	Turn-off Switching Energy			715		
E _{on}	Turn-on Switching Energy ⑥	INDUCTIVE SWITCHING @ 125°C V _{DD} = 533V, V _{GS} = 15V I _D = 33A, R _G = 5Ω		1250		
E _{off}	Turn-off Switching Energy			780		

SOURCE-DRAIN DIODE RATINGS AND CHARACTERISTICS

Symbol	Characteristic / Test Conditions	MIN	TYP	MAX	UNIT
I _S	Continuous Source Current (Body Diode)			33	Amps
I _{SM}	Pulsed Source Current ① (Body Diode)			142	
V _{SD}	Diode Forward Voltage ② (V _{GS} = 0V, I _S = -33A)			1.3	Volts
t _{rr}	Reverse Recovery Time (I _S = -33A, di _S /dt = 100A/μs)		920		ns
Q _{rr}	Reverse Recovery Charge (I _S = -33A, di _S /dt = 100A/μs)		20.7		μC
dv/dt	Peak Diode Recovery dv/dt ⑤			10	V/ns

THERMAL CHARACTERISTICS

Symbol	Characteristic	MIN	TYP	MAX	UNIT
R _{θJC}	Junction to Case			0.24	°C/W
R _{θJA}	Junction to Ambient			40	

- ① Repetitive Rating: Pulse width limited by maximum junction temperature
- ② Pulse Test: Pulse width < 380 μs, Duty Cycle < 2%
- ③ See MIL-STD-750 Method 3471
- ④ Starting T_j = +25°C, L = 5.51mH, R_G = 25Ω, Peak I_L = 33A
- ⑤ dv/dt numbers reflect the limitations of the test circuit rather than the device itself. I_S ≤ -I_D33A di/dt ≤ 700A/μs v_R ≤ 800V T_J ≤ 150°C
- ⑥ Eon includes diode reverse recovery. See figures 18, 20.

APT Reserves the right to change, without notice, the specifications and information contained herein.

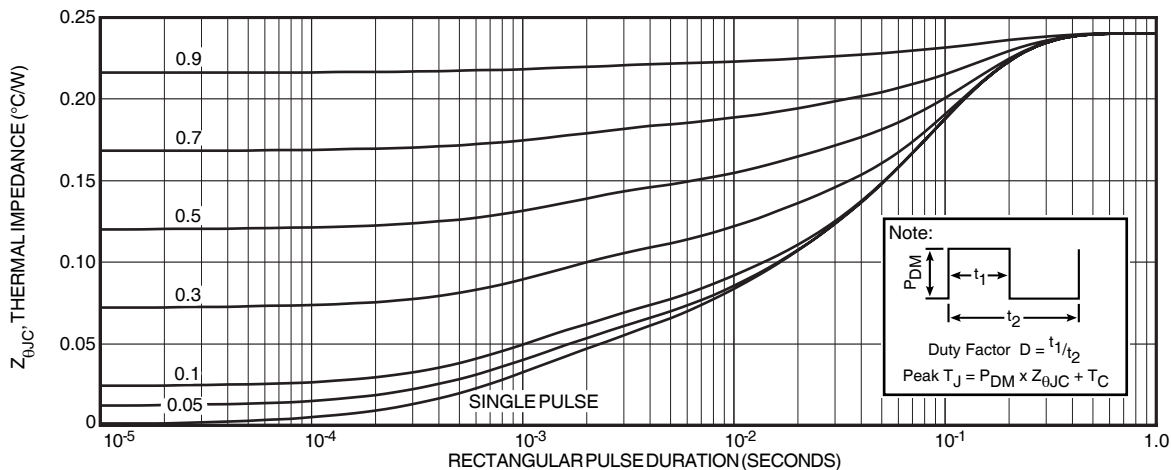

FIGURE 1, MAXIMUM EFFECTIVE TRANSIENT THERMAL IMPEDANCE, JUNCTION-TO-CASE vs PULSE DURATION

Typical Performance Curves

APT8020JLL

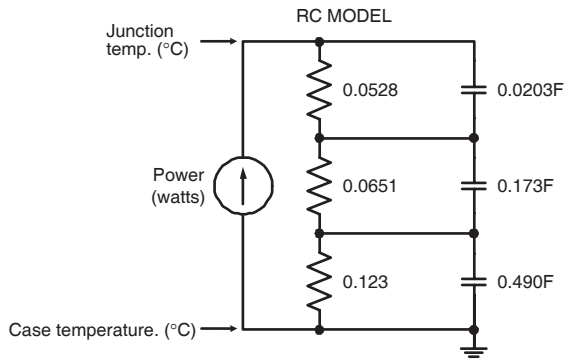

FIGURE 2, TRANSIENT THERMAL IMPEDANCE MODEL

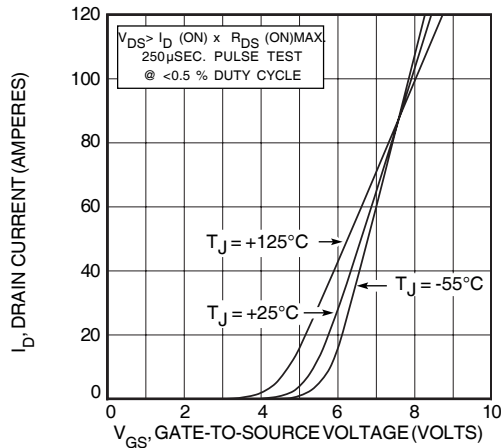

FIGURE 4, TRANSFER CHARACTERISTICS

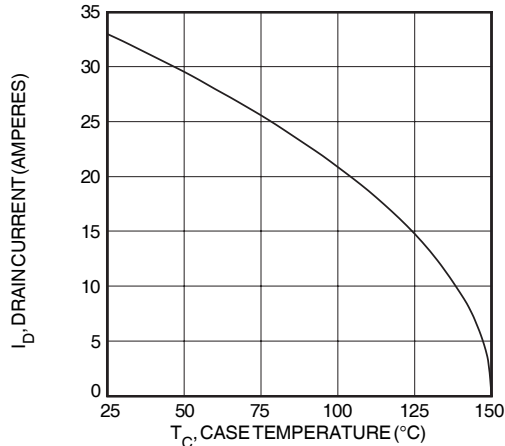

FIGURE 6, MAXIMUM DRAIN CURRENT vs CASE TEMPERATURE

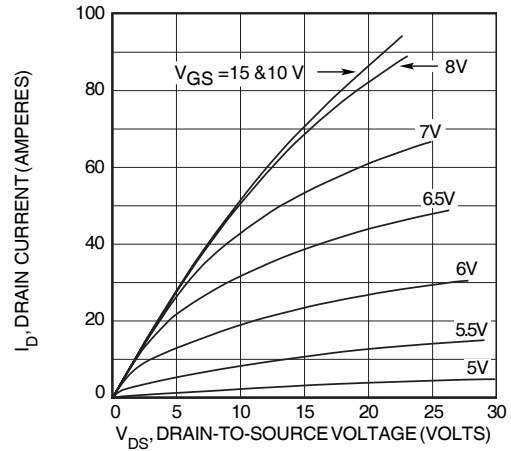
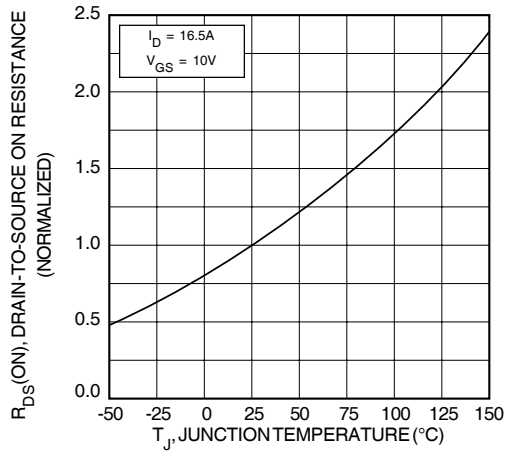

FIGURE 3, LOW VOLTAGE OUTPUT CHARACTERISTICS

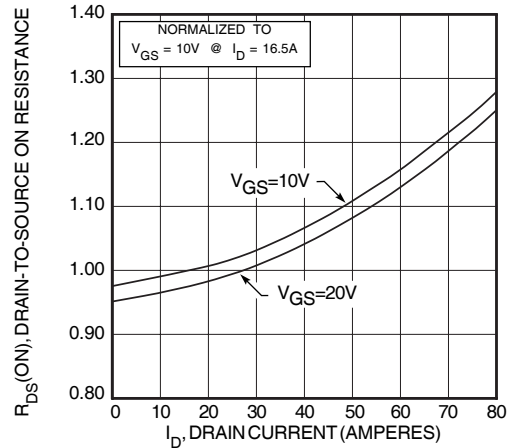

FIGURE 5, $R_{DS}(ON)$ vs DRAIN CURRENT

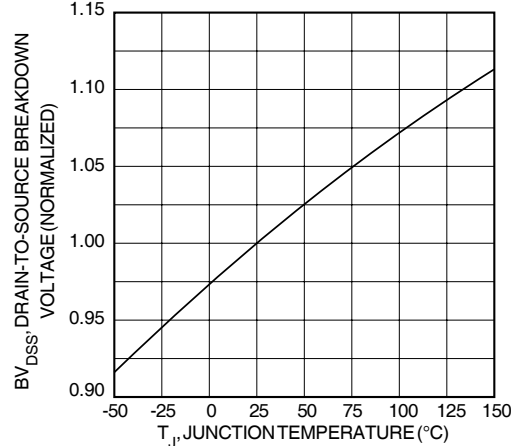
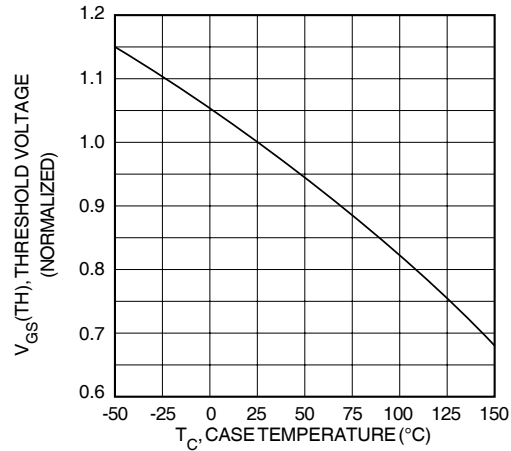

FIGURE 7, BREAKDOWN VOLTAGE vs TEMPERATURE



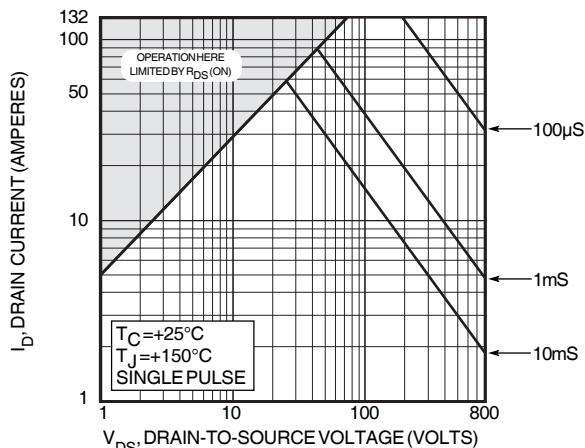

FIGURE 10, MAXIMUM SAFE OPERATING AREA

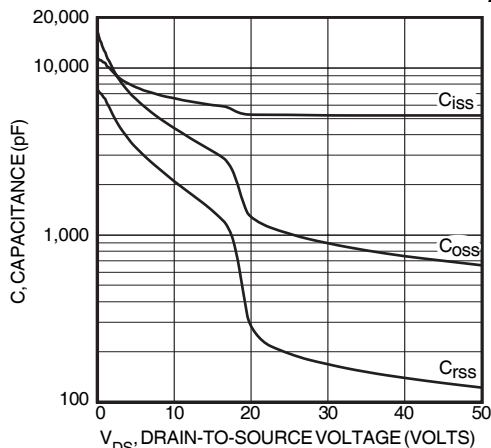

FIGURE 11, CAPACITANCE vs DRAIN-TO-SOURCE VOLTAGE

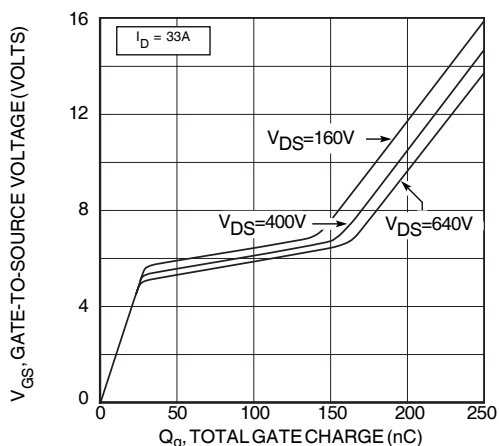

FIGURE 12, GATE CHARGES vs GATE-TO-SOURCE VOLTAGE

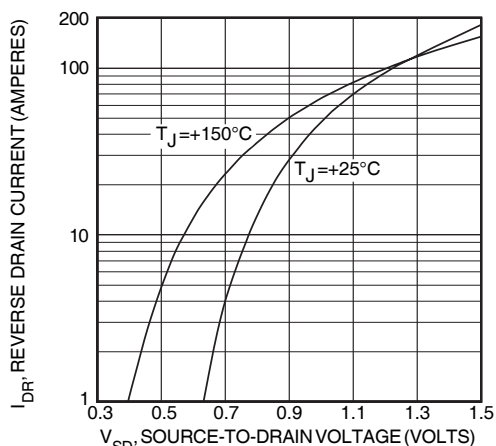

FIGURE 13, SOURCE-DRAIN DIODE FORWARD VOLTAGE

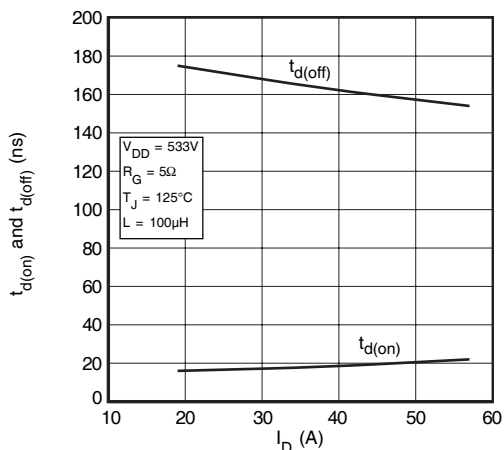

FIGURE 14, DELAY TIMES vs CURRENT

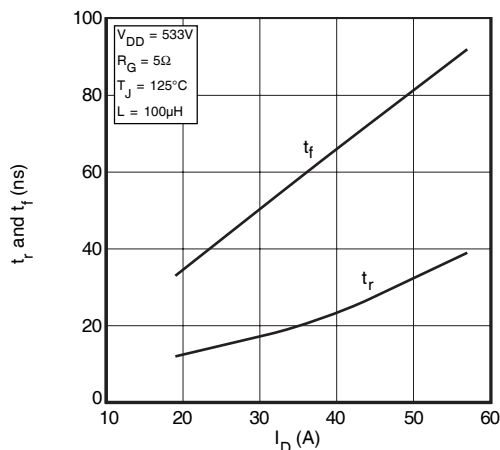

FIGURE 15, RISE AND FALL TIMES vs CURRENT

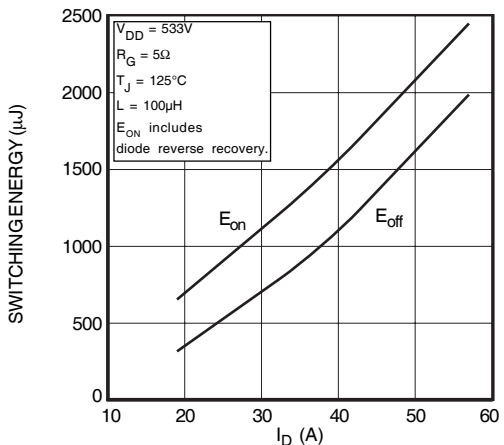

FIGURE 16, SWITCHING ENERGY vs CURRENT

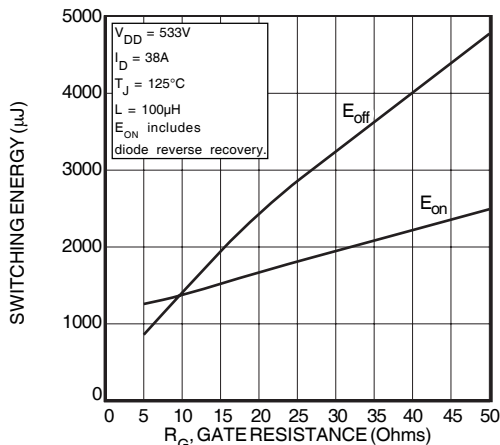

FIGURE 17, SWITCHING ENERGY vs. GATE RESISTANCE

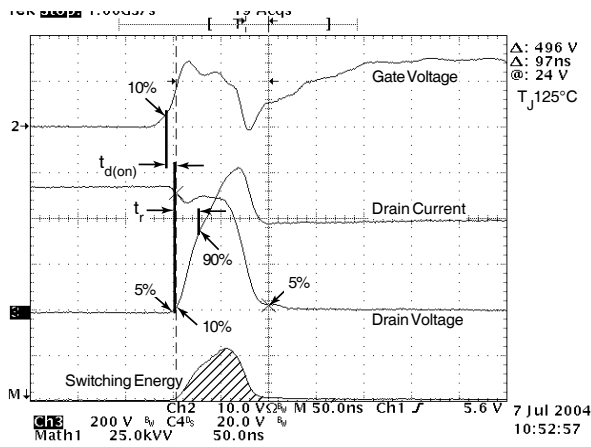

Figure 18, Turn-on Switching Waveforms and Definitions

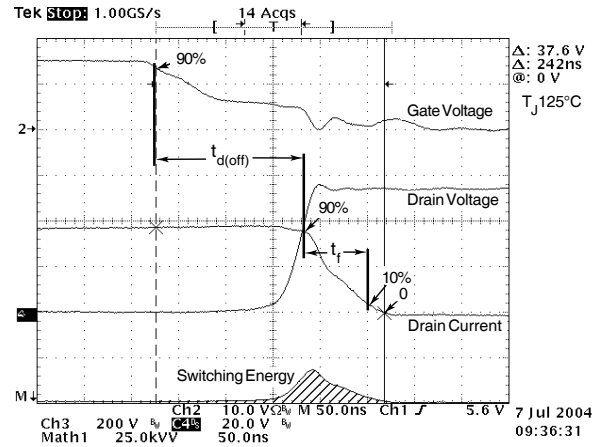

Figure 19, Turn-off Switching Waveforms and Definitions

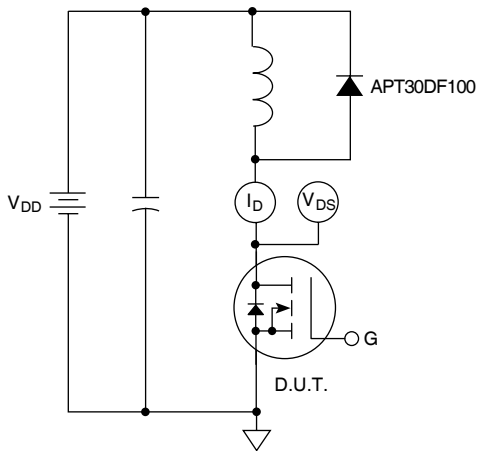
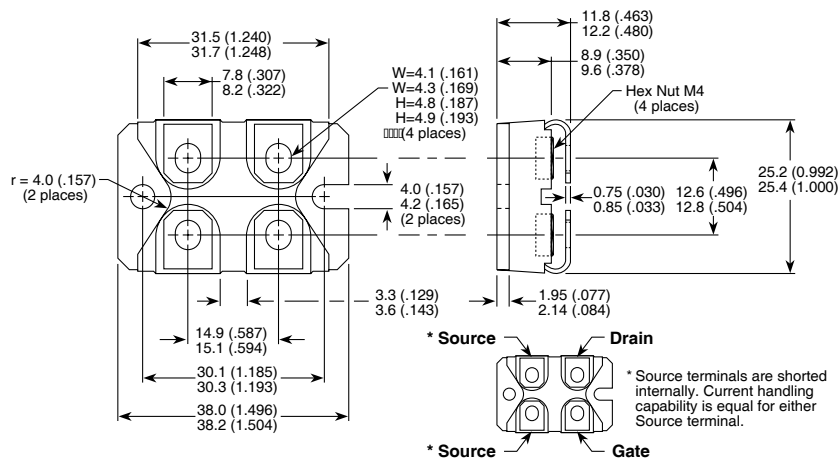

Figure 20, Inductive Switching Test Circuit

SOT-227 (ISOTOP®) Package Outline



Dimensions in Millimeters and (Inches)

ISOTOP® is a Registered Trademark of SGS Thomson. APT's products are covered by one or more of U.S. patents 4,895,810 5,045,903 5,089,434 5,182,234 5,019,522 5,262,336 6,503,786 5,256,583 4,748,103 5,283,202 5,231,474 5,434,095 5,528,058 and foreign patents. US and Foreign patents pending. All Rights Reserved.