

PRELIMINARY SPEC

Part Number: APTB1612SYKCGKC-F01

Super Bright Yellow
Green

Features

- 1.6mmx1.25mm SMT LED, 0.65mm THICKNESS.
- BI-COLOR, LOW POWER CONSUMPTION.
- WIDE VIEWING ANGLE.
- IDEAL FOR BACKLIGHT AND INDICATOR.
- VARIOUS COLORS AND LENS TYPES AVAILABLE.
- PACKAGE : 2000PCS / REEL.
- MOISTURE SENSITIVITY LEVEL : LEVEL 3.
- RoHS COMPLIANT.

Description

The Super Bright Yellow device is made with DH InGaAlP (on GaAs substrate) light emitting diode chip.
The Green source color devices are made with InGaAlP on GaAs substrate Light Emitting Diode.

Package Dimensions

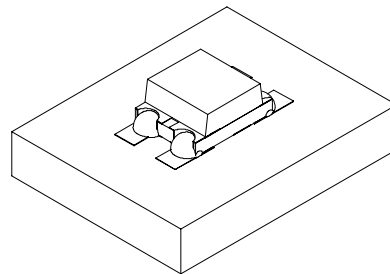
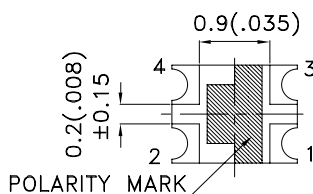
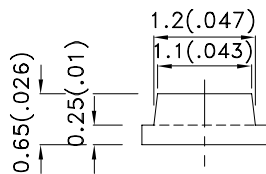
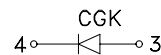
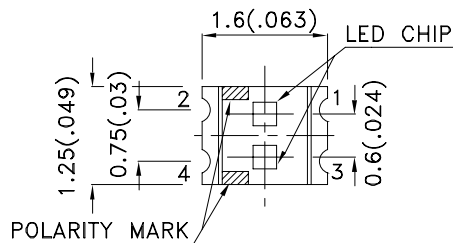

Notes:

1. All dimensions are in millimeters (inches).
2. Tolerance is $\pm 0.2(0.008)$ unless otherwise noted.
3. Specifications are subject to change without notice.
4. The device has a single mounting surface. The device must be mounted according to the specifications.



Selection Guide

Part No.	Dice	Lens Type	Iv (mcd) [2] @ 20mA		Viewing Angle [1]
			Min.	Typ.	2θ1/2
APTB1612SYKCGKC-F01	Super Bright Yellow (InGaAlP)	WATER CLEAR	36	100	120°
	Green (InGaAlP)		18	50	

Notes:

1. θ1/2 is the angle from optical centerline where the luminous intensity is 1/2 the optical centerline value.
2. Luminous intensity/ luminous Flux: +/-15%.

Electrical / Optical Characteristics at TA=25°C

Symbol	Parameter	Device	Typ.	Max.	Units	Test Conditions
λ _{peak}	Peak Wavelength	Super Bright Yellow Green	590 574		nm	I _F =20mA
λ _D [1]	Dominant Wavelength	Super Bright Yellow Green	590 570		nm	I _F =20mA
Δλ _{1/2}	Spectral Line Half-width	Super Bright Yellow Green	20 20		nm	I _F =20mA
C	Capacitance	Super Bright Yellow Green	20 15		pF	V _F =0V;f=1MHz
V _F [2]	Forward Voltage	Super Bright Yellow Green	2 2.1	2.5 2.5	V	I _F =20mA
I _R	Reverse Current	Super Bright Yellow Green		10 10	μA	V _R = 5V

Notes:

1. Wavelength: +/-1nm.
2. Forward Voltage: +/-0.1V.

Absolute Maximum Ratings at TA=25°C

Parameter	Super Bright Yellow	Green	Units
Power dissipation	75	75	mW
DC Forward Current	30	30	mA
Peak Forward Current [1]	175	150	mA
Reverse Voltage	5		V
Operating Temperature	-40°C To +85°C		
Storage Temperature	-40°C To +85°C		

Note:

1. 1/10 Duty Cycle, 0.1ms Pulse Width.

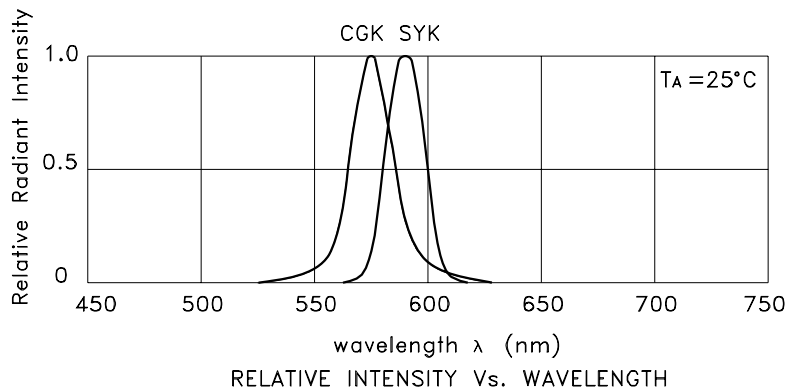

APTB1612SYKCGKC-F01
Super Bright Yellow

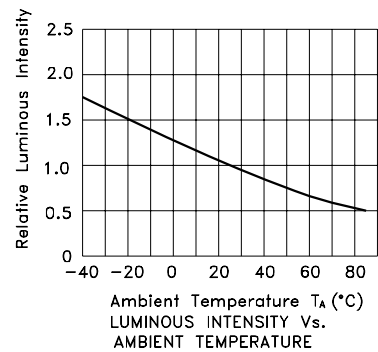
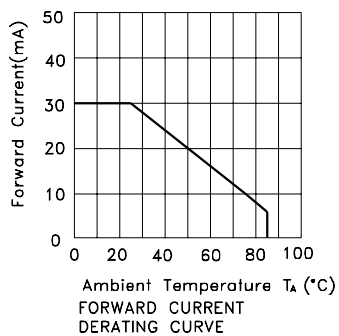
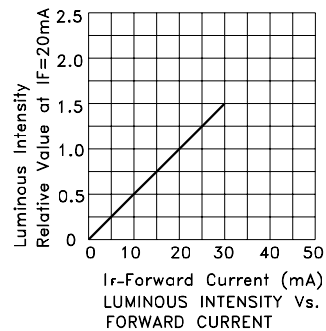
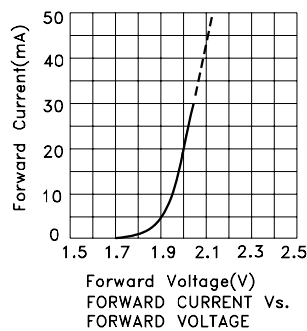

Green

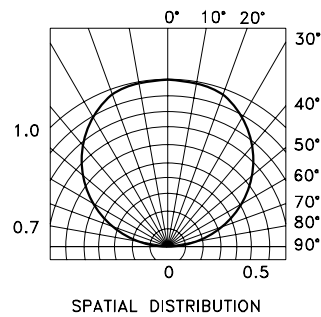
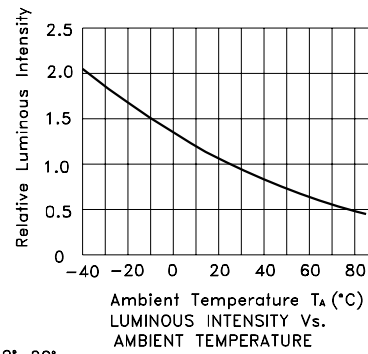
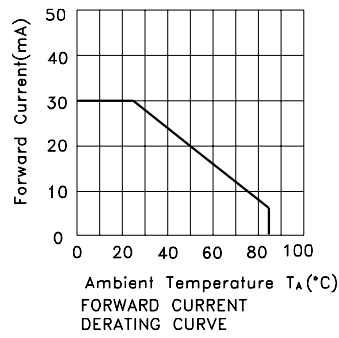
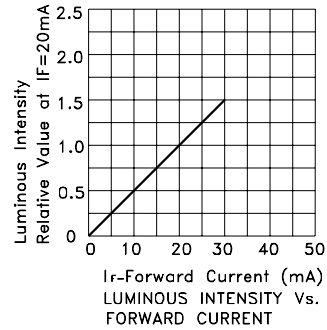
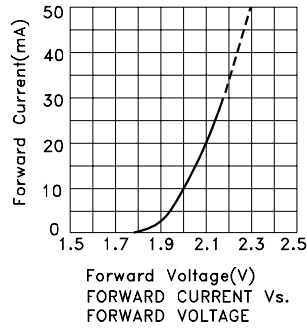

APTB1612SYKCGKC-F01

Reflow Soldering Profile For Lead-free SMT Process.

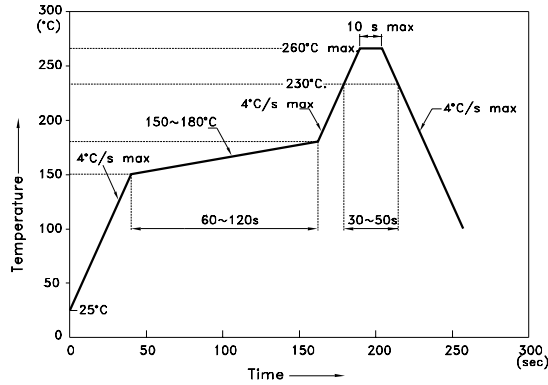

NOTES:

1. We recommend the reflow temperature 245°C(+/-5°C). The maximum soldering temperature should be limited to 260°C.
2. Don't cause stress to the epoxy resin while it is exposed to high temperature.
3. Number of reflow process shall be 2 times or less.

Recommended Soldering Pattern (Units : mm; Tolerance: ± 0.1)

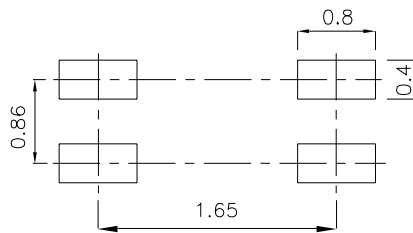

Tape Specifications (Units : mm)

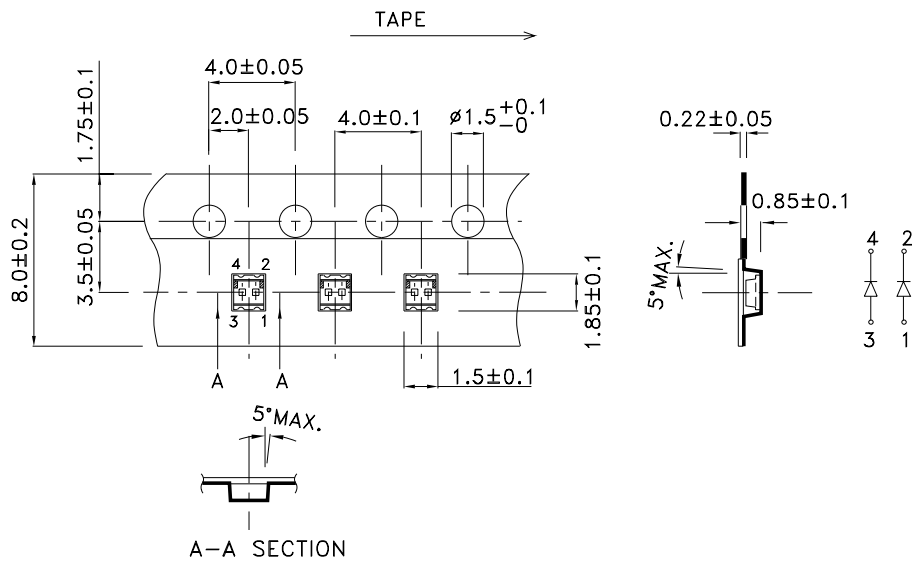

Kingbright

PACKING & LABEL SPECIFICATIONS

APTB1612SYKCGKC-F01

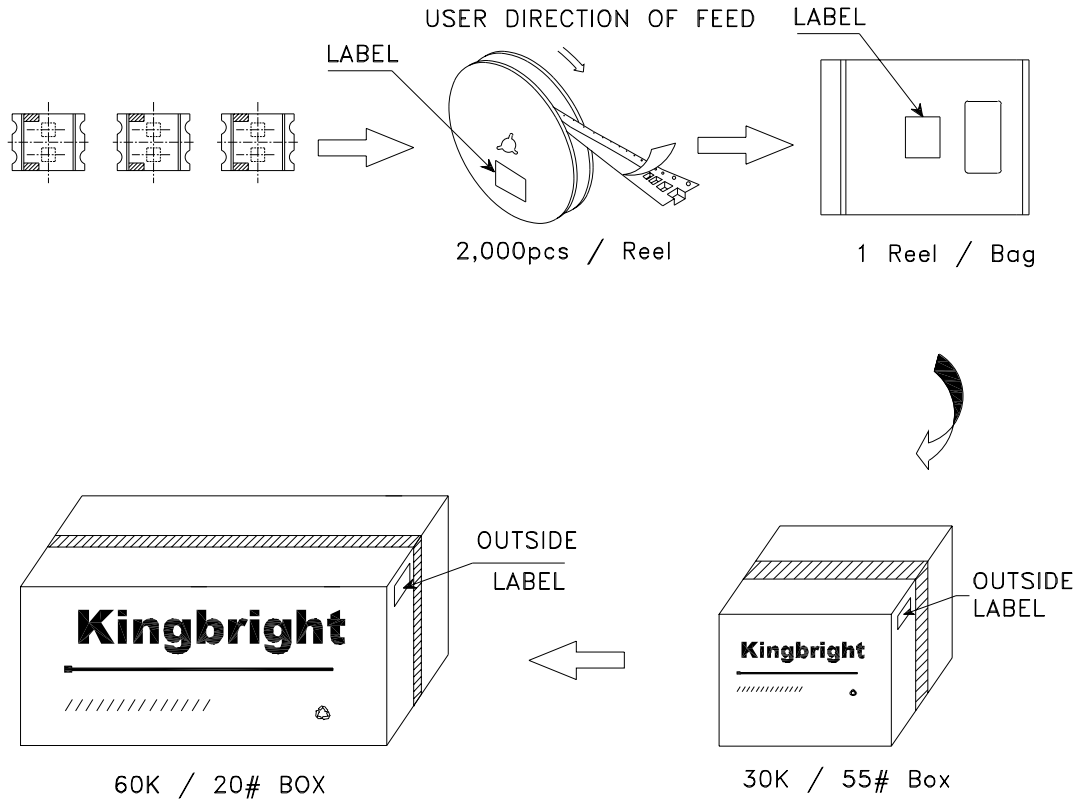

<h1>Kingbright</h1>	
P/NO: APTB1612xxx	
QTY: 2,000 pcs	Q.C. Q C xx xx xxxx PASSED
S/N: XXXX	
CODE: XXX	
LOT NO:	
 xxxxxxxxxxxxxxxxxxxxxxxxxxxxxxxxxxxx	
MADE IN CHINA	RoHS Compliant