

**Full - bridge  
NPT IGBT Power Module**

**$V_{CES} = 600V$   
 $I_C = 180A @ T_c = 80^\circ C$**

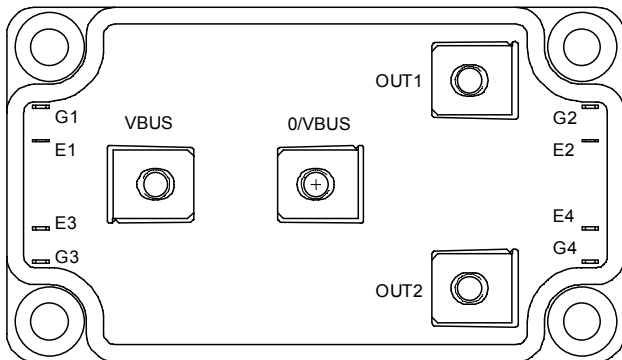
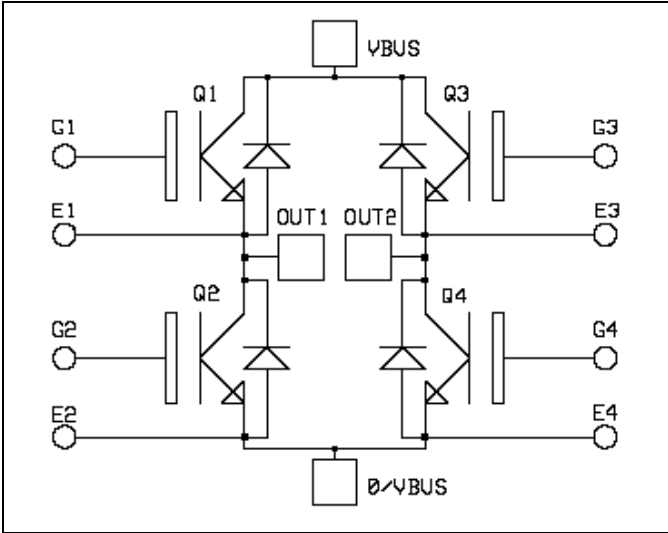

**Application**

- Welding converters
- Switched Mode Power Supplies
- Uninterruptible Power Supplies
- Motor control

**Features**

- Non Punch Through (NPT) THUNDERBOLT IGBT®
  - Low voltage drop
  - Low tail current
  - Switching frequency up to 100 kHz
  - Soft recovery parallel diodes
  - Low diode VF
  - Low leakage current
  - Avalanche energy rated
  - RBSOA and SCSOA rated
- Kelvin emitter for easy drive
- Very low stray inductance
  - Symmetrical design
  - M5 power connectors
- High level of integration

**Benefits**

- Outstanding performance at high frequency operation
- Stable temperature behavior
- Very rugged
- Direct mounting to heatsink (isolated package)
- Low junction to case thermal resistance
- Easy paralleling due to positive TC of VCESat

**Absolute maximum ratings**

Symbol	Parameter	Max ratings	Unit
$V_{CES}$	Collector - Emitter Breakdown Voltage	600	V
$I_C$	Continuous Collector Current	$T_c = 25^\circ C$	220
		$T_c = 80^\circ C$	180
$I_{CM}$	Pulsed Collector Current	$T_c = 25^\circ C$	630
$V_{GE}$	Gate - Emitter Voltage	$\pm 20$	V
$P_D$	Maximum Power Dissipation	$T_c = 25^\circ C$	833
RBSOA	Reverse Bias Safe Operating Area	$T_j = 150^\circ C$	630A @ 600V

**CAUTION:** These Devices are sensitive to Electrostatic Discharge. Proper Handling Procedures Should Be Followed.

All ratings @  $T_j = 25^\circ\text{C}$  unless otherwise specified

## Electrical Characteristics

Symbol	Characteristic	Test Conditions	Min	Typ	Max	Unit
$BV_{CES}$	Collector - Emitter Breakdown Voltage	$V_{GE} = 0\text{V}, I_C = 150\mu\text{A}$	600			V
$I_{CES}$	Zero Gate Voltage Collector Current	$V_{GE} = 0\text{V}$			150	$\mu\text{A}$
		$V_{CE} = 600\text{V}$			3000	
$V_{CE(on)}$	Collector Emitter on Voltage	$V_{GE} = 15\text{V}$		2.0	2.5	V
		$I_C = 180\text{A}$		2.2		
$V_{GE(th)}$	Gate Threshold Voltage	$V_{GE} = V_{CE}, I_C = 2\text{mA}$	3		5	V
$I_{GES}$	Gate - Emitter Leakage Current	$V_{GE} = \pm 20\text{V}, V_{CE} = 0\text{V}$			$\pm 200$	nA

## Dynamic Characteristics

Symbol	Characteristic	Test Conditions	Min	Typ	Max	Unit	
$C_{ies}$	Input Capacitance	$V_{GE} = 0\text{V}$		8.6		nF	
$C_{oes}$	Output Capacitance	$V_{CE} = 25\text{V}$		0.94			
$C_{res}$	Reverse Transfer Capacitance	$f = 1\text{MHz}$		0.8			
$Q_g$	Total gate charge	$V_{GS} = 15\text{V}$		660		nC	
$Q_{ge}$	Gate - Emitter Charge	$V_{Bus} = 300\text{V}$		580			
$Q_{gc}$	Gate - Collector Charge	$I_C = 180\text{A}$		400			
$T_{d(on)}$	Turn-on Delay Time	Inductive Switching ( $25^\circ\text{C}$ ) $V_{GE} = 15\text{V}$ $V_{Bus} = 400\text{V}$ $I_C = 180\text{A}$ $R_G = 2.5\Omega$		26		ns	
$T_r$	Rise Time			25			
$T_{d(off)}$	Turn-off Delay Time			150			
$T_f$	Fall Time			30			
$E_{on}$	Turn-on Switching Energy ❶			6.74			mJ
$E_{off}$	Turn-off Switching Energy ❷			5.74			
$T_{d(on)}$	Turn-on Delay Time	Inductive Switching ( $125^\circ\text{C}$ ) $V_{GE} = 15\text{V}$ $V_{Bus} = 400\text{V}$ $I_C = 180\text{A}$ $R_G = 2.5\Omega$		26		ns	
$T_r$	Rise Time			25			
$T_{d(off)}$	Turn-off Delay Time			170			
$T_f$	Fall Time			40			
$E_{on}$	Turn-on Switching Energy ❶			8.6			mJ
$E_{off}$	Turn-off Switching Energy ❷			7			

## Reverse diode ratings and characteristics

Symbol	Characteristic	Test Conditions	Min	Typ	Max	Unit
$I_{F(AV)}$	Maximum Average Forward Current	50% duty cycle $T_c = 80^\circ\text{C}$		200		A
$V_F$	Diode Forward Voltage	$I_F = 200\text{A}$		1.6	1.8	V
		$I_F = 400\text{A}$		1.9		
		$I_F = 200\text{A}$	$T_j = 125^\circ\text{C}$		1.4	
$t_{rr}$	Reverse Recovery Time	$I_F = 200\text{A}$	$T_j = 25^\circ\text{C}$	180		ns
		$V_R = 400\text{V}$ $di/dt = 400\text{A}/\mu\text{s}$	$T_j = 125^\circ\text{C}$	220		
$Q_{rr}$	Reverse Recovery Charge	$I_F = 200\text{A}$	$T_j = 25^\circ\text{C}$	780		nC
		$V_R = 400\text{V}$ $di/dt = 400\text{A}/\mu\text{s}$	$T_j = 125^\circ\text{C}$	2900		

❶  $E_{on}$  includes diode reverse recovery

❷ In accordance with JEDEC standard JESD24-1



**Typical Performance Curve**

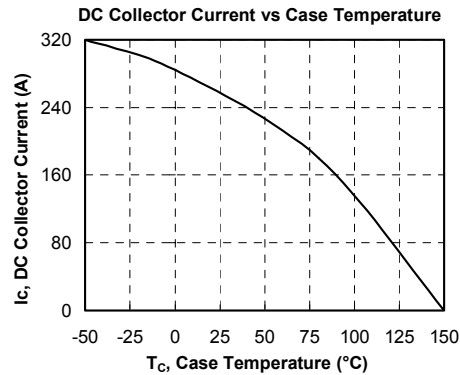
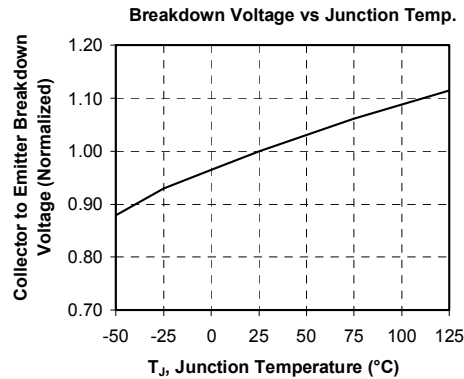
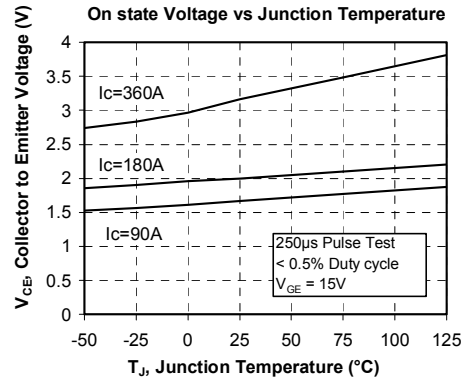
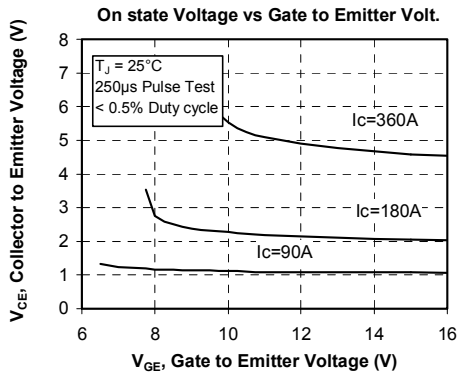
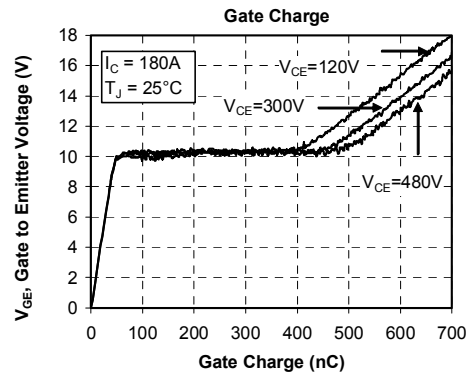
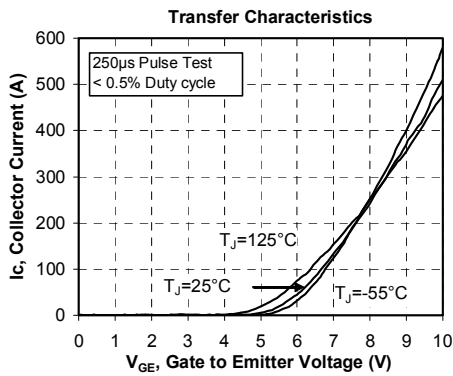
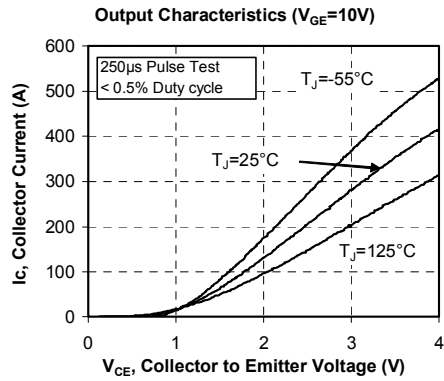
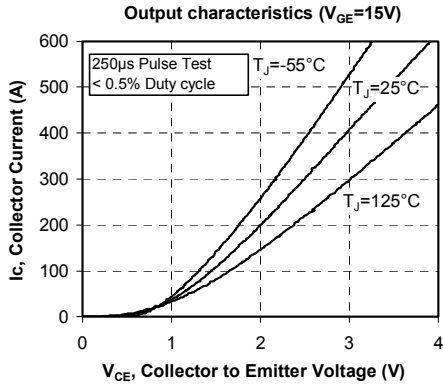

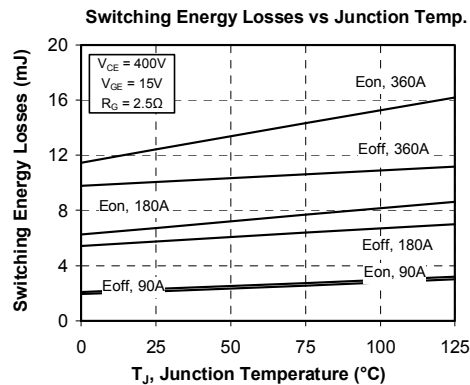
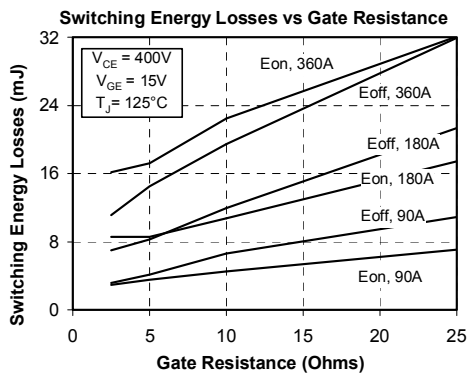
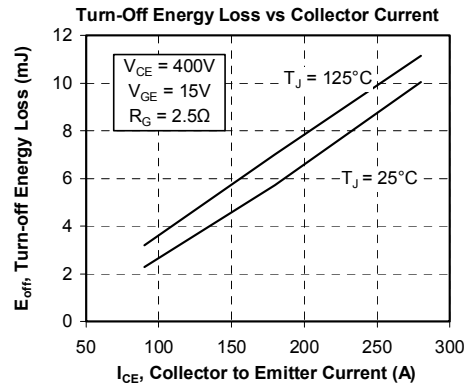
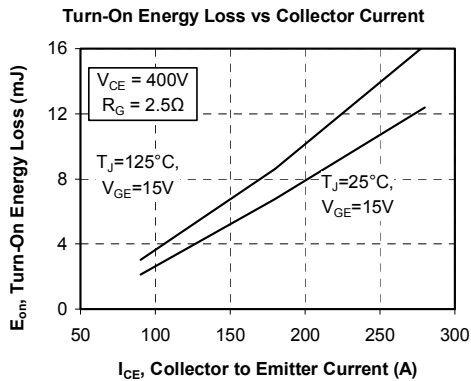
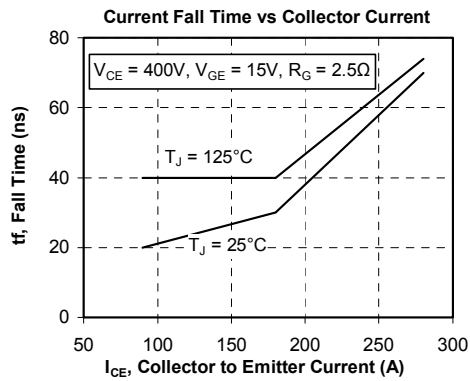
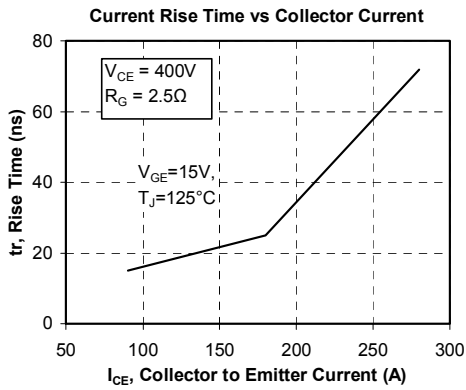
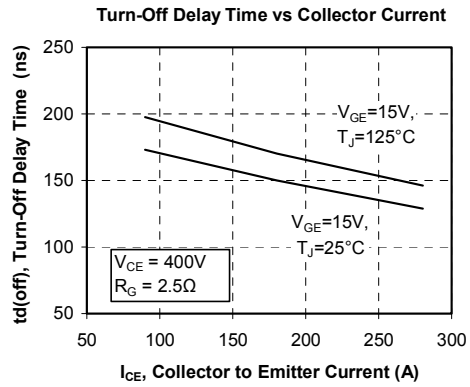
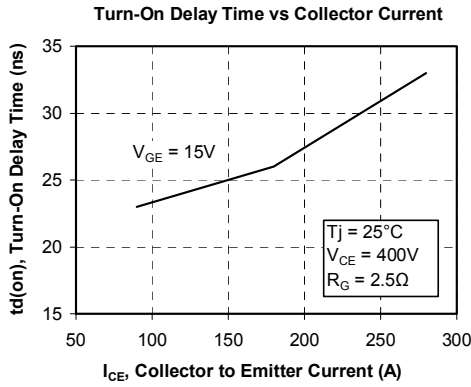

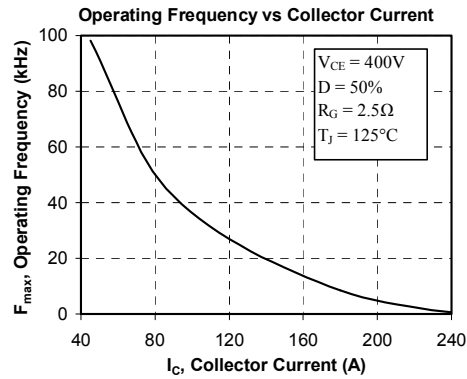
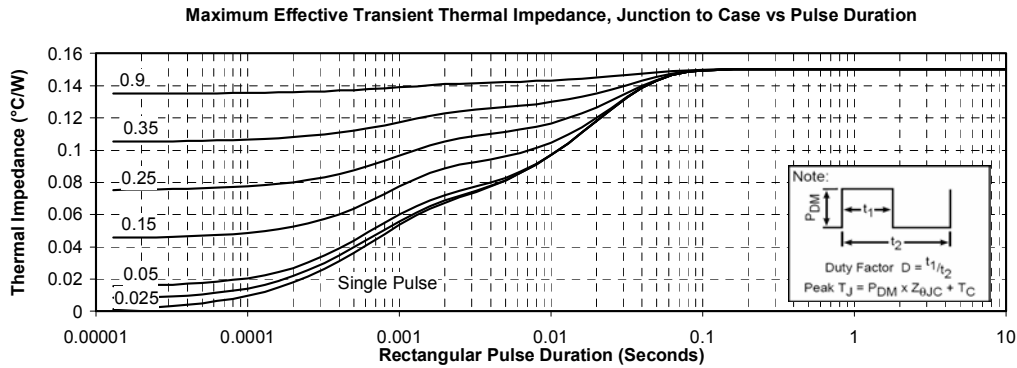
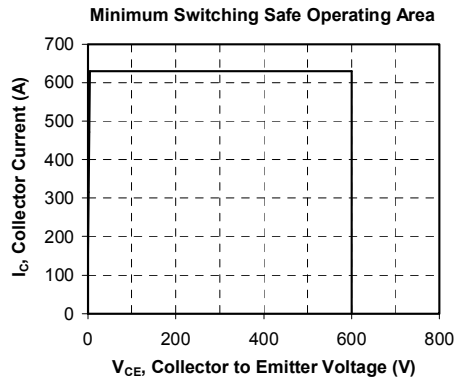
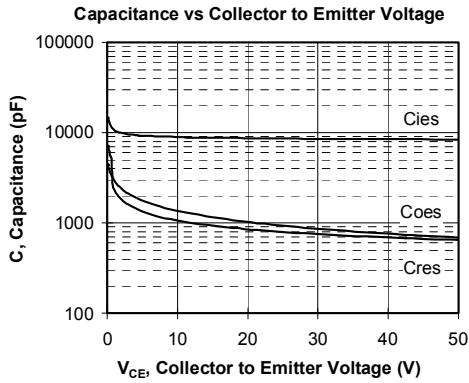

APT reserves the right to change, without notice, the specifications and information contained herein

APT's products are covered by one or more of U.S patents 4,895,810 5,045,903 5,089,434 5,182,234 5,019,522 5,262,336 6,503,786 5,256,583 4,748,103 5,283,202 5,231,474 5,434,095 5,528,058 and foreign patents. U.S and Foreign patents pending. All Rights Reserved.