

**Asymmetrical - Bridge  
Fast Trench + Field Stop IGBT®  
Power Module**

**$V_{CES} = 1200V$   
 $I_C = 75A @ T_c = 80^\circ C$**

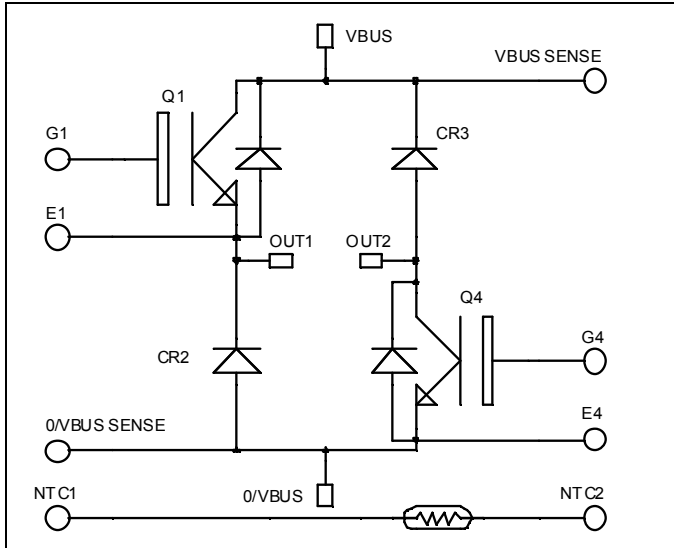

### Application

- Welding converters
- Switched Mode Power Supplies
- Switched Reluctance Motor Drives

### Features

- Fast Trench + Field Stop IGBT® Technology
  - Low voltage drop
  - Low tail current
  - Switching frequency up to 20 kHz
  - Soft recovery parallel diodes
  - Low diode VF
  - Low leakage current
  - Avalanche energy rated
  - RBSOA and SCSOA rated
- Kelvin emitter for easy drive
- Very low stray inductance
  - Symmetrical design
  - Lead frames for power connections
- High level of integration
- Internal thermistor for temperature monitoring

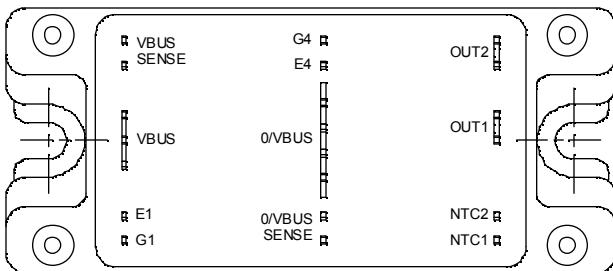

### Benefits

- Stable temperature behavior
- Very rugged
- Solderable terminals for easy PCB mounting
- Direct mounting to heatsink (isolated package)
- Low junction to case thermal resistance
- Easy paralleling due to positive TC of VCEsat
- Low profile
- RoHS Compliant

### Absolute maximum ratings

| Symbol    | Parameter                             | Max ratings         | Unit         |
|-----------|---------------------------------------|---------------------|--------------|
| $V_{CES}$ | Collector - Emitter Breakdown Voltage | 1200                | V            |
| $I_C$     | Continuous Collector Current          | $T_C = 25^\circ C$  | 110          |
|           |                                       | $T_C = 80^\circ C$  | 75           |
| $I_{CM}$  | Pulsed Collector Current              | $T_C = 25^\circ C$  | 175          |
| $V_{GE}$  | Gate - Emitter Voltage                | $\pm 20$            | V            |
| $P_D$     | Maximum Power Dissipation             | $T_C = 25^\circ C$  | 357          |
| RBSOA     | Reverse Bias Safe Operating Area      | $T_j = 125^\circ C$ | 150A @ 1150V |

**CAUTION:** These Devices are sensitive to Electrostatic Discharge. Proper Handling Procedures Should Be Followed. See application note APT0502 on [www.microsemi.com](http://www.microsemi.com)

All ratings @  $T_j = 25^\circ\text{C}$  unless otherwise specified

**Electrical Characteristics**

| Symbol        | Characteristic                       | Test Conditions                                | Min   | Typ        | Max | Unit          |
|---------------|--------------------------------------|--|---|------------|-----|---------------|
| $I_{CES}$     | Zero Gate Voltage Collector Current  | $V_{GE} = 0\text{V}$ , $V_{CE} = 1200\text{V}$ |   |            | 250 | $\mu\text{A}$ |
| $V_{CE(sat)}$ | Collector Emitter saturation Voltage | $V_{GE} = 15\text{V}$<br>$I_C = 75\text{A}$    | $T_j = 25^\circ\text{C}$<br>$T_j = 125^\circ\text{C}$ | 1.4<br>2.0 | 2.1 | V             |
| $V_{GE(th)}$  | Gate Threshold Voltage               | $V_{GE} = V_{CE}$ , $I_C = 3\text{mA}$         | 5.0   |            | 6.5 | V             |
| $I_{GES}$     | Gate – Emitter Leakage Current       | $V_{GE} = 20\text{V}$ , $V_{CE} = 0\text{V}$   |   |            | 400 | nA            |

**Dynamic Characteristics**

| Symbol       | Characteristic               | Test Conditions  | Min                       | Typ  | Max | Unit |
|--------------|------------------------------|--|---------------------------|------|-----|------|
| $C_{ies}$    | Input Capacitance            | $V_{GE} = 0\text{V}$   |                           | 5340 |     | pF   |
| $C_{oes}$    | Output Capacitance           | $V_{CE} = 25\text{V}$  |                           | 280  |     |      |
| $C_{res}$    | Reverse Transfer Capacitance | $f = 1\text{MHz}$  |                           | 240  |     |      |
| $T_{d(on)}$  | Turn-on Delay Time           | Inductive Switching ( $25^\circ\text{C}$ )                                 |                           | 260  |     | ns   |
| $T_r$        | Rise Time                    | $V_{GE} = \pm 15\text{V}$<br>$V_{Bus} = 600\text{V}$<br>$I_C = 75\text{A}$ |                           | 30   |     |      |
| $T_{d(off)}$ | Turn-off Delay Time          | $R_G = 4.7\Omega$  |                           | 420  |     |      |
| $T_f$        | Fall Time                    |  |                           | 70   |     |      |
| $T_{d(on)}$  | Turn-on Delay Time           | Inductive Switching ( $125^\circ\text{C}$ )                                |                           | 285  |     | ns   |
| $T_r$        | Rise Time                    | $V_{GE} = \pm 15\text{V}$<br>$V_{Bus} = 600\text{V}$<br>$I_C = 75\text{A}$ |                           | 50   |     |      |
| $T_{d(off)}$ | Turn-off Delay Time          | $R_G = 4.7\Omega$  |                           | 520  |     |      |
| $T_f$        | Fall Time                    |  |                           | 90   |     |      |
| $E_{on}$     | Turn-on Switching Energy     | $V_{GE} = \pm 15\text{V}$<br>$V_{Bus} = 600\text{V}$<br>$I_C = 75\text{A}$ | $T_j = 125^\circ\text{C}$ | 7    |     | mJ   |
| $E_{off}$    | Turn-off Switching Energy    | $R_G = 4.7\Omega$  | $T_j = 125^\circ\text{C}$ | 8.1  |     |      |

**Diode ratings and characteristics**

| Symbol    | Characteristic                          | Test Conditions   | Min   | Typ        | Max        | Unit          |
|-----------|---|---|---|------------|------------|---------------|
| $V_{RRM}$ | Maximum Peak Repetitive Reverse Voltage |   | 1200  |            |            | V             |
| $I_{RM}$  | Maximum Reverse Leakage Current         | $V_R = 1200\text{V}$  | $T_j = 25^\circ\text{C}$<br>$T_j = 125^\circ\text{C}$ |            | 250<br>500 | $\mu\text{A}$ |
| $I_F$     | DC Forward Current                      |   | $T_c = 80^\circ\text{C}$                              | 75         |            | A             |
| $V_F$     | Diode Forward Voltage                   | $I_F = 75\text{A}$  | $T_j = 25^\circ\text{C}$<br>$T_j = 125^\circ\text{C}$ | 1.5<br>1.4 | 2.0        | V             |
| $t_{rr}$  | Reverse Recovery Time                   | $I_F = 75\text{A}$<br>$V_R = 600\text{V}$<br>$di/dt = 2000\text{A}/\mu\text{s}$ | $T_j = 25^\circ\text{C}$<br>$T_j = 125^\circ\text{C}$ | 150<br>250 |            | ns            |
| $Q_{rr}$  | Reverse Recovery Charge                 |   | $T_j = 25^\circ\text{C}$<br>$T_j = 125^\circ\text{C}$ | 7<br>13.5  |            | $\mu\text{C}$ |
| $E_r$     | Reverse Recovery Energy                 |   | $T_j = 25^\circ\text{C}$<br>$T_j = 125^\circ\text{C}$ | 3.7<br>7.2 |            | mJ            |

**Temperature sensor NTC** (see application note APT0406 on [www.microsemi.com](http://www.microsemi.com) for more information).

**Symbol Characteristic** **Min Typ Max Unit**

| Symbol             | Characteristic             | Min | Typ  | Max | Unit |
|--------------------|----------------------------|-----|------|-----|------|
| R <sub>25</sub>    | Resistance @ 25°C          |     | 50   |     | kΩ   |
| B <sub>25/85</sub> | T <sub>25</sub> = 298.15 K |     | 3952 |     | K    |

$$R_T = \frac{R_{25}}{\exp\left[B_{25/85}\left(\frac{1}{T} - \frac{1}{T_{25}}\right)\right]}$$

T: Thermistor temperature  
 R<sub>T</sub>: Thermistor value at T

## Thermal and package characteristics

**Symbol Characteristic** **Min Typ Max Unit**

| Symbol            | Characteristic   | Min   | Typ         | Max  | Unit |     |     |
|-------------------|--|-------|-------------|------|------|-----|-----|
| R <sub>thJC</sub> | Junction to Case Thermal Resistance  | IGBT  |             | 0.35 | °C/W |     |     |
|                   |  | Diode |             | 0.48 |      |     |     |
| V <sub>ISOL</sub> | RMS Isolation Voltage, any terminal to case t=1 min, I <sub>isol</sub> <1mA, 50/60Hz | 2500  |             |      | V    |     |     |
| T <sub>J</sub>    | Operating junction temperature range   | -40   |             | 150  | °C   |     |     |
| T <sub>STG</sub>  | Storage Temperature Range  | -40   |             | 125  |      |     |     |
| T <sub>C</sub>    | Operating Case Temperature   | -40   |             | 125  |      |     |     |
| Torque            | Mounting torque  |       | To Heatsink | M5   | 2.5  | 4.7 | N.m |
| Wt                | Package Weight   |       |             |      |      | 160 | g   |

## SP4 Package outline (dimensions in mm)

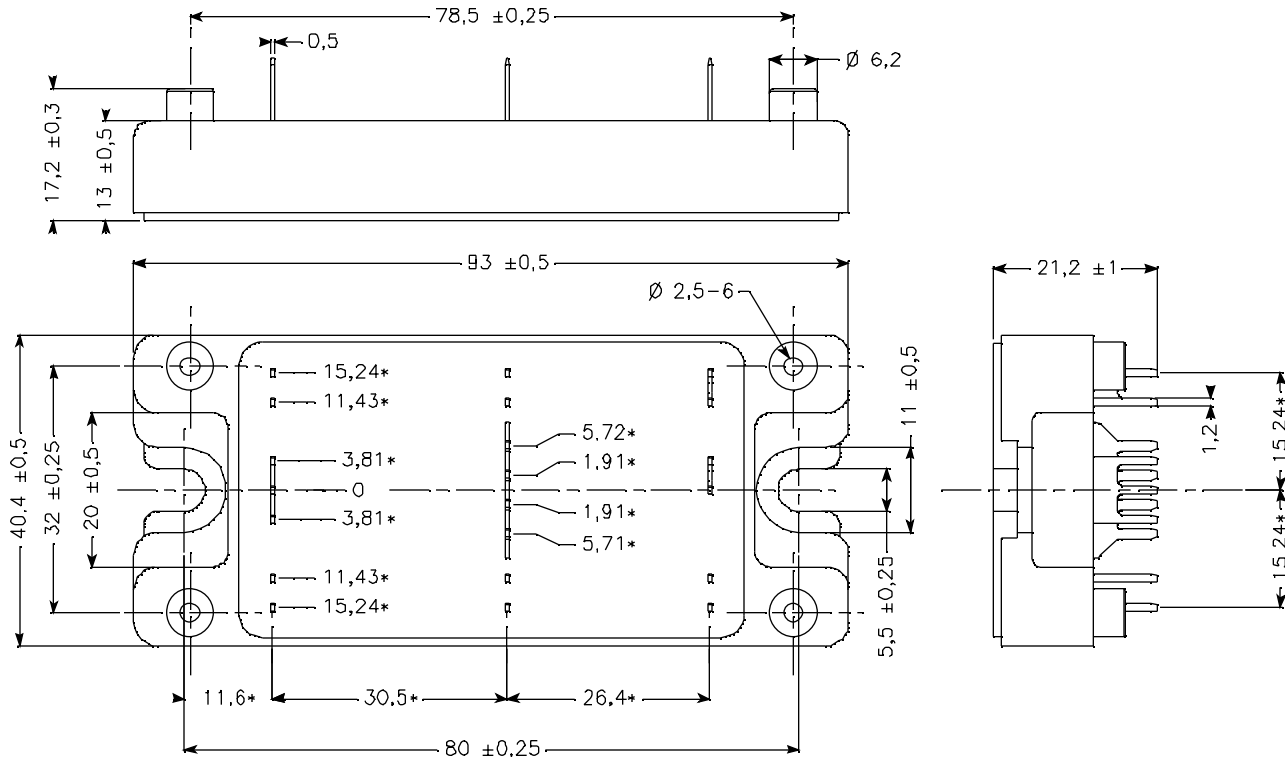

ALL DIMENSIONS MARKED "\*" ARE TOLERENCED AS:  $\text{M} \pm 0.1$

See application note APT0501 - Mounting Instructions for SP4 Power Modules on [www.microsemi.com](http://www.microsemi.com)

## Typical Performance Curve

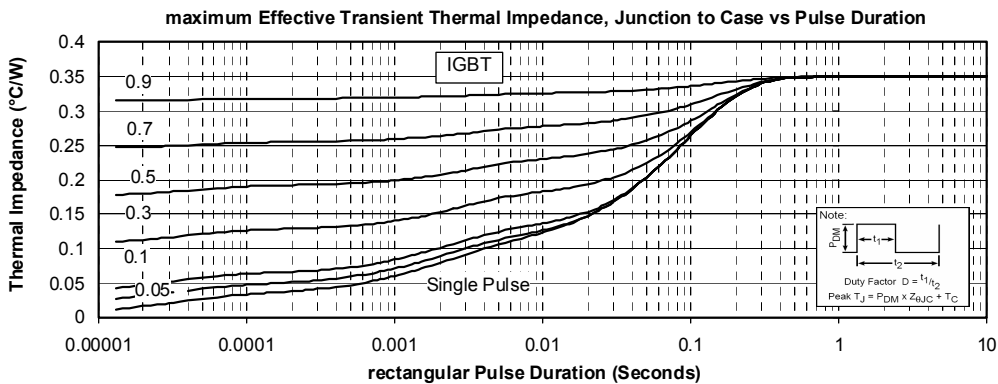
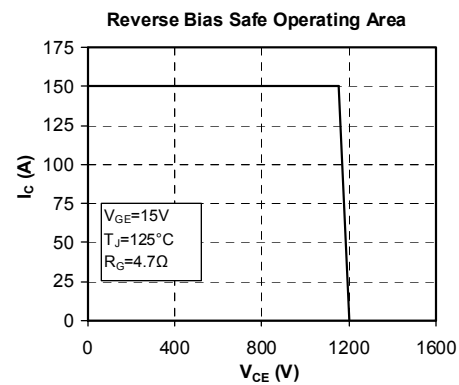
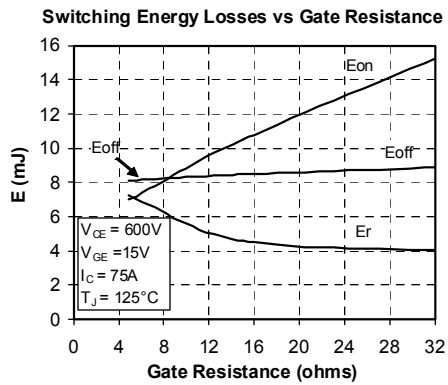
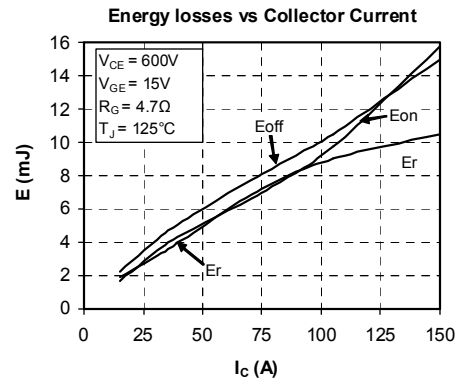
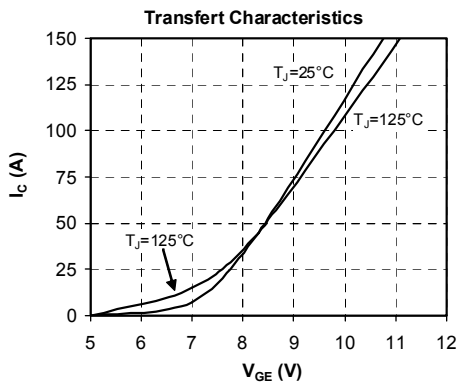
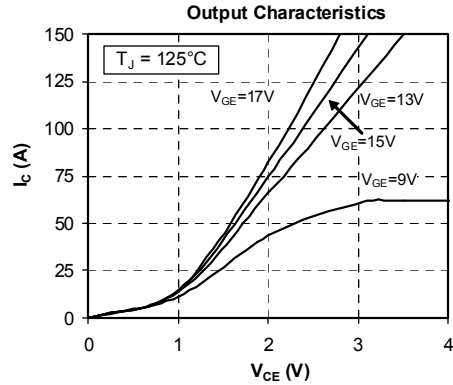
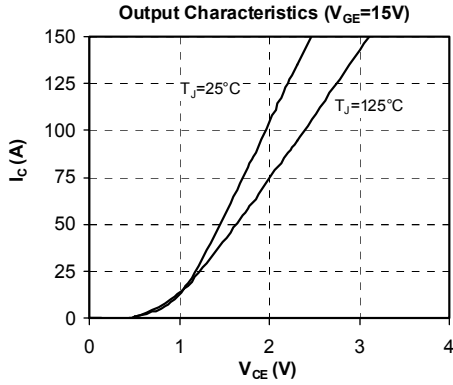

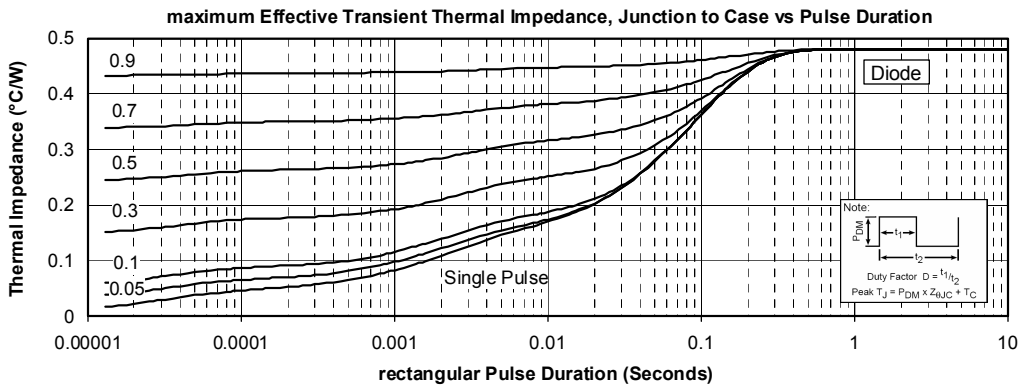
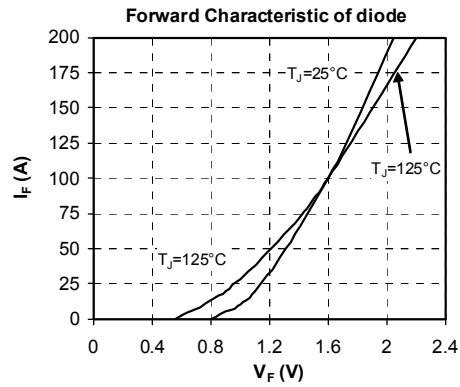
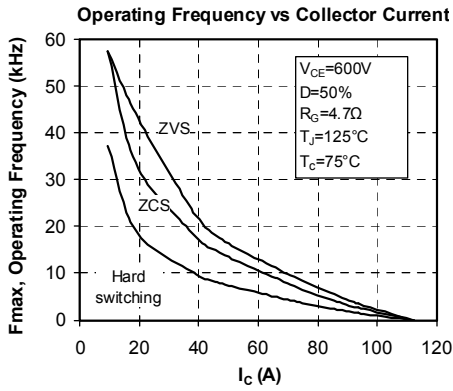

Microsemi reserves the right to change, without notice, the specifications and information contained herein

Microsemi's products are covered by one or more of U.S. patents 4,895,810 5,045,903 5,089,434 5,182,234 5,019,522 5,262,336 6,503,786 5,256,583 4,748,103 5,283,202 5,231,474 5,434,095 5,528,058 and foreign patents. U.S. and Foreign patents pending. All Rights Reserved.