

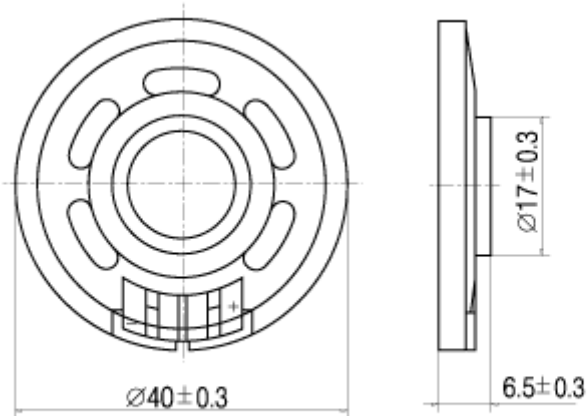

Type	BMS-4011
Rated Impedance(Ω)	16 \pm 15%
Rated(Max.) Power(W)	0.15(0.3)
Resonant Frequency(Hz)	450 \pm 20%
Rated Freq.Range(Hz)	F ₀ ~3500
Sound Pressure Level(dB)	82 \pm 3
Magnet(g)	0.6
Operating Temperature($^{\circ}$ C)	-10~+40



Unit:mm

