

**Thyristors**

**BT151U series C**

**GENERAL DESCRIPTION**

Passivated thyristors in a plastic envelope, intended for use in applications requiring high bidirectional blocking voltage capability and high thermal cycling performance. Typical applications include motor control, industrial and domestic lighting, heating and static switching.

**QUICK REFERENCE DATA**

SYMBOL	PARAMETER	MAX.	MAX.	MAX.	UNIT
$V_{DRM}$ , $V_{RRM}$	Repetitive peak off-state voltages	<b>500C</b> 500	<b>650C</b> 650	<b>800C</b> 800	V
$I_{T(AV)}$	Average on-state current	7.5	7.5	7.5	A
$I_{T(RMS)}$	RMS on-state current	12	12	12	A
$I_{TSM}$	Non-repetitive peak on-state current	100	100	100	A

**PINNING - SOT533, (I-PAK)**

PIN NUMBER	DESCRIPTION
1	cathode
2	anode
3	gate
tab	anode

**PIN CONFIGURATION**

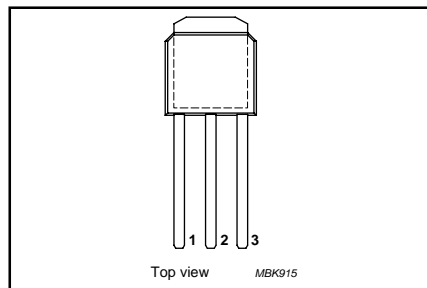

**SYMBOL**

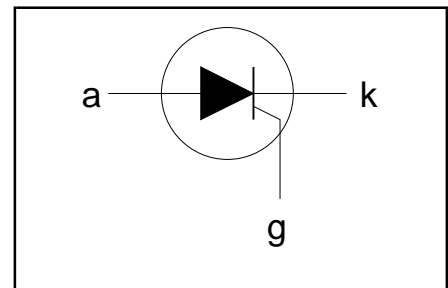

**LIMITING VALUES**

Limiting values in accordance with the Absolute Maximum System (IEC 60134).

SYMBOL	PARAMETER	CONDITIONS	MIN.	MAX.	UNIT
$V_{DRM}$ , $V_{RRM}$	Repetitive peak off-state voltages		-	<b>-500C</b> 500 <sup>1</sup> <b>-650C</b> 650 <sup>1</sup> <b>-800C</b> 800	V
$I_{T(AV)}$	Average on-state current	half sine wave; $T_{mb} \leq 104\text{ °C}$	-	7.5	A
$I_{T(RMS)}$	RMS on-state current	all conduction angles	-	12	A
$I_{TSM}$	Non-repetitive peak on-state current	half sine wave; $T_j = 25\text{ °C}$ prior to surge	-	100	A
		$t = 10\text{ ms}$	-	110	A
		$t = 8.3\text{ ms}$	-	50	A <sup>2</sup> s
$I^2t$	$I^2t$ for fusing	$t = 10\text{ ms}$	-	50	A <sup>2</sup> s
$di_T/dt$	Repetitive rate of rise of on-state current after triggering	$I_{TM} = 20\text{ A}$ ; $I_G = 50\text{ mA}$ ; $di_G/dt = 50\text{ mA}/\mu\text{s}$	-	50	A/ $\mu\text{s}$
$I_{GM}$	Peak gate current		-	2	A
$V_{RGM}$	Peak reverse gate voltage		-	5	V
$P_{GM}$	Peak gate power		-	5	W
$P_{G(AV)}$	Average gate power	over any 20 ms period	-	0.5	W
$T_{stg}$	Storage temperature		-40	150	°C
$T_j$	Junction temperature		-	125	°C

<sup>1</sup> Although not recommended, off-state voltages up to 800V may be applied without damage, but the thyristor may switch to the on-state. The rate of rise of current should not exceed 15 A/ $\mu\text{s}$ .

## Thyristors

## BT151U series C

**THERMAL RESISTANCES**

SYMBOL	PARAMETER	CONDITIONS	MIN.	TYP.	MAX.	UNIT
$R_{th\ j-mb}$	Thermal resistance junction to mounting base	in free air	-	-	1.3	K/W
$R_{th\ j-a}$	Thermal resistance junction to ambient		-	70	-	K/W

**STATIC CHARACTERISTICS** $T_j = 25\text{ °C}$  unless otherwise stated

SYMBOL	PARAMETER	CONDITIONS	MIN.	TYP.	MAX.	UNIT
$I_{GT}$	Gate trigger current	$V_D = 12\text{ V}; I_T = 0.1\text{ A}$	-	2	15	mA
$I_L$	Latching current	$V_D = 12\text{ V}; I_{GT} = 0.1\text{ A}$	-	10	40	mA
$I_H$	Holding current	$V_D = 12\text{ V}; I_{GT} = 0.1\text{ A}$	-	7	20	mA
$V_T$	On-state voltage	$I_T = 23\text{ A}$	-	1.44	1.75	V
$V_{GT}$	Gate trigger voltage	$V_D = 12\text{ V}; I_T = 0.1\text{ A}$	-	0.6	1.5	V
$I_D, I_R$	Off-state leakage current	$V_D = V_{DRM(max)}; I_T = 0.1\text{ A}; T_j = 125\text{ °C}$	0.25	0.4	-	V
		$V_D = V_{DRM(max)}; V_R = V_{RRM(max)}; T_j = 125\text{ °C}$	-	0.1	0.5	mA

**DYNAMIC CHARACTERISTICS** $T_j = 25\text{ °C}$  unless otherwise stated

SYMBOL	PARAMETER	CONDITIONS	MIN.	TYP.	MAX.	UNIT
$dV_D/dt$	Critical rate of rise of off-state voltage	$V_{DM} = 67\% V_{DRM(max)}; T_j = 125\text{ °C};$ exponential waveform				
$t_{gt}$	Gate controlled turn-on time	Gate open circuit	50	130	-	V/ $\mu$ s
		$R_{GK} = 100\ \Omega$	200	1000	-	V/ $\mu$ s
$t_q$	Circuit commutated turn-off time	$I_{TM} = 40\text{ A}; V_D = V_{DRM(max)}; I_G = 0.1\text{ A};$ $di_G/dt = 5\text{ A}/\mu\text{s}$	-	2	-	$\mu$ s
		$V_D = 67\% V_{DRM(max)}; T_j = 125\text{ °C};$ $I_{TM} = 20\text{ A}; V_R = 25\text{ V}; di_{TM}/dt = 30\text{ A}/\mu\text{s};$ $dV_D/dt = 50\text{ V}/\mu\text{s}; R_{GK} = 100\ \Omega$	-	70	-	$\mu$ s

Thyristors

BT151U series C

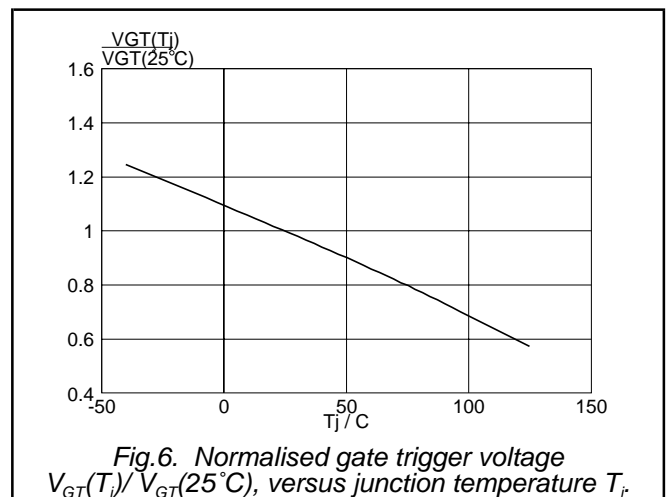
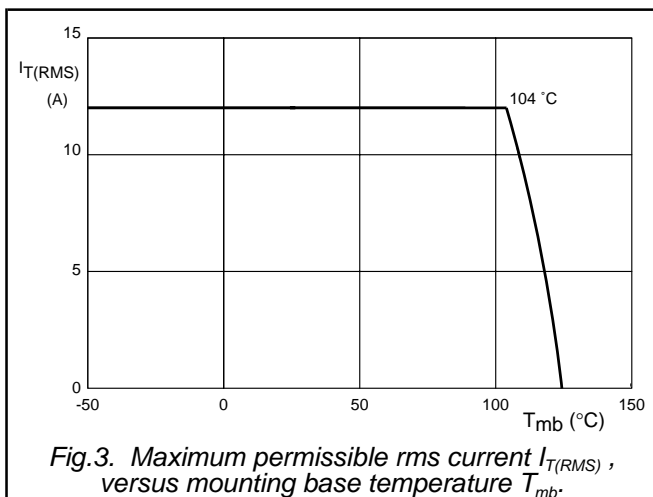
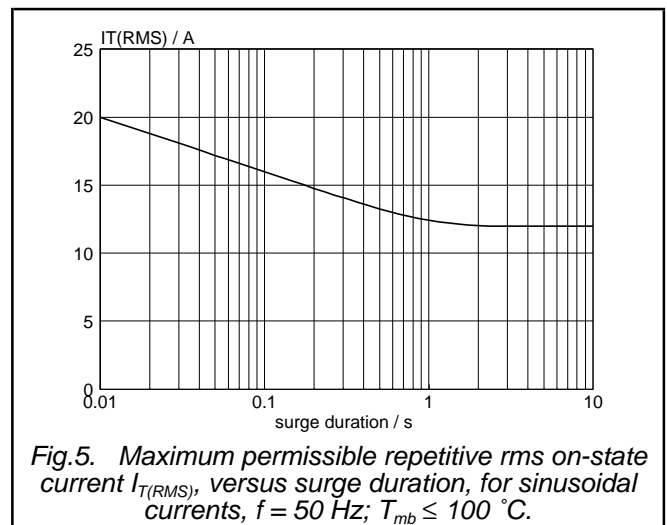
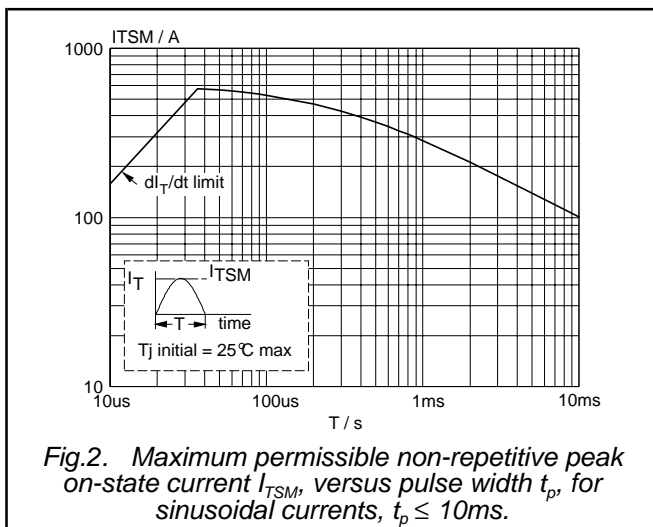
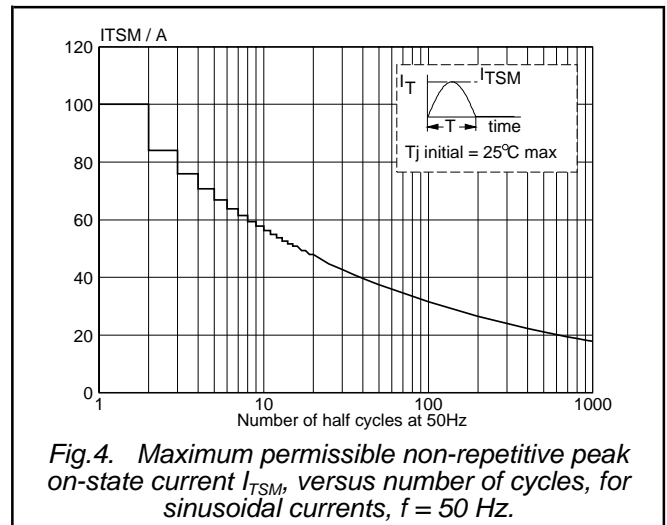
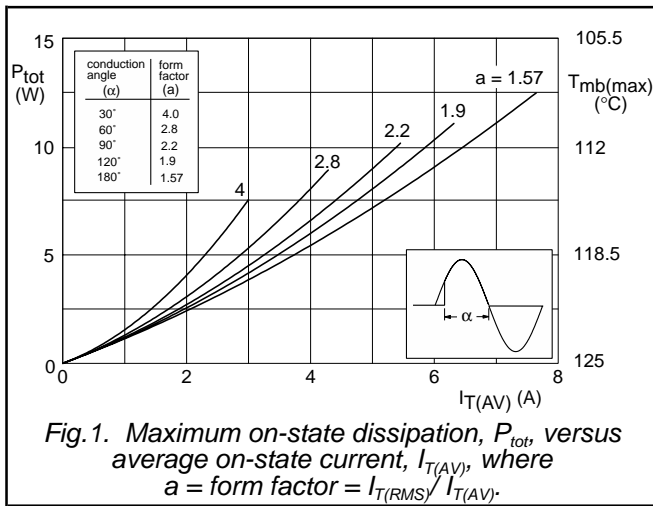

Thyristors

BT151U series C

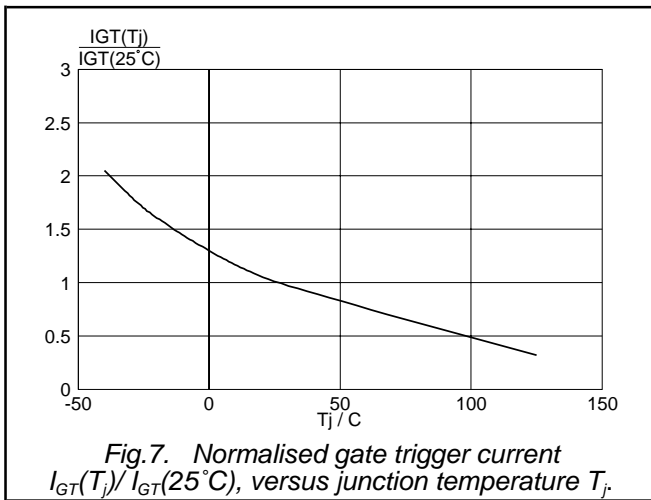

Fig. 7. Normalised gate trigger current  $I_{GT}(T_j)/I_{GT}(25^\circ\text{C})$ , versus junction temperature  $T_j$ .

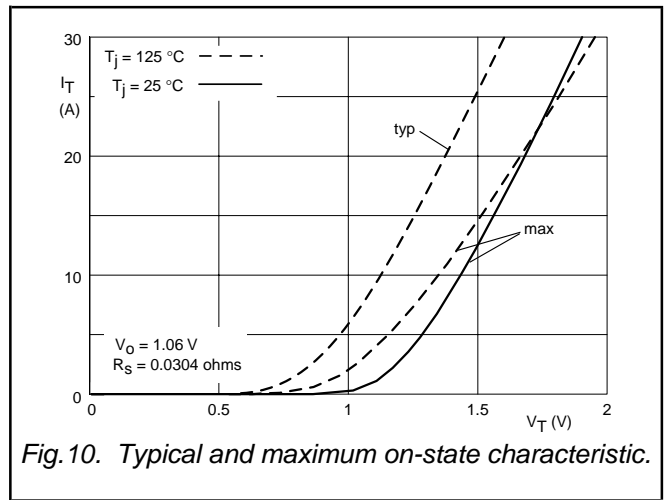

Fig. 10. Typical and maximum on-state characteristic.

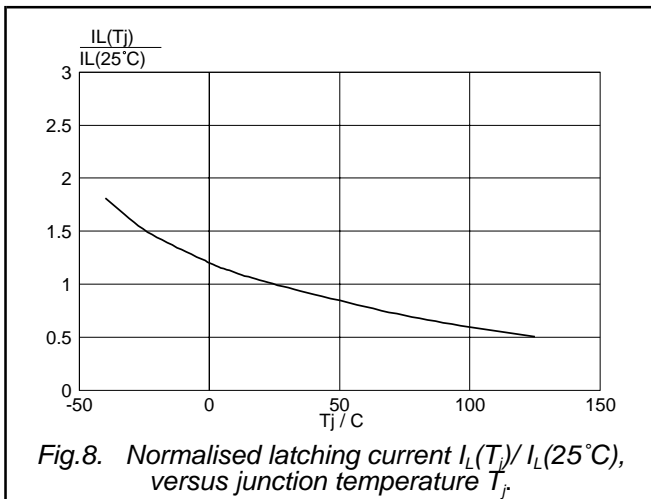

Fig. 8. Normalised latching current  $I_L(T_j)/I_L(25^\circ\text{C})$ , versus junction temperature  $T_j$ .

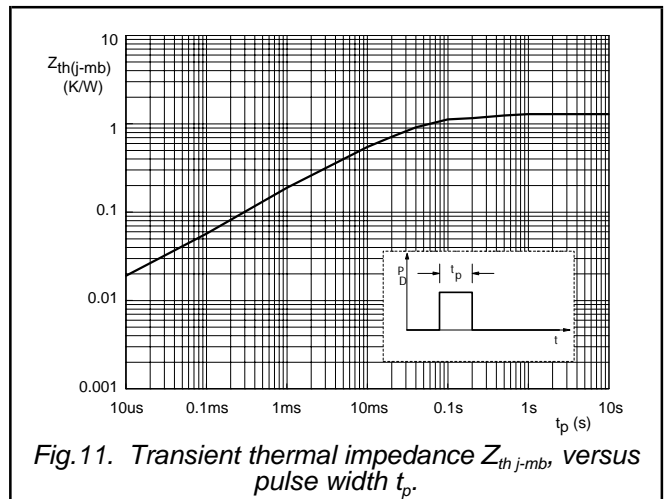

Fig. 11. Transient thermal impedance  $Z_{th(j-mb)}$ , versus pulse width  $t_p$ .

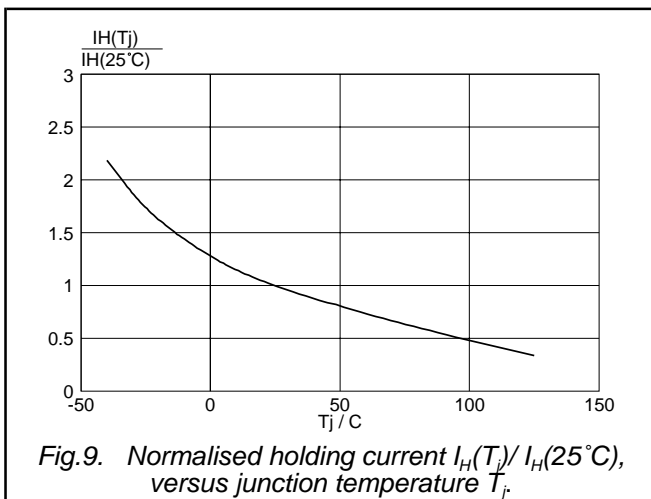

Fig. 9. Normalised holding current  $I_H(T_j)/I_H(25^\circ\text{C})$ , versus junction temperature  $T_j$ .

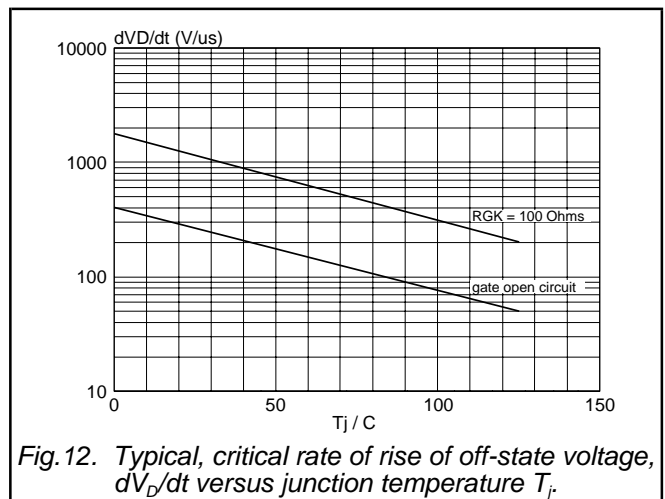

Fig. 12. Typical, critical rate of rise of off-state voltage,  $dV_D/dt$  versus junction temperature  $T_j$ .

**MECHANICAL DATA**

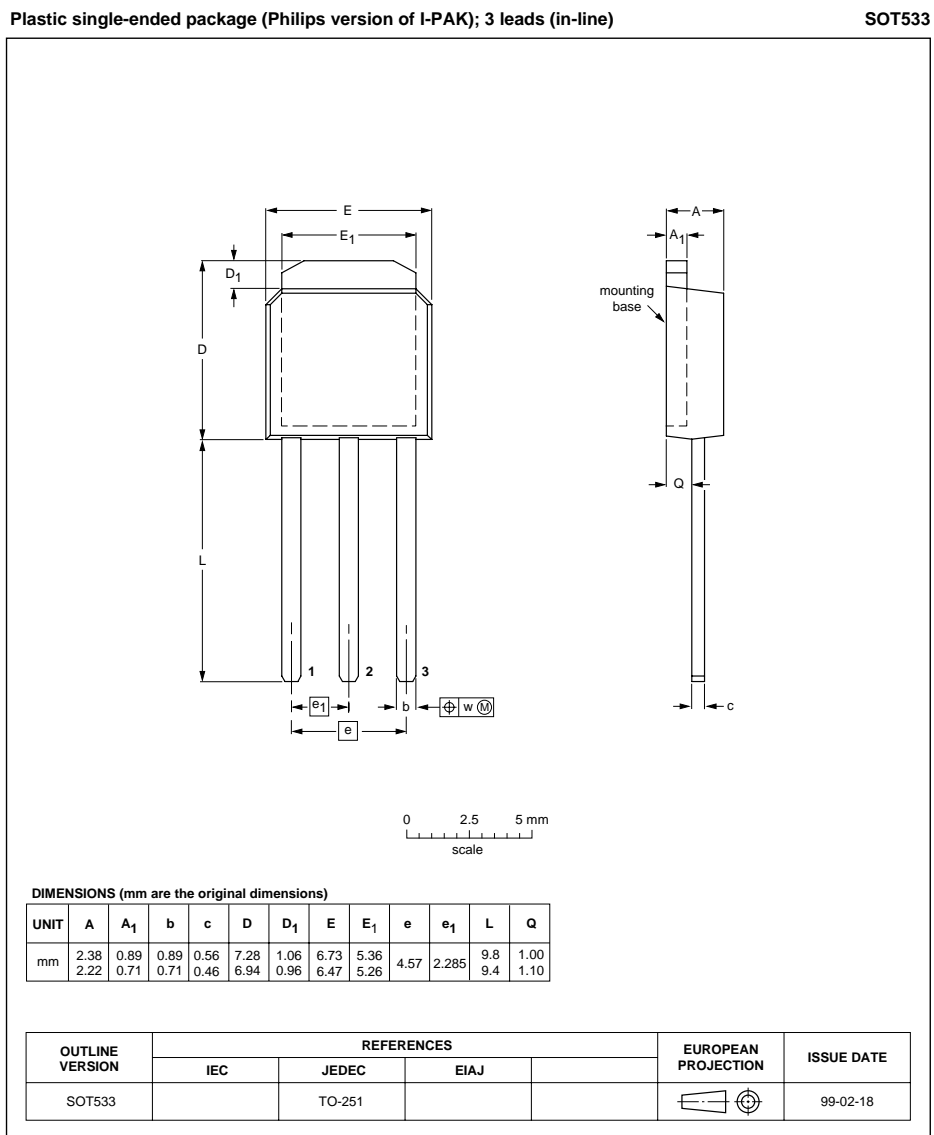

Fig. 13. SOT533, (I-PAK). Pin 2 connected to mounting base.

## Thyristors

## BT151U series C

**DEFINITIONS**

<b>DATA SHEET STATUS</b>		
<b>DATA SHEET STATUS<sup>2</sup></b>	<b>PRODUCT STATUS<sup>3</sup></b>	<b>DEFINITIONS</b>
Objective data	Development	This data sheet contains data from the objective specification for product development. Philips Semiconductors reserves the right to change the specification in any manner without notice
Preliminary data	Qualification	This data sheet contains data from the preliminary specification. Supplementary data will be published at a later date. Philips Semiconductors reserves the right to change the specification without notice, in order to improve the design and supply the best possible product
Product data	Production	This data sheet contains data from the product specification. Philips Semiconductors reserves the right to make changes at any time in order to improve the design, manufacturing and supply. Changes will be communicated according to the Customer Product/Process Change Notification (CPCN) procedure SNW-SQ-650A
<b>Limiting values</b>		
Limiting values are given in accordance with the Absolute Maximum Rating System (IEC 134). Stress above one or more of the limiting values may cause permanent damage to the device. These are stress ratings only and operation of the device at these or at any other conditions above those given in the Characteristics sections of this specification is not implied. Exposure to limiting values for extended periods may affect device reliability.		
<b>Application information</b>		
Where application information is given, it is advisory and does not form part of the specification.		
© Philips Electronics N.V. 2004		
All rights are reserved. Reproduction in whole or in part is prohibited without the prior written consent of the copyright owner.		
The information presented in this document does not form part of any quotation or contract, it is believed to be accurate and reliable and may be changed without notice. No liability will be accepted by the publisher for any consequence of its use. Publication thereof does not convey nor imply any license under patent or other industrial or intellectual property rights.		

**LIFE SUPPORT APPLICATIONS**

These products are not designed for use in life support appliances, devices or systems where malfunction of these products can be reasonably expected to result in personal injury. Philips customers using or selling these products for use in such applications do so at their own risk and agree to fully indemnify Philips for any damages resulting from such improper use or sale.

<sup>2</sup> Please consult the most recently issued datasheet before initiating or completing a design.

<sup>3</sup> The product status of the device(s) described in this datasheet may have changed since this datasheet was published. The latest information is available on the Internet at URL <http://www.semiconductors.philips.com>.