

# C2D10120D–Silicon Carbide Schottky Diode

## ZERO RECOVERY<sup>®</sup> RECTIFIER

$V_{RRM} = 1200\text{ V}$   
 $I_F = 10\text{ A}$   
 $Q_c = 56\text{ nC}$

### Features

- 1200-Volt Schottky Rectifier
- Zero Reverse Recovery
- Zero Forward Recovery
- High-Frequency Operation
- Temperature-Independent Switching Behavior
- Extremely Fast Switching
- Positive Temperature Coefficient on  $V_F$

### Benefits

- Replace Bipolar with Unipolar Rectifiers
- Essentially No Switching Losses
- Higher Efficiency
- Reduction of Heat Sink Requirements
- Parallel Devices Without Thermal Runaway

### Applications

- Switch Mode Power Supplies
- Power Factor Correction
- Motor Drives

### Package

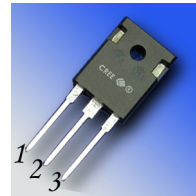

TO-247-3

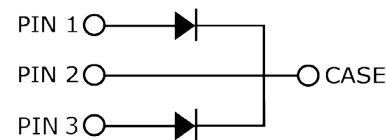

Part Number	Package	Marking
C2D10120D	TO-247-3	C2D10120

### Maximum Ratings

Symbol	Parameter	Value	Unit	Test Conditions	Note
$V_{RRM}$	Repetitive Peak Reverse Voltage	1200	V		
$V_{RSM}$	Surge Peak Reverse Voltage	1200	V		
$V_{DC}$	DC Blocking Voltage	1200	V		
$I_{F(AVG)}$	Average Forward Current (Per Leg/Device)	7/14 10/20	A	$T_C=149^\circ\text{C}$ $T_C=125^\circ\text{C}$	
$I_{F(PEAK)}$	Peak Forward Current (Per Leg/Device)	15/30	A	$T_C=125^\circ\text{C}$ , $T_{REP}<1\text{ ms}$ , Duty=0.5	
$I_{FRM}$	Repetitive Peak Forward Surge Current	30*	A	$T_C=25^\circ\text{C}$ , $t_p=8.3\text{ ms}$ , Half Sine Wave	
$I_{FSM}$	Non-Repetitive Peak Forward Surge Current	100*	A	$T_C=25^\circ\text{C}$ , $t_p=10\text{ }\mu\text{s}$ , Pulse	
$P_{tot}$	Power Dissipation	138* 46*	W	$T_C=25^\circ\text{C}$ $T_C=125^\circ\text{C}$	
$T_J, T_{stg}$	Operating Junction and Storage Temperature	-55 to +175	$^\circ\text{C}$		

\*\* Per Device, \* Per Leg

## Electrical Characteristics (Per Leg)

Symbol	Parameter	Typ.	Max.	Unit	Test Conditions	Note
$V_F$	Forward Voltage	1.6 2.6	1.8 3.0	V	$I_F = 5\text{ A}$ $T_J = 25^\circ\text{C}$ $I_F = 5\text{ A}$ $T_J = 175^\circ\text{C}$	
$I_R$	Reverse Current	50 100	200 1000	$\mu\text{A}$	$V_R = 1200\text{ V}$ $T_J = 25^\circ\text{C}$ $V_R = 1200\text{ V}$ $T_J = 175^\circ\text{C}$	
$Q_C$	Total Capacitive Charge	28		nC	$V_R = 1200\text{ V}$ , $I_F = 5\text{ A}$ $di/dt = 500\text{ A}/\mu\text{s}$ $T_J = 25^\circ\text{C}$	
C	Total Capacitance	455 45 33		pF	$V_R = 0\text{ V}$ , $T_J = 25^\circ\text{C}$ , $f = 1\text{ MHz}$ $V_R = 200\text{ V}$ , $T_J = 25^\circ\text{C}$ , $f = 1\text{ MHz}$ $V_R = 400\text{ V}$ , $T_J = 25^\circ\text{C}$ , $f = 1\text{ MHz}$	

Note:

1. This is a majority carrier diode, so there is no reverse recovery charge.

## Thermal Characteristics

Symbol	Parameter	Typ.	Max.	Unit	Test Conditions	Note
$R_{\theta JC}$	Thermal Resistance from Junction to Case	1.08** 0.54*		$^\circ\text{C}/\text{W}$		

\*\* Per Leg, \* Both Legs

## Typical Performance (Per Leg)

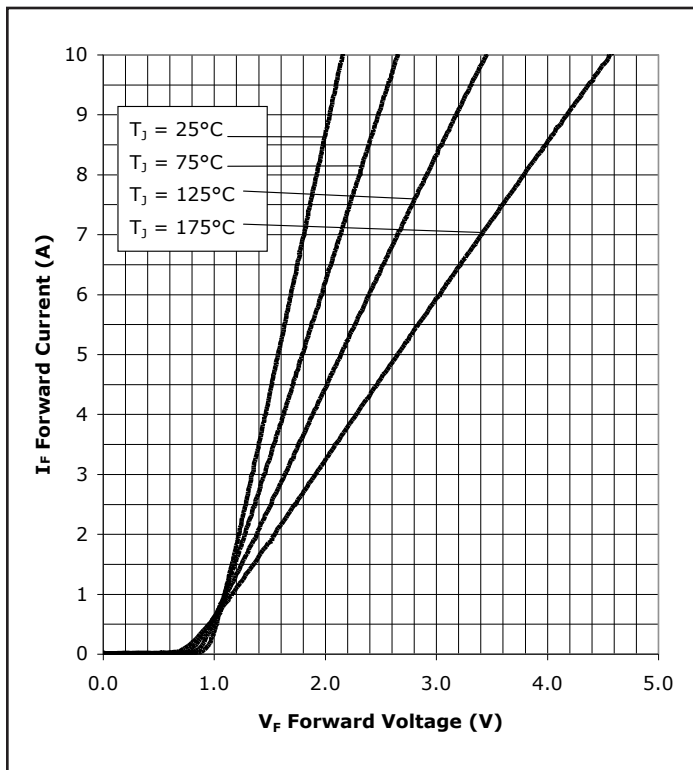

Figure 1. Forward Characteristics

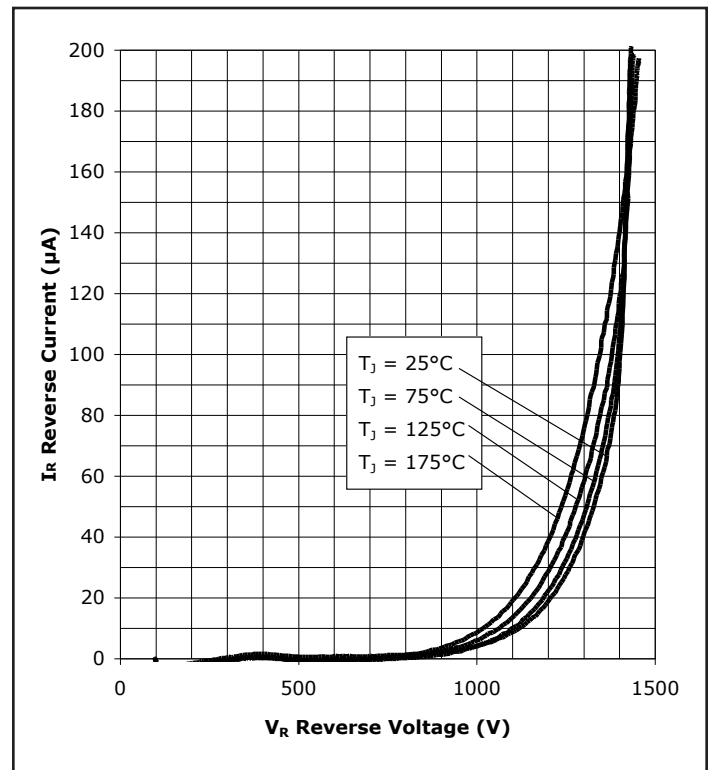

Figure 2. Reverse Characteristics



### Typical Performance (Per Leg)

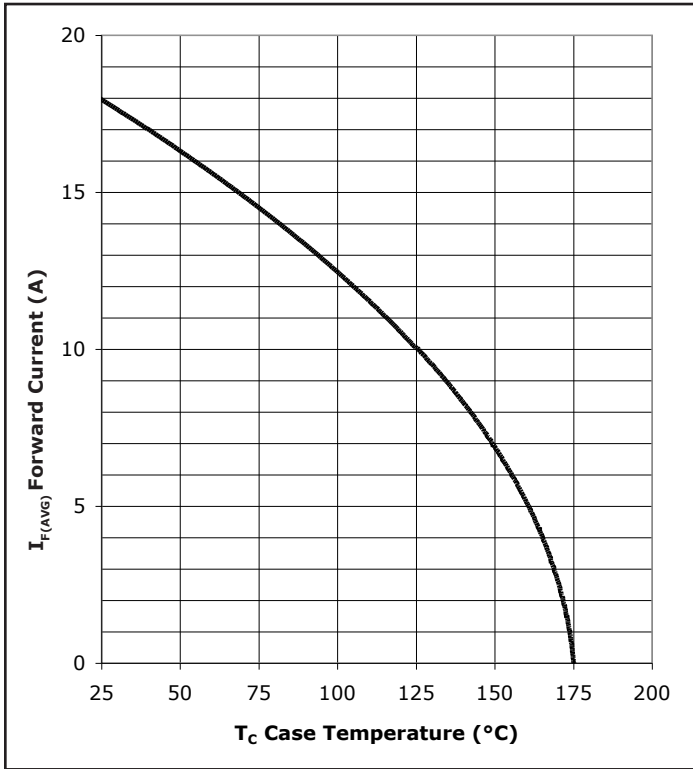

Figure 3. Current Derating

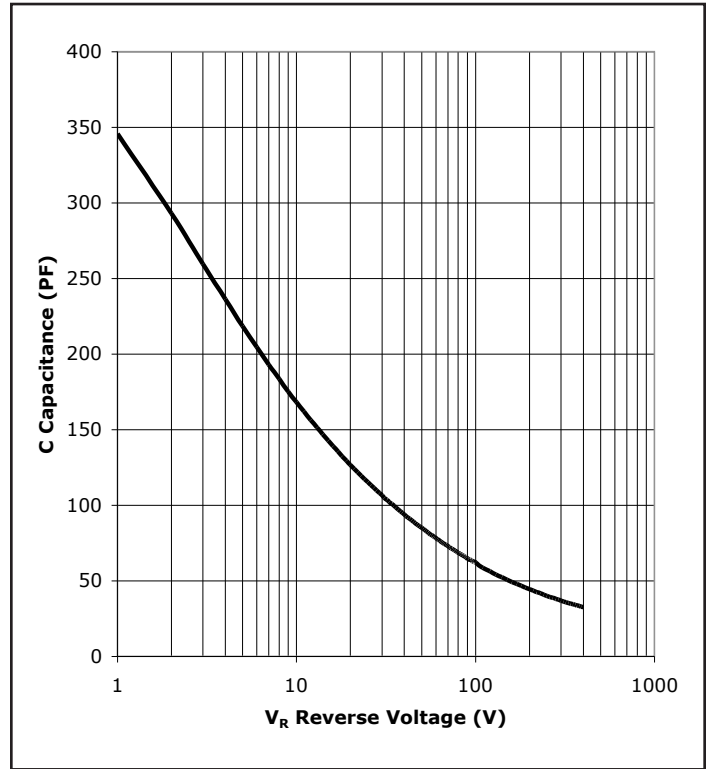

Figure 4. Capacitance vs. Reverse Voltage

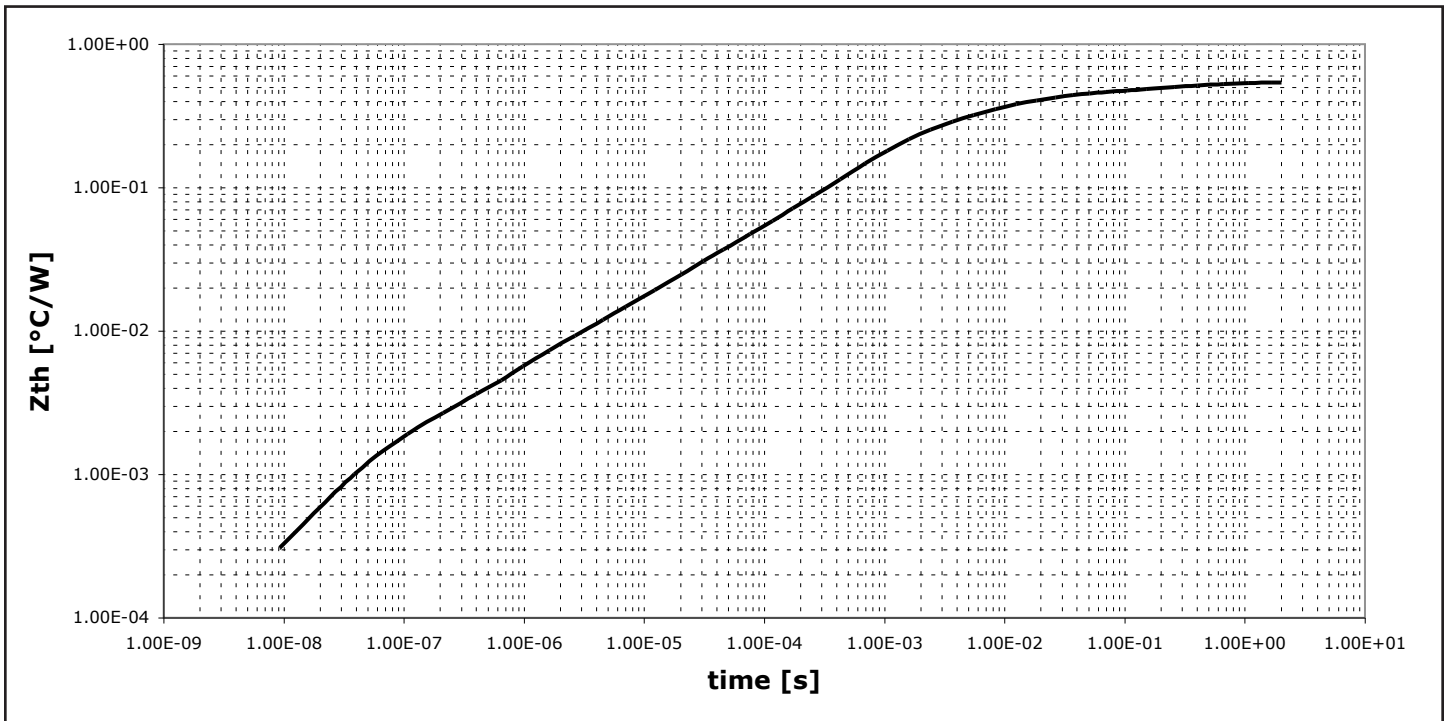
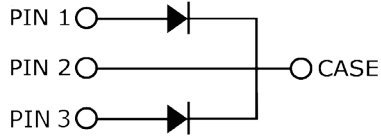
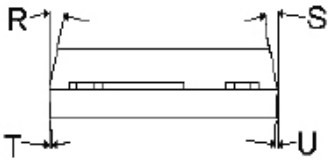
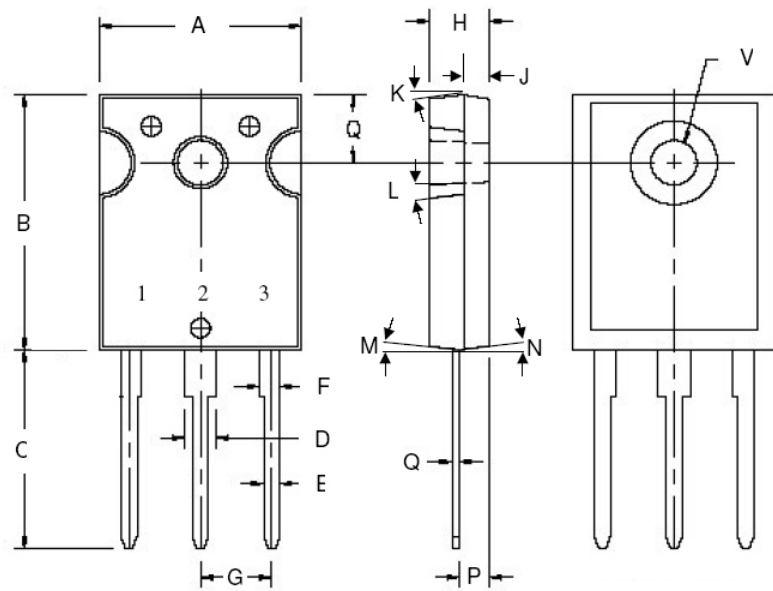

Figure 5. Transient Thermal Impedance

## Package Dimensions

Package TO-247-3



POS	Inches		Millimeters	
	Min	Max	Min	Max
A	.605	.631	15.367	16.027
B	.800	.830	20.320	21.082
C	.620	.799	15.748	20.295
D	.095	.126	2.413	3.200
E	.046	.052	1.168	1.321
F	.060	.084	1.524	2.134
G	.215 TYP		.215 TYP	
H	.180	.203	4.572	5.156
J	.078	.081	1.982	2.057
K	6°	21°	6°	21°
L	4°	6°	4°	6°
M	2°	4°	2°	4°
N	2°	4°	2°	4°
P	.090	.097	2.286	2.464
Q	.020	.030	.508	.762
R	9°	11°	9°	11°
S	9°	11°	9°	11°
T	2°	8°	2°	8°
U	2°	8°	2°	8°
V	.138	.144	3.505	3.658

## Recommended Solder Pad Layout

---

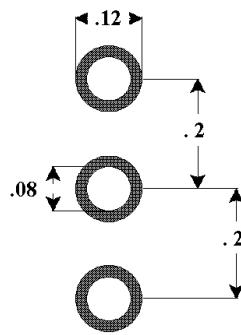

TO-247-3

Part Number	Package	Marking
C2D10120D	TO-247-3	CSD10120

This product has not been designed or tested for use in, and is not intended for use in, applications implanted into the human body nor in applications in which failure of the product could lead to death, personal injury or property damage, including but not limited to equipment used in the operation of nuclear facilities, life-support machines, cardiac defibrillators or similar emergency medical equipment, aircraft navigation or communication or control systems, air traffic control systems, or weapons systems.

Copyright © 2006 Cree, Inc. All rights reserved. The information in this document is subject to change without notice. Cree, the Cree logo, and Zero Recovery are registered trademarks of Cree, Inc.

Cree, Inc.  
 4600 Silicon Drive  
 Durham, NC 27703  
 USA Tel: +1.919.313.5300  
 Fax: +1.919.313.5451  
[www.cree.com/power](http://www.cree.com/power)