

12.5-17GHz Low-Noise Driver Amplifier

GaAs Monolithic Microwave IC

Preliminary

Description

The CHA2266 is a self biased, low-noise high gain driver amplifier. It is designed mainly for VSAT applications in Ku-band. The backside of the chip is both RF and DC grounded. This helps to simplify the assembly process. The circuit is manufactured on a standard GaAs PHEMT process, with via holes through the substrate, air bridges and electron beam gate lithography.

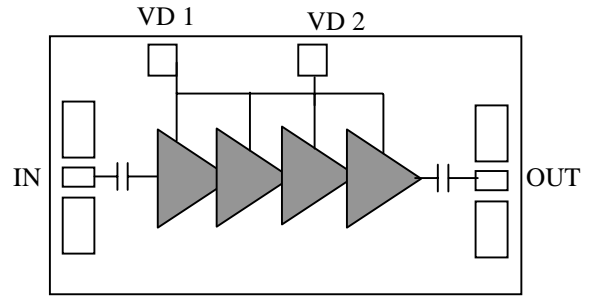

Main Features

- Broad band performance 12.5–17GHz
- 2.5dB noise figure
- 34dB gain, +/- 0.5dB gain flatness
- Low DC power consumption:130mA
- Saturated output power : 16dBm
- Chip size 2.32 x 1.02 x 0.1mm

Typical on wafer measurements

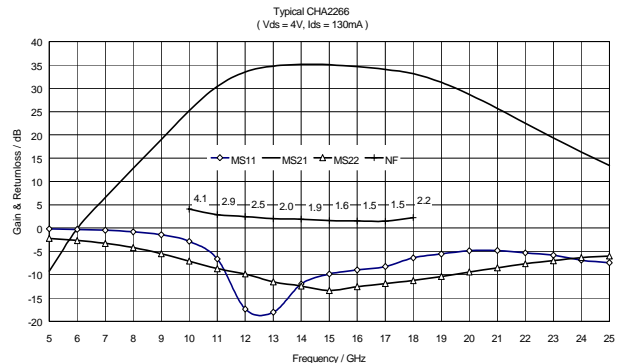

Absolute maximum Ratings (1)

Symbol	Parameter (1)	Values	Unit
Vd	Drain bias voltage	4.3	V
Pin	Maximum continuous input power overdrive	-15	dBm
Top	Operating temperature range	-40 to +85	°C
Tstg	Storage temperature	-55 to +125	°C

(1) Operation of this device above any of these parameters may cause permanent damage.

ESD Protection : Electrostatic discharge sensitive device. Observe handling precautions !

Preliminary

Electrical Characteristics

Tamb = +25°C, Vdd = 4V

Symbol	Parameter	Min	Typ	Max	Unit
Fop	Operating frequency range	12.5		17	GHz
G	Small signal gain		34		dB
ΔG	Small signal gain flatness		± 0.5		dB
NF	Noise Figure		2.5	3.0	dB
RLin	Input return loss		-10		dB
RLout	Output return loss		-10		dB
P1dB	Output power at 1 dB gain compression	14	15		dBm
Pin	Maximum peak input overdrive (1)			15	dBm
Vdd	Drain bias voltage		4		V
Id small signal	Drain bias current		130		mA

(1) Duration < 1s

Typical Results

Typical Chip Response (On wafer S-parameter*)

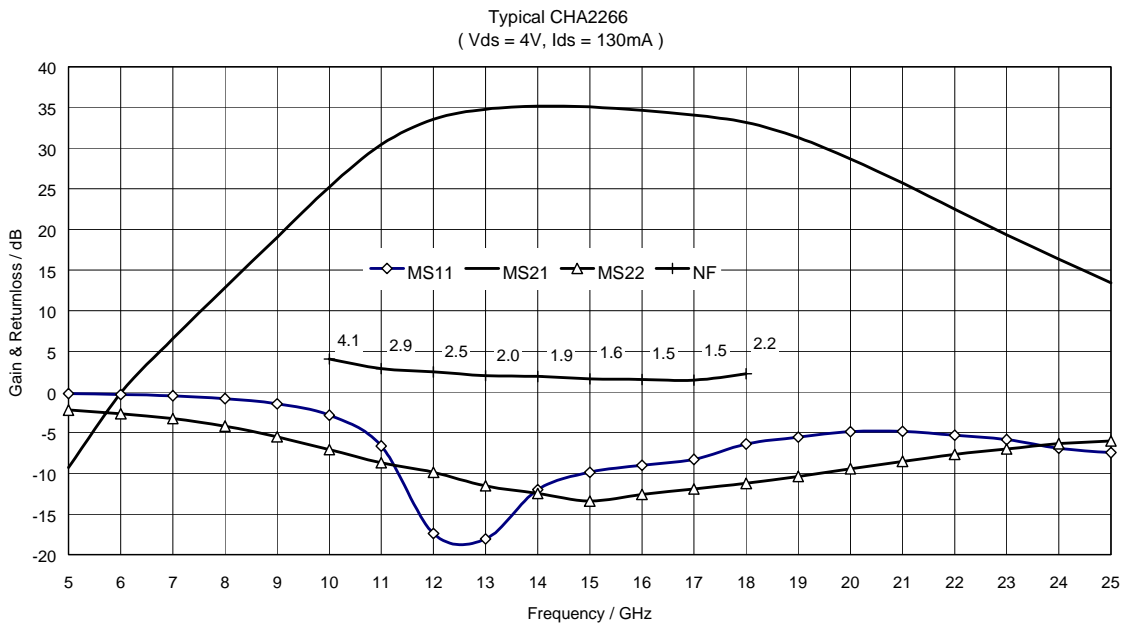

*Return loss improves with bondings.

Typical On Wafer Scattering Parameters:

Tamb = +25°C, Bias Conditions: Vd = 4V, Id = 130mA

Preliminary

Freq/GHz	MS11	PS11	MS12	PS12	MS21	PS21	MS22	PS22	NF
5.00	-0.19	-60.43	-80.46	-28.08	-9.27	55.33	-2.21	-70.44	
6.00	-0.30	-74.26	-78.78	-70.24	-0.12	-24.96	-2.68	-82.41	
7.00	-0.46	-89.33	-75.88	2.69	6.56	-88.05	-3.27	-95.03	
8.00	-0.80	-106.32	-72.20	32.17	12.83	-142.23	-4.19	-107.99	
9.00	-1.44	-125.75	-73.72	-51.84	19.02	165.74	-5.51	-118.06	
10.00	-2.86	-151.22	-66.33	-115.35	25.20	108.42	-7.08	-126.35	4.06
11.00	-6.63	177.56	-70.35	-76.43	30.42	42.05	-8.70	-131.49	2.88
12.00	-17.39	153.85	-66.55	-128.54	33.53	-28.39	-9.87	-134.03	2.46
13.00	-18.06	-84.40	-65.32	168.52	34.77	-94.85	-11.53	-135.84	2.01
14.00	-12.00	-98.21	-59.86	-136.83	35.15	-154.68	-12.46	-131.75	1.92
15.00	-9.86	-113.78	-76.73	168.29	35.05	149.44	-13.41	-127.10	1.60
16.00	-9.01	-121.29	-56.32	80.85	34.64	97.72	-12.58	-114.59	1.55
17.00	-8.27	-129.83	-57.21	-170.04	34.05	46.71	-11.91	-113.66	1.46
18.00	-6.40	-139.02	-62.54	-89.64	33.15	-4.88	-11.24	-113.55	2.24
19.00	-5.55	-156.24	-65.06	53.72	31.28	-55.40	-10.37	-116.41	
20.00	-4.88	-174.36	-67.73	-90.69	28.65	-101.56	-9.43	-117.46	
21.00	-4.83	166.53	-55.41	154.09	25.68	-143.31	-8.53	-120.11	
22.00	-5.31	149.22	-53.79	91.59	22.47	-179.42	-7.66	-125.61	
23.00	-5.85	132.80	-52.72	-168.14	19.33	148.56	-7.00	-131.61	
24.00	-6.91	118.54	-50.50	80.81	16.33	119.70	-6.35	-137.67	
25.00	-7.45	103.68	-71.86	-7.37	13.42	93.05	-6.02	-145.44	

Preliminary

Typical Test-Jig Results

S- Parameters @ small signal

Tamb 25 °C, Vd = 4V, Id = 130mA

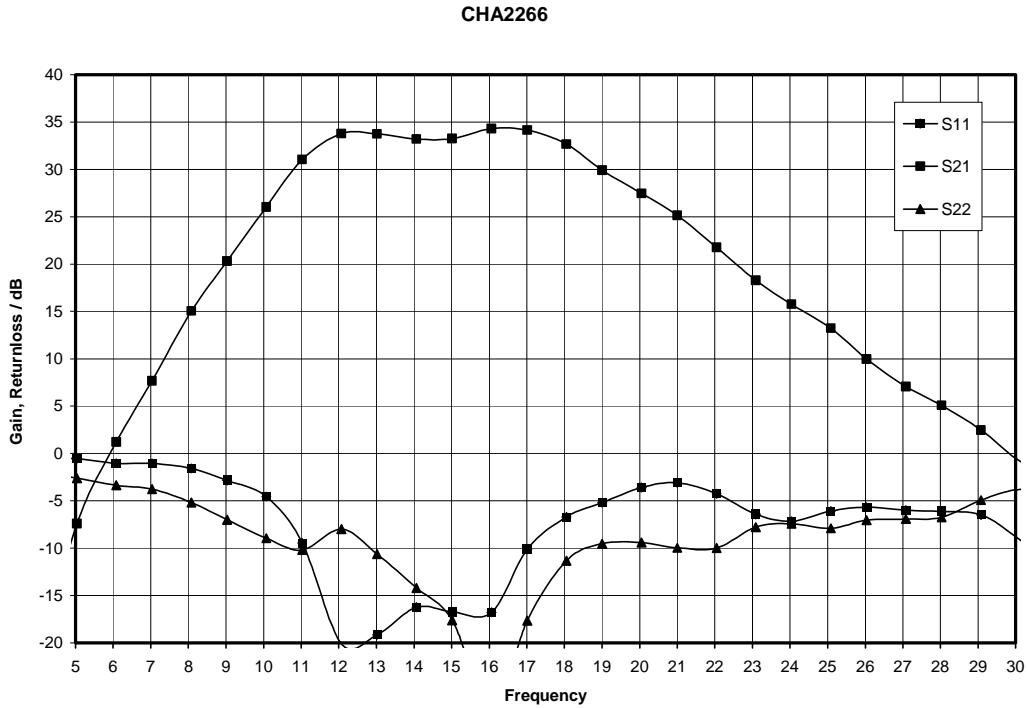

Pin vs. Pout for 14, 15 and 16GHz

Tamb = 25°C, Vd = 4 V, IDmax 170mA

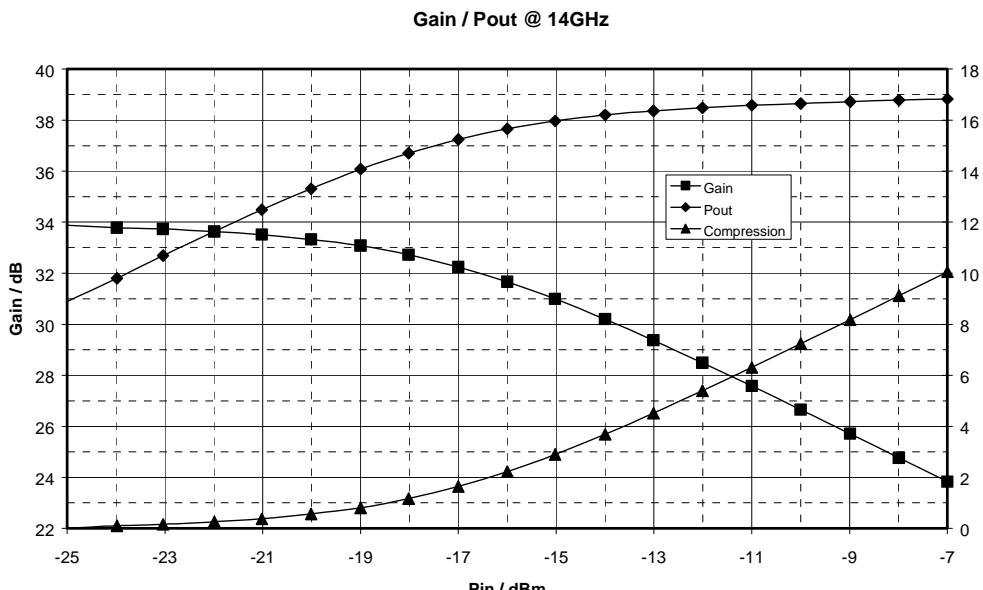

Preliminary

Gain / Pout @ 15GHz

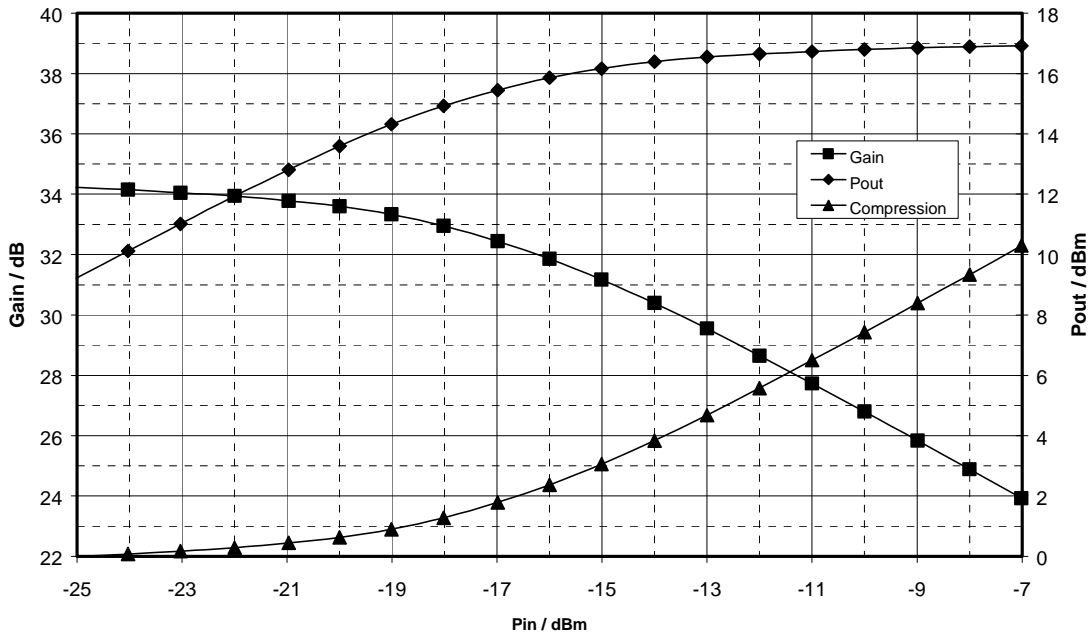

Gain / Pout @ 16GHz

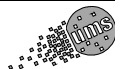
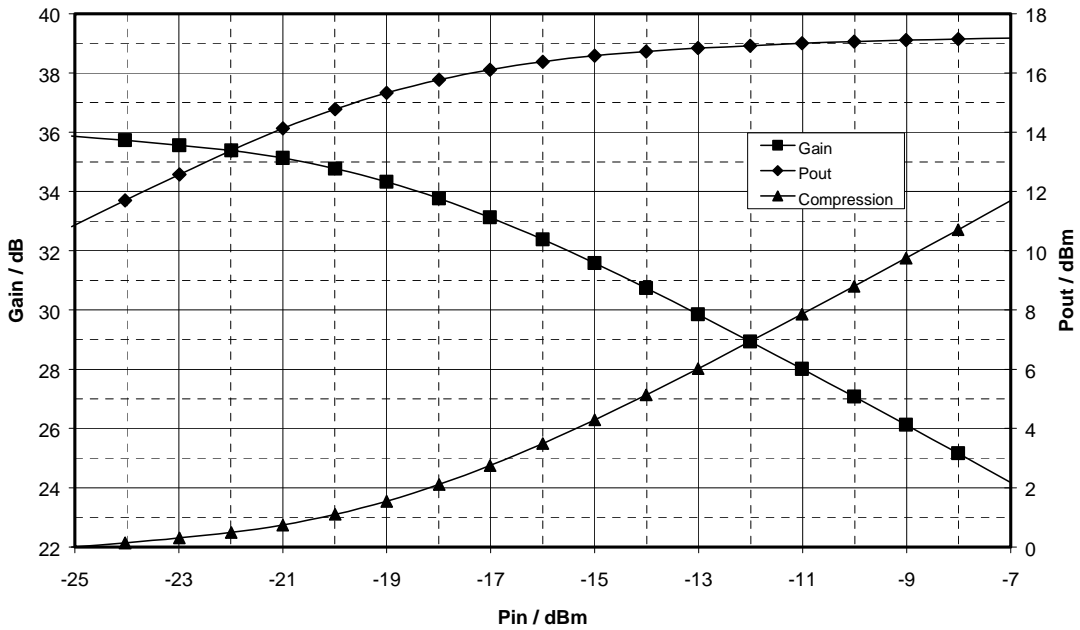

Chip Assembly and Mechanical Data

Preliminary

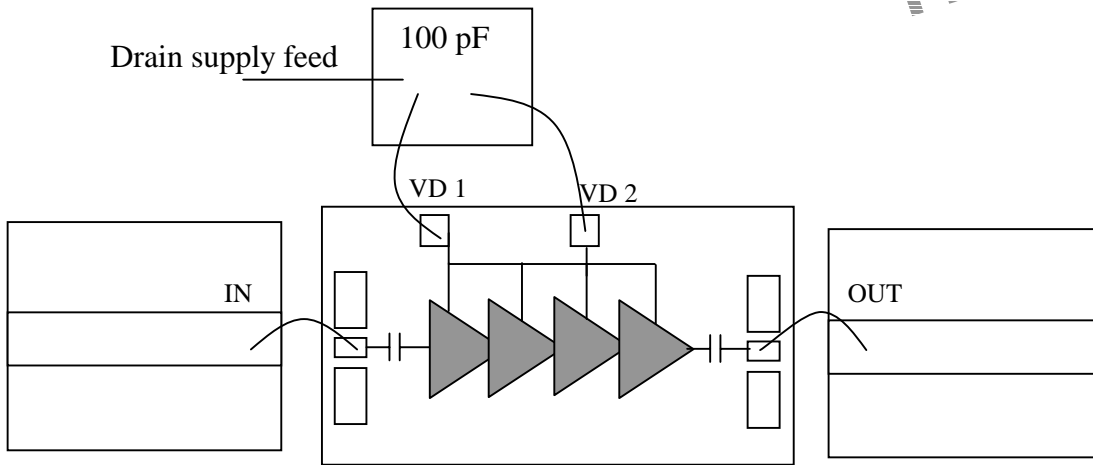

Note: Supply feed should be bypassed. 25µm diameter gold wire is recommended

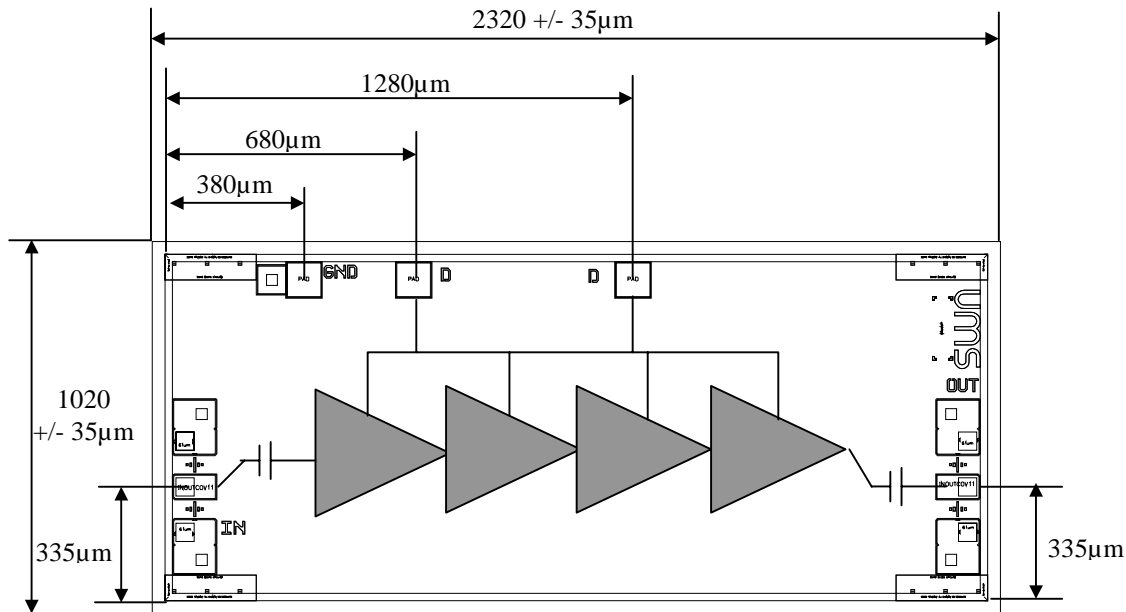

Bond pad positions

(Chip thickness : 100 µm. all dimensions are in micrometers)

Preliminary

Ordering Information: CHA2266-99F/00

Information furnished is believed to be accurate and reliable. However **United Monolithic Semiconductors S.A.S.** assumes no responsibility for the consequences of use of such information nor for any infringement of patents or other rights of third parties which may result from its use. No license is granted by implication or otherwise under any patent or patent rights of **United Monolithic Semiconductors S.A.S.** Specifications mentioned in this publication are subject to change without notice. This publication supersedes and replaces all information previously supplied. **United Monolithic Semiconductors S.A.S.** products are not authorised for use as critical components in life support devices or systems without express written approval from **United Monolithic Semiconductors S.A.S.**

