



## WBFBP-06C Plastic-Encapsulate Diode

### FBAS70TW

SURFACE MOUNT SCHOTTKY BARRIER DIODE ARRAYS

#### DESCRIPTION

Silicon epitaxial planar  
PN Junction Guard Ring for Schottky Diode

#### FEATURES

- Low Forward Voltage Drop
- Fast Switching
- Ultra-Small Surface Mount Package

#### APPLICATION

For General Purpose Switching Applications, rectifiers  
For portable equipment:(i.e. Mobile phone,MP3, MD,CD-ROM,  
DVD-ROM, Note book PC, etc.)

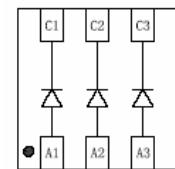
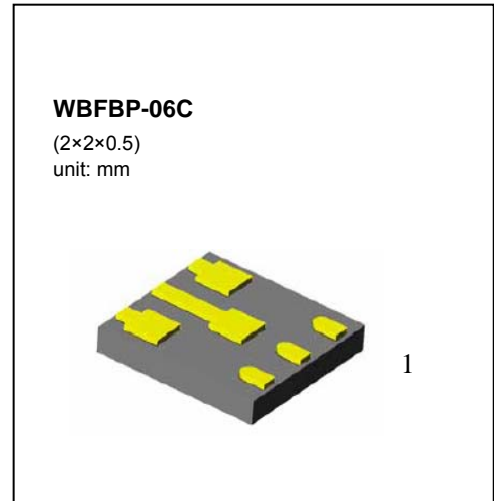

**FBAS70TW**

**Marking:K73**

#### Maximum Ratings @ $T_A=25$

Parameter	Symbol	Limits	Unit
Peak Repetitive Peak reverse voltage	$V_{RRM}$	70	V
Working Peak Reverse Voltage	$V_{RWM}$		
DC Blocking Voltage	$V_R$		
Forward Continuous Current	$I_F$	70	mA
Peak forward surge current @<1.0s	$I_{FSM}$	100	mA
Power Dissipation	$P_d$	150	mW
Thermal Resistance Junction to Ambient	$R_{\theta JA}$	625	$^{\circ}C/W$
Junction temperature	$T_J$	125	$^{\circ}C$
Storage temperature range	$T_{STG}$	-55 to +125	$^{\circ}C$

#### Electrical Ratings @ $T_A=25^{\circ}C$

Parameter	Symbol	Min.	Typ.	Max.	Unit	Conditions
Forward voltage	$V_{F1}$			0.41	V	$I_F=1mA$
	$V_{F2}$			1	V	$I_F=15mA$
Reverse current	$I_R$			100	nA	$V_R=50V$
Capacitance between terminals	$C_T$			2	pF	$V_R=0V, f=1MHz$
Reverse Recovery Time	$t_{rr}$			5	ns	$I_F=I_R=10mA$ $I_{rr}=0.1I_R, R_L=100\Omega$

# Typical Characteristics

# FBAS70TW

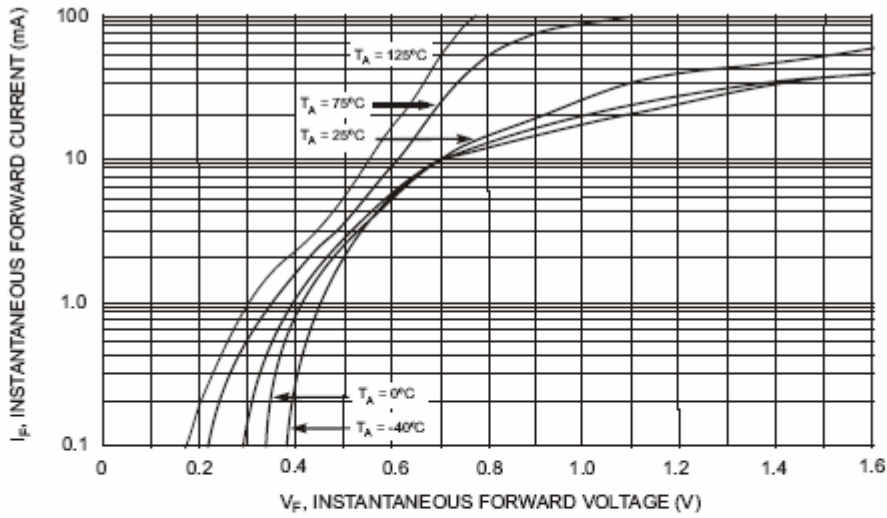

Fig. 1 Typical Forward Characteristics

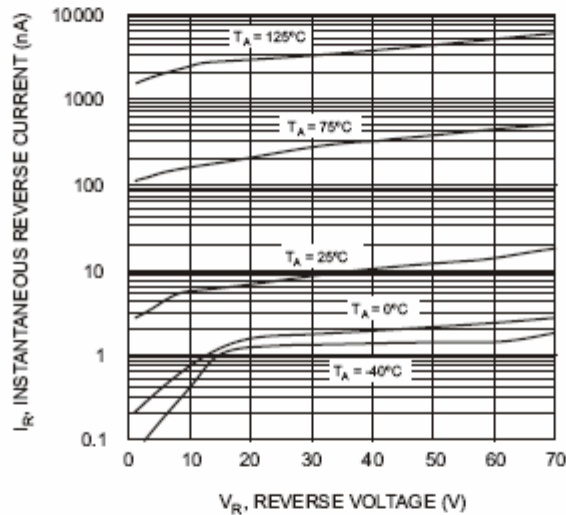

Fig. 2 Typical Reverse Characteristics

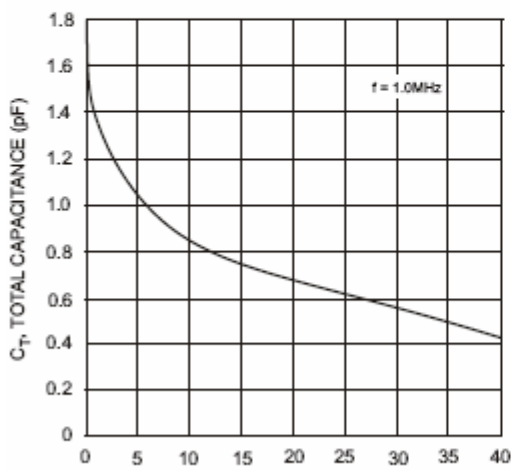

Fig. 3 Typical Capacitance

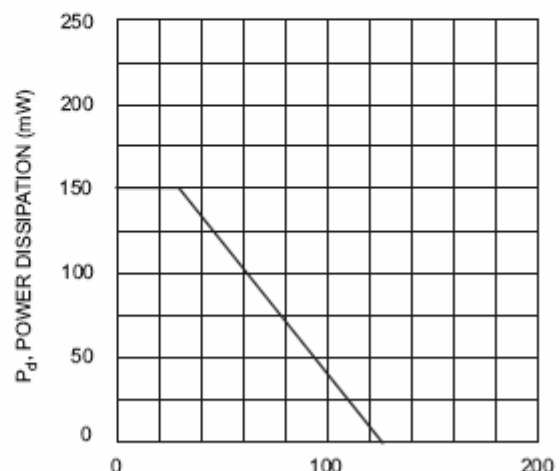
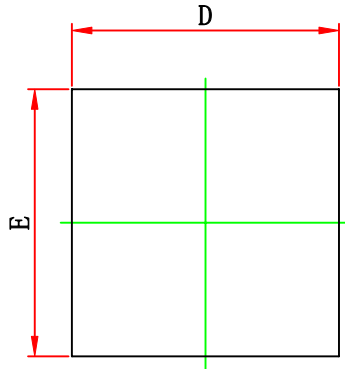

Fig. 4 Power Derating Curve, Total Package



### WBFBP-06C(2×2×0.5) PACKAGE OUTLINE DIMENSIONS



TOP VIEW

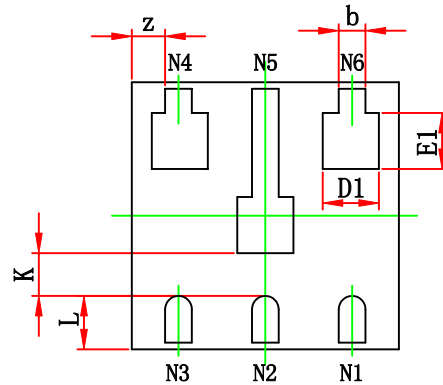

BOTTOM VIEW

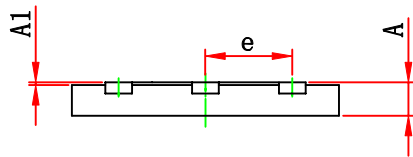

SIDE VIEW

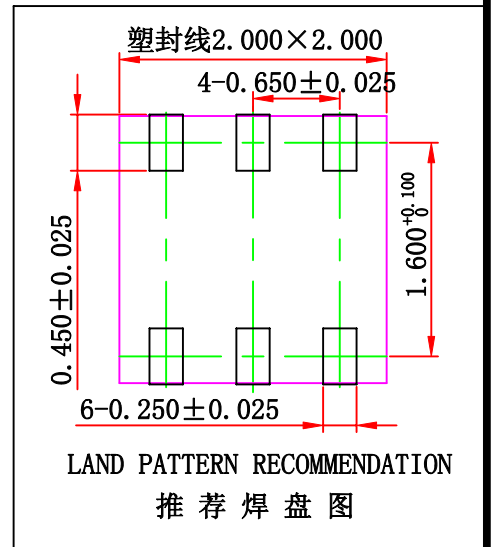

Symbol	Dimensions In Millimeters		Dimensions In Inches	
	Min.	Max.	Min.	Max.
A	0.450	0.550	0.018	0.022
A1	0.000	0.100	0.000	0.004
b	0.150	0.250	0.006	0.010
D	1.900	2.100	0.075	0.083
E	1.900	2.100	0.075	0.083
D1	0.420 REF.		0.017 REF.	
E1	0.420 REF.		0.017 REF.	
e	0.650 TYP.		0.026 TYP.	
L	0.400 REF.		0.016 REF.	
k	0.300 REF.		0.012 REF.	
z	0.500 REF.		0.020 REF.	

## APPLICATION CIRCUITS

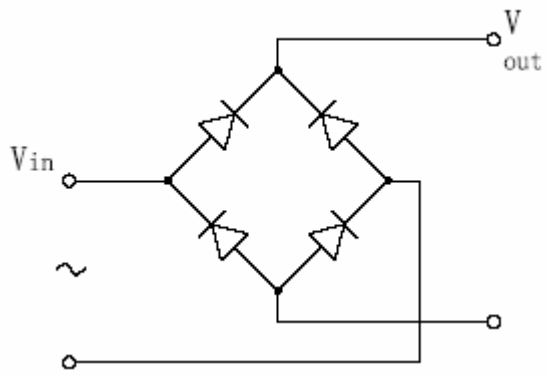

Bridge rectifiers