



## WBFBP-06C Plastic-Encapsulate Diodes

### FBAT54ADW

SURFACE MOUNT SCHOTTKY BARRIER DIODE ARRAYS

#### DESCRIPTION

Silicon epitaxial planar  
PN Junction Guard Ring for Schottky Diode

#### FEATURES

- Low Forward Voltage Drop
- Fast Switching

#### APPLICATION

Ultra high speed switching, rectifiers  
For portable equipment:(i.e. Mobile phone,MP3, MD,CD-ROM,  
DVD-ROM, Note book PC, etc.)

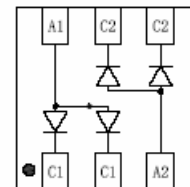
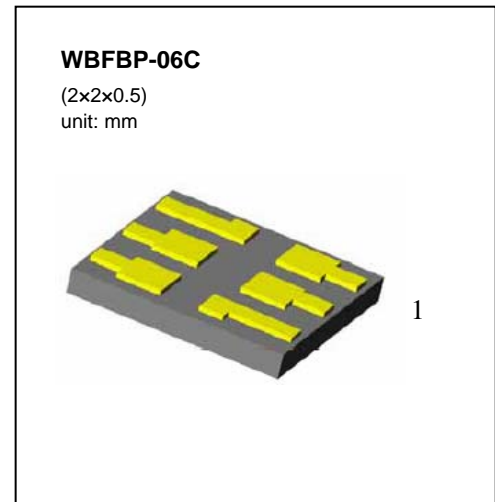

FBAT54ADW  
Marking:KL6

#### Maximum Ratings @T<sub>A</sub>=25°C

Parameter	Symbol	Limits	Unit
Peak Repetitive reverse voltage DC Blocking Voltage	V <sub>RM</sub> V <sub>R</sub>	30	V
Average Rectified Output Current	I <sub>O</sub>	100	mA
Power Dissipation	P <sub>D</sub>	150	mW
Junction temperature	T <sub>J</sub>	125	°C
Storage temperature range	T <sub>STG</sub>	-65-125	°C

#### ELECTRICAL CHARACTERISTICS (T<sub>amb</sub>=25°C unless otherwise specified)

Parameter	Symbol	Test conditions	MIN	MAX	UNIT
Reverse breakdown voltage	V <sub>(BR)</sub>	I <sub>R</sub> = 100 μ A	30		V
Reverse voltage leakage current	I <sub>R</sub>	V <sub>R</sub> =25V		2	uA
Forward voltage	V <sub>F</sub>	I <sub>F</sub> =0.1mA		240	mV
		I <sub>F</sub> =1mA		320	
		I <sub>F</sub> =10mA		400	
		I <sub>F</sub> =30mA		500	
		I <sub>F</sub> =100mA		1000	
Total capacitance	C <sub>T</sub>	V <sub>R</sub> =1V,f=1MHz		10	pF
Reverse recovery time	t <sub>rr</sub>	I <sub>F</sub> =10mA, I <sub>R</sub> =10mA~1mA R <sub>L</sub> =100Ω		5	nS

# Typical Characteristics

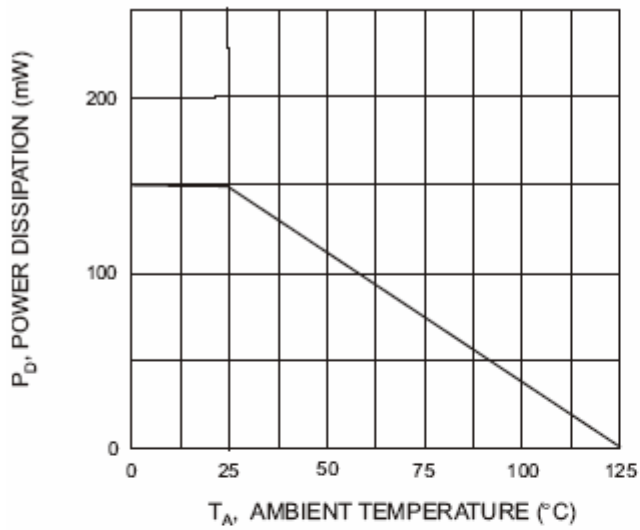

Fig. 1 Power Derating Curve

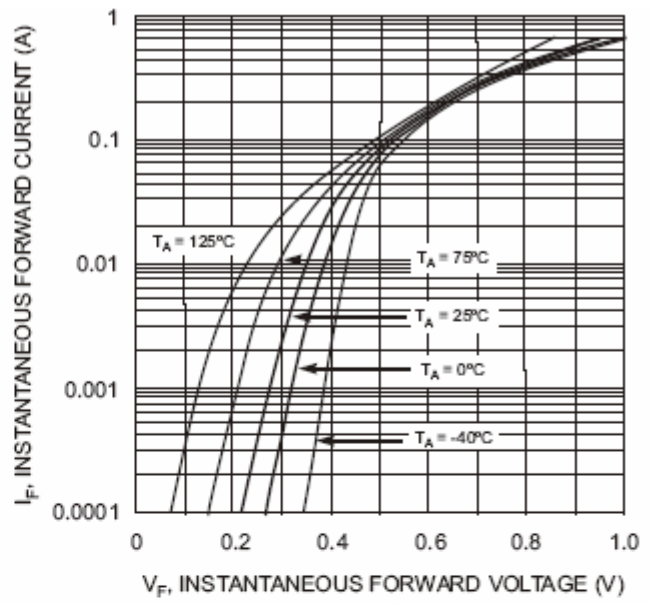

Fig. 2 Forward Characteristics

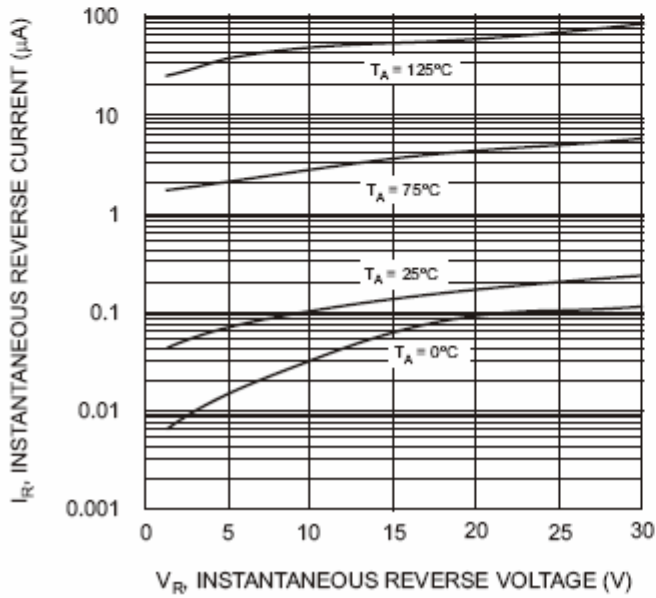

Fig. 3 Typical Reverse Characteristics

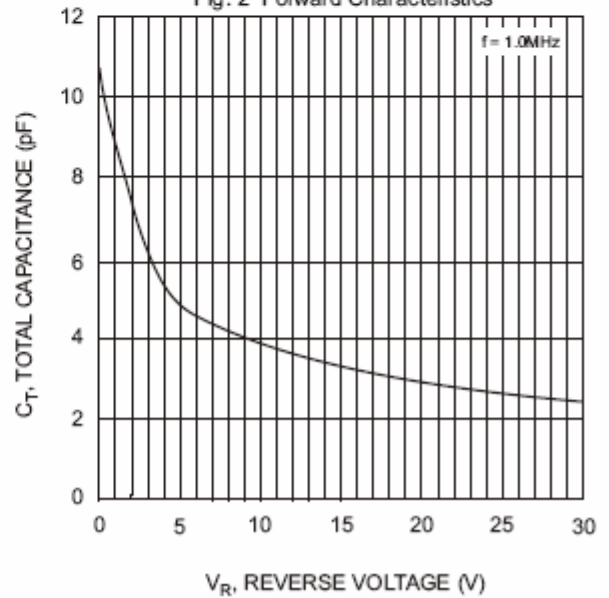
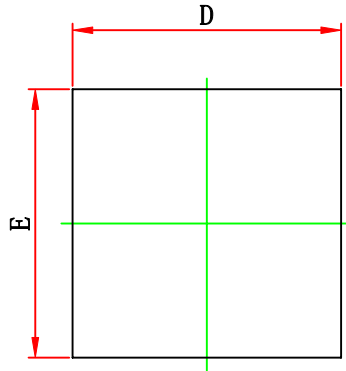

Fig. 4 Typical Capacitance vs. Reverse Voltage



**WBFBP-06C(2×2×0.5) PACKAGE OUTLINE DIMENSIONS**



TOP VIEW

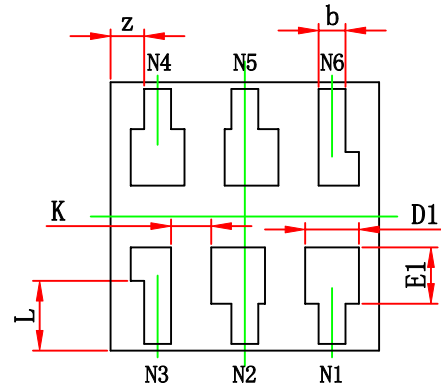

BOTTOM VIEW

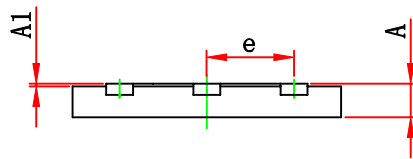

SIDE VIEW

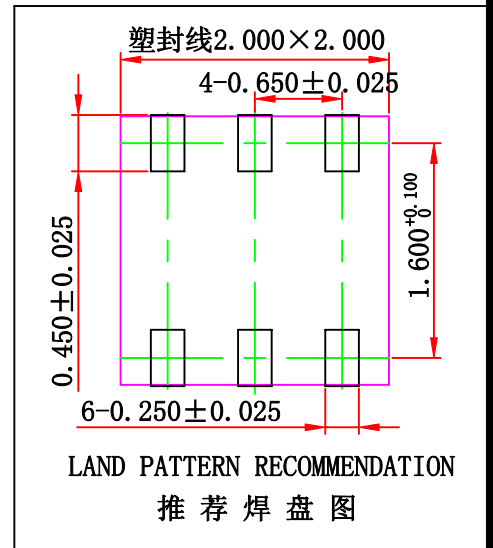

Symbol	Dimensions In Millimeters		Dimensions In Inches	
	Min.	Max.	Min.	Max.
A	0.450	0.550	0.018	0.022
A1	0.000	0.100	0.000	0.004
b	0.150	0.250	0.006	0.010
D	1.900	2.100	0.075	0.083
E	1.900	2.100	0.075	0.083
D1	0.420 REF.		0.017 REF.	
E1	0.420 REF.		0.017 REF.	
e	0.650 TYP.		0.026 TYP.	
L	0.500 REF.		0.020 REF.	
k	0.300 REF.		0.012 REF.	
z	0.500 REF.		0.020 REF.	

## APPLICATION CIRCUITS

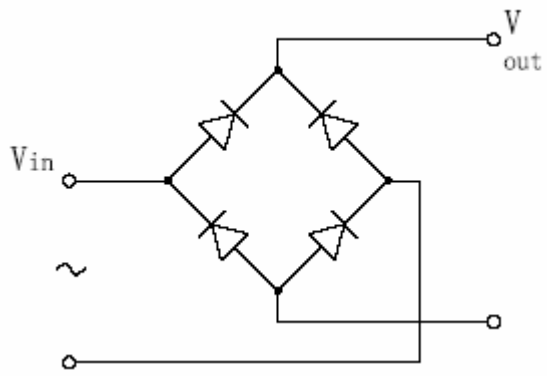

Bridge rectifiers