

World's smallest & lightest

0.5mm pitch, 0.9mm above the board, Flexible Printed Circuit & Flexible Flat Cable Connectors

FH19 & FH19S Series

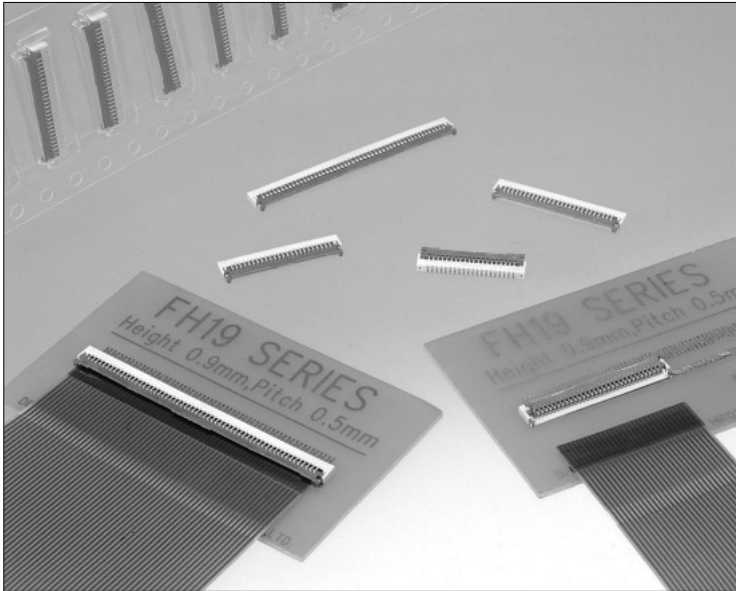

FH19 Series – FPC, FFC thickness: $0.2\pm 0.03\text{mm}$

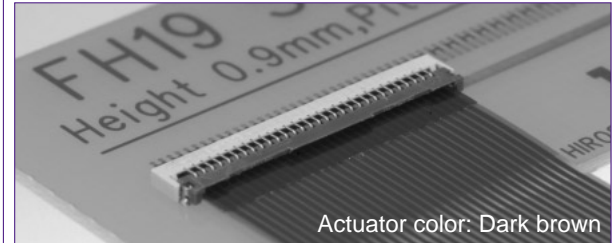

Actuator color: Dark brown

FH19S Series – FPC, FFC thickness: $0.3\pm 0.03\text{mm}$



Actuator color: Black

Features

World's smallest & lightest

1. Low-profile 0.5mm pitch FPC, FFC Connectors

Miniaturization of portable equipment and personal mobile devices has created increased demand for a low profile, high density, and high reliability connectors.

*The design of this connector has been made thinner and smaller, with a height of 0.9mm and width of 3mm.

[As of August 2002, this is the smallest connector of this type available on the market !]

*PCB footprint: Reduced approximately 48% (as compared with Hirose Electric's 0.5mm pitch FH12 Series connectors)

*Connector weight: Reduced approximately 78% (as compared with Hirose Electric's 0.5mm pitch FH12 Series connectors)

2. Conductive traces on the PCB can be designed to run under the connector

All bottom surface of the connector is solid, without any exposure of the contact.

3. Proven Flip-Lock Actuator System assures easy and reliable operation

Rotating actuator permits easy insertion and reliable connection with the FPC & FFC.

Tactile sensation confirms complete mechanical locking of the actuator and the electrical connection.

4. Accepts 0.2mm & 0.3mm thick FPC, FFC

Accepts 0.2mm & 0.3mm thick FPC, FFC, easy inserted in the connector.

The connector will also terminate successfully with 0.2mm thick Flat Flexible Cable (FFC).

5. Designed for placement with automatic equipment

Packaged in embossed tape, on reel.

One reel contains 5,000 pieces.

6. Environmental considerations

The center cores of the embossed tape reels are made of paper, unlike typical cores made of styrofoam.

● 0.9mm Height incorporates the Flip-Lock System (30pos. Type)

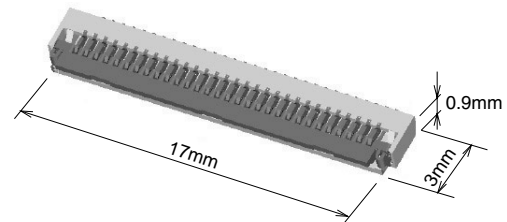

● Enclosed construction

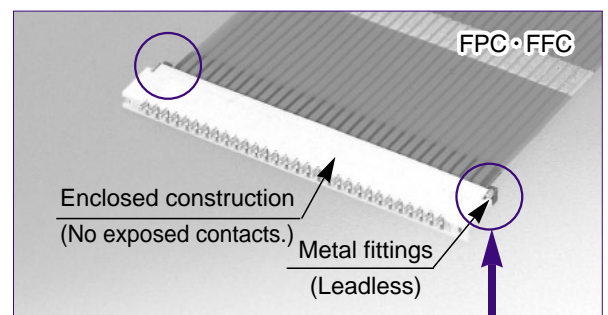

● Metal Fittings (Leadless Type)

Absence of protrusions from the connector helps in design of miniaturized devices.



Applications

Notebook PC's, PDA's, digital cameras and other compact devices requiring interconnections of the main circuit board with the LCD, plasma display (PDP), HDD or other devices.

Product Specifications

Rating	Current rating 0.5 A DC	Operating temperature range -55°C to +80°C (Note 1)	Storage temperature range -10°C to +50°C (Note 2)
	Voltage rating 50 V AC	Operating humidity range Relative humidity 90% max. (No condensation)	Storage humidity range Relative humidity 90% max.

Recommended FPC, FFC	FH19 Series	Thickness: = 0.2 ± 0.03mm Tin-lead plating (Note 3)
	FH19S Series	Thickness: = 0.3 ± 0.03mm Tin-lead plating (Note 3)

Item	Specification	Conditions
1. Insulation resistance	500 M ohms min.	100 V DC
2. Withstanding voltage	No flashover or insulation breakdown	150 V AC/1 minute
3. Contact resistance	100 m ohms max. *Including FPC/FFC conductor resistance	1 mA
4. Durability (insertion/ withdrawal)	Contact resistance: 100 m ohms max. No damage, cracks, or parts dislocation.	20 cycles
5. Vibration	No electrical discontinuity of 1 μs or more. Contact resistance: 100 m ohms max. No damage, cracks, or parts dislocation.	Frequency: 10 to 55 Hz, single amplitude of 0.75mm, 2 hours in each of the 3 directions
6. Shock	No electrical discontinuity of 1 μs. min. Contact resistance: 100 m ohms max. No damage, cracks, or parts dislocation.	Acceleration of 981 m/s ² , 6 ms duration, sine half-wave waveform, 3 cycles in each of the 3 axis.
7. Humidity (Steady state)	Contact resistance: 100 m ohms max. Insulation resistance: 100 M ohms min. No damage, cracks, or parts dislocation.	96 hours at temperature of 40°C and humidity of 90 to 95%
8. Temperature cycle	Contact resistance: 100 m ohms max. Insulation resistance: 100 M ohms min. No damage, cracks, or parts dislocation.	Temperature: -40°C → +15°C to +35°C → +85°C → +15°C to +35°C Time: 30 → 2 to 3 → 30 → 2 to 3 (Minutes) 5 cycles
9. Resistance to soldering heat	No deformation of components affecting performance.	Reflow: At the recommended temperature profile Manual soldering: 350°C±5°C for 5 seconds

Note 1: Includes temperature rise caused by current flow.

Note 2: The term "storage" refers to products stored for long period of time prior to mounting and use. Operating Temperature Range and Humidity range covers non- conducting condition of installed connectors in storage, shipment or during transportation.

Note 3: When FPC is gold plated, the connector contacts should be also gold plated: Select the (05) specification.

Materials

Part	Material	Finish	Remarks
Insulator	LCP	Color: Beige	UL94V-0
	PPS	Color: Dark brown (FH19 Series) Color: Black (FH19S Series)	
Contacts	Phosphor bronze	Tin-lead plating (Note 3)	—
Metal fittings	Phosphor bronze	Pure tin reflow plating	—

Ordering information

FH19 **S** - **30S** - **0.5** **SH** **(05)**
1 2 3 4 5 6

1 Series name :	FH19	4 Contact pitch :	0.5mm
2 Blank :	FPC,FFC thickness : 0.2mm	5 Terminal type	SH: SMT horizontal mounting type
S :	FPC,FFC thickness : 0.3mm	6 Plating specifications :	(05): Gold plating (51): Tin-lead plating
3 No. of contacts :	4 to 50		

◆ Connector Operating Instructions, Precautions and Recommendations

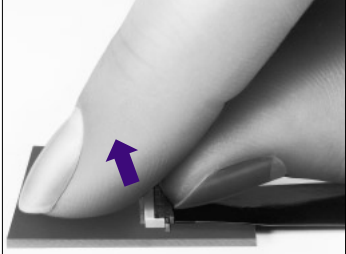
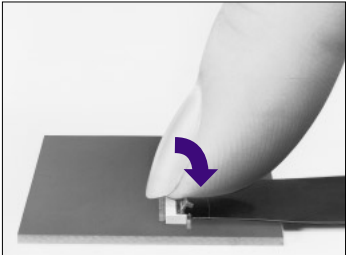
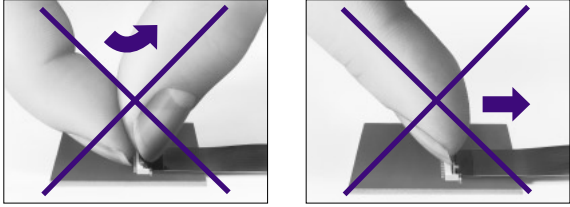
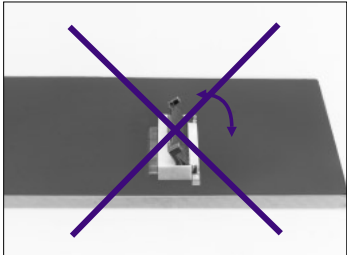
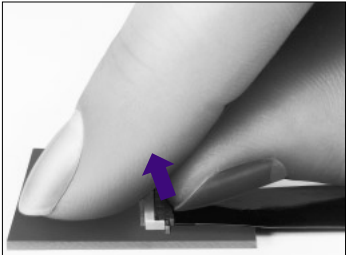
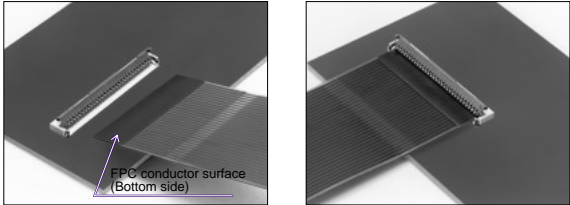
Operation	Precautions
<p>1. FPC/FFC Termination procedure. Connector installed on the board.</p> <p>1) Lift up the actuator. Use thumb or index finger.</p>  <p>2) Rotate down the actuator until firmly closed. It is critical that the inserted FPC/FFC is not moved and remains fully inserted. Should the FPC/FFC be moved, open the actuator and repeat the process, starting with Step 1 above.</p> 	<p>1) Do not apply excessive force or use any type of tool to operate the actuator.</p>  <p>2) The connector will assure reliable performance when the actuator is open to 130° maximum (see fig.1) Do not exceed this angle, as this may cause permanent damage to the connector.</p> 
<p>2. FPC/FFC Removal</p> <p>1) Lift up the actuator.</p> <p>2) Carefully remove the FPC/FFC.</p> 	<p>3) Assure that the FPC/FFC is fully inserted parallel to mounting surface, with the exposed conductive traces facing down.</p> 

Connector Dimension

[FH19 Series]

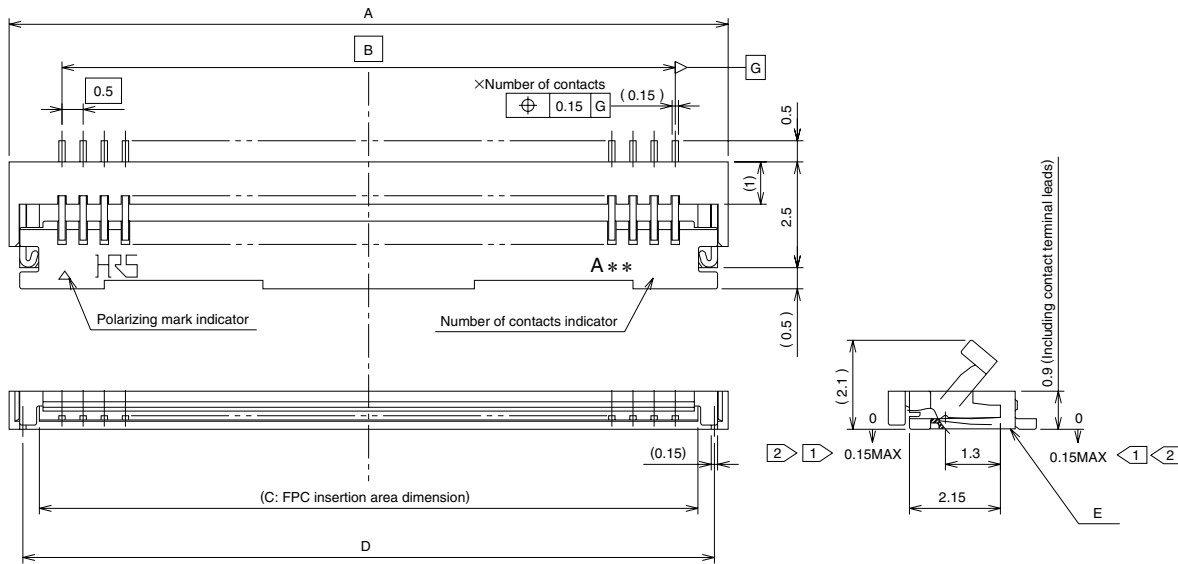

- Notes
- ① The coplanarity of each terminal lead and metal fitting is within 0.1
 - ② The contact terminal lead position indicates the dimension from the E surface, the bottom surface of the insulator body.
 - 3 The connector is supplied in embossed tape packaging. For details see the Packaging Specifications.
 - 4 Any discoloration of the plastic compound will NOT AFFECT form, fit or function of the connector.

Unit: mm

Part Number	CL No.	Number of Contacts	A	B	C	D
FH19-4S-0.5SH(51)	586-1009-8-51	4	4.0	1.5	2.57	3.35
FH19-6S-0.5SH(51)	Reserved for product expansion	6	5.0	2.5	3.57	4.35
FH19-8S-0.5SH(51)	586-1012-2-51	8	6.0	3.5	4.57	5.35
FH19-9S-0.5SH(51)	586-1006-0-51	9	6.5	4.0	5.07	5.85
FH19-13S-0.5SH(51)	586-1001-6-51	13	8.5	6.0	7.07	7.85
FH19-15S-0.5SH(51)	586-1004-4-51	15	9.5	7.0	8.07	8.85
FH19-17S-0.5SH(51)	586-1007-2-51	17	10.5	8.0	9.07	9.85
FH19-20S-0.5SH(51)	586-1002-9-51	20	12.0	9.5	10.57	11.35
FH19-21S-0.5SH(51)	586-1015-0-51	21	12.5	10.0	11.07	11.85
FH19-24S-0.5SH(51)	586-1011-0-51	24	14.0	11.5	12.57	13.35
FH19-27S-0.5SH(51)	586-1000-3-51	27	15.5	13.0	14.07	14.85
FH19-30S-0.5SH(51)	586-1003-1-51	30	17.0	14.5	15.57	16.35
FH19-40S-0.5SH(51)	586-1008-5-51	40	22.0	19.5	20.57	21.35
FH19-50S-0.5SH(51)	586-1005-7-51	50	27.0	24.5	25.57	26.35

Note: Embossed tape reel packaging (5,000 pieces/reel) .
Order by number of reels.

[FH19S Series]

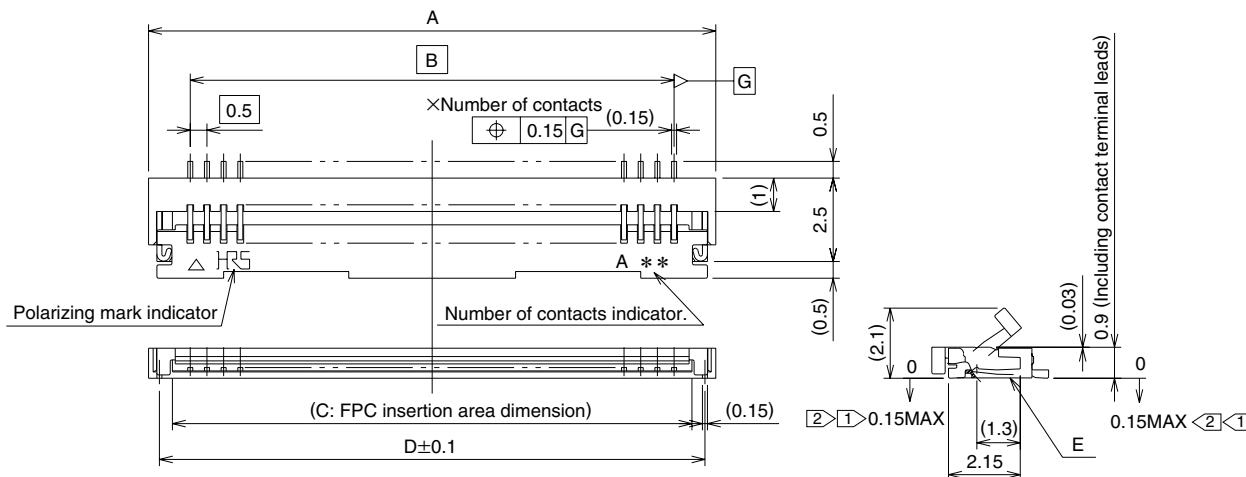

- Notes
- ① The coplanarity of each terminal lead and metal fitting is within 0.1
 - ② The contact terminal lead position indicates the dimension from the E surface, the bottom surface of the insulator body.
 - ③ The connector is supplied in embossed tape packaging. For details see the Packaging Specifications.
 - ④ Any discoloration of the plastic compound will NOT AFFECT form, fit or function of the connector.

Unit: mm

Part Number	CL No.	Number of Contacts	A	B	C	D
FH19S-4S-0.5SH(51)	586-1119-6-51	4	4.0	1.5	2.57	3.35
FH19S-5S-0.5SH(51)	586-1115-5-51	5	4.5	2.0	3.07	3.85
FH19S-6S-0.5SH(51)	Reserved for product expansion	6	5.0	2.5	3.57	4.35
FH19S-9S-0.5SH(51)	586-1120-5-51	9	6.5	4.0	5.07	5.85
FH19S-10S-0.5SH(51)	586-1118-3-51	10	7.0	4.5	5.57	6.35
FH19S-12S-0.5SH(51)	586-1105-1-51	12	8.0	5.5	6.57	7.35
FH19S-13S-0.5SH(51)	Reserved for product expansion	13	8.5	6.0	7.07	7.85
FH19S-14S-0.5SH(51)	586-1113-0-51	14	9.0	6.5	7.57	8.35
FH19S-16S-0.5SH(51)	586-1112-7-51	16	10.0	7.5	8.57	9.35
FH19S-17S-0.5SH(51)	586-1100-8-51	17	10.5	8.0	9.07	9.85
FH19S-18S-0.5SH(51)	586-1110-1-51	18	11.0	8.5	9.57	10.35
FH19S-20S-0.5SH(51)	586-1101-0-51	20	12.0	9.5	10.57	11.35
FH19S-21S-0.5SH(51)	Reserved product expansion	21	12.5	10.0	11.07	11.85
FH19S-22S-0.5SH(51)	586-1108-0-51	22	13.0	10.5	11.57	12.35
FH19S-24S-0.5SH(51)	586-1102-3-51	24	14.0	11.5	12.57	13.35
FH19S-26S-0.5SH(51)	586-1104-9-51	26	15.0	12.5	13.57	14.35
FH19S-27S-0.5SH(51)	586-1103-6-51	27	15.5	13.0	14.07	14.85
FH19S-30S-0.5SH(51)	586-1109-2-51	30	17.0	14.5	15.57	16.35
FH19S-32S-0.5SH(51)	586-1121-8-51	32	18.0	15.5	16.57	17.35
FH19S-45S-0.5SH(51)	586-1111-4-51	45	24.5	22.0	23.07	23.85
FH19S-50S-0.5SH(51)	586-1107-7-51	50	27.0	24.5	25.57	26.35

Note: Embossed tape reel packaging (5,000 pieces/reel) .

Order by number of reels.

◆ Recommended PCB Land and Metal Mask Dimensions

[Common to FH19 & FH19S Series]

Recommended metal mask thickness: 0.10 mm.

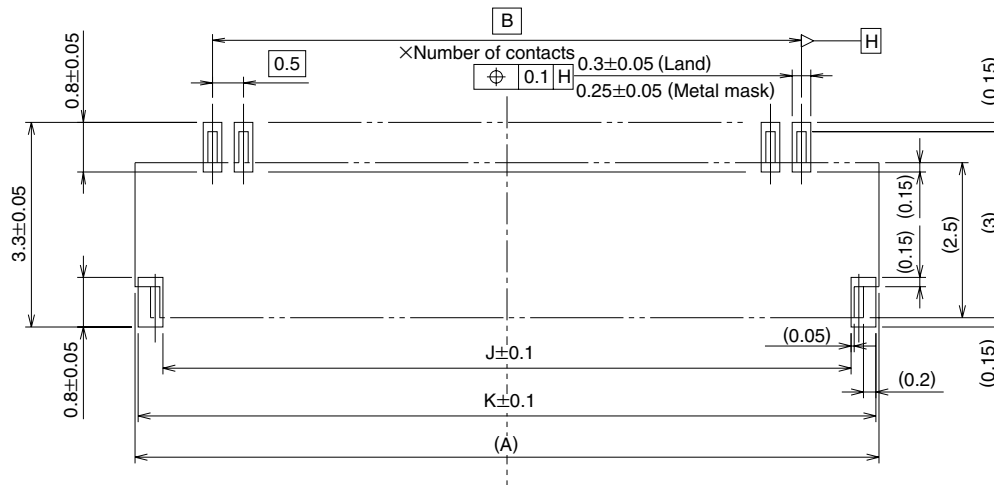

◆ Recommended FPC, FFC Dimensions

[Common to FH19 & FH19S Series]

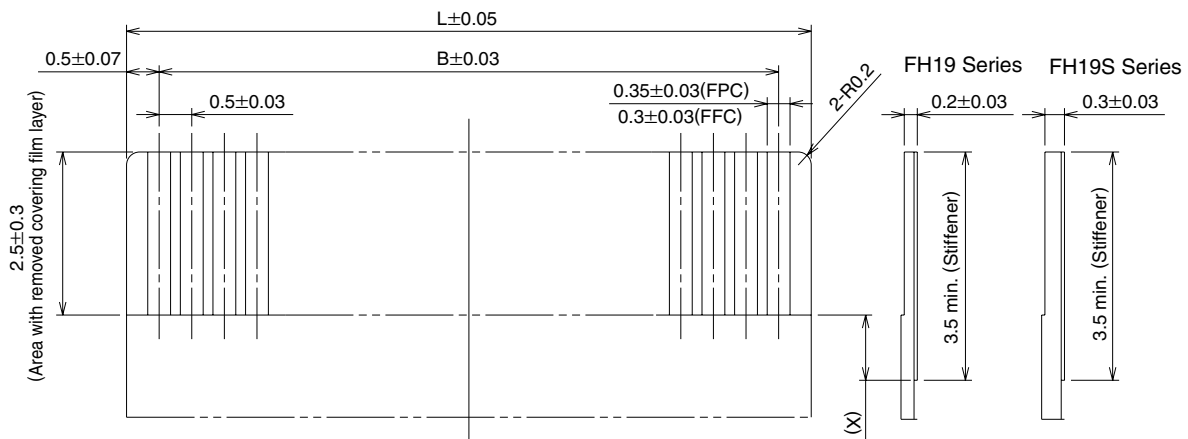

Note1: Polyamide and a thermally hardened adhesive is recommended as the materials for the stiffener.

Note2: Y dimension should be 1.5mm min., and X dimension should be 1.5mm for improved flexibility of FPC.

Unit: mm

Number of Contacts	A	B	J	K	L
4	4.0	1.5	3.1	3.9	2.5
5	4.5	2.0	3.6	4.4	3.0
6	5.0	2.5	4.1	4.9	3.5
8	6.0	3.5	5.1	5.9	4.5
9	6.5	4.0	5.6	6.4	5.0
10	7.0	4.5	6.1	6.9	5.5
12	8.0	5.5	7.1	7.9	6.5
13	8.5	6.0	7.6	8.4	7.0
14	9.0	6.5	8.1	8.9	7.5
15	9.5	7.0	8.6	9.4	8.0
16	10.0	7.5	9.1	9.9	8.5
17	10.5	8.0	9.6	10.4	9.0
18	11.0	8.5	10.1	10.9	9.5
20	12.0	9.5	11.1	11.9	10.5

Unit: mm

Number of Contacts	A	B	J	K	L
21	12.5	10.0	11.6	12.4	11.0
22	13.0	10.5	12.1	12.9	11.5
24	14.0	11.5	13.1	13.9	12.5
26	15.0	12.5	14.1	14.9	13.5
27	15.5	13.0	14.6	15.4	14.0
30	17.0	14.5	16.1	16.9	15.5
32	18.0	15.5	17.1	17.9	16.5
40	22.0	19.5	21.1	21.9	20.5
45	24.5	22.0	23.6	24.4	23.0
50	27.0	24.5	26.1	26.9	25.5

◆ Packaging Specifications

[Common to FH19 & FH19S Series]

● Embossed Carrier Tape Dimensions

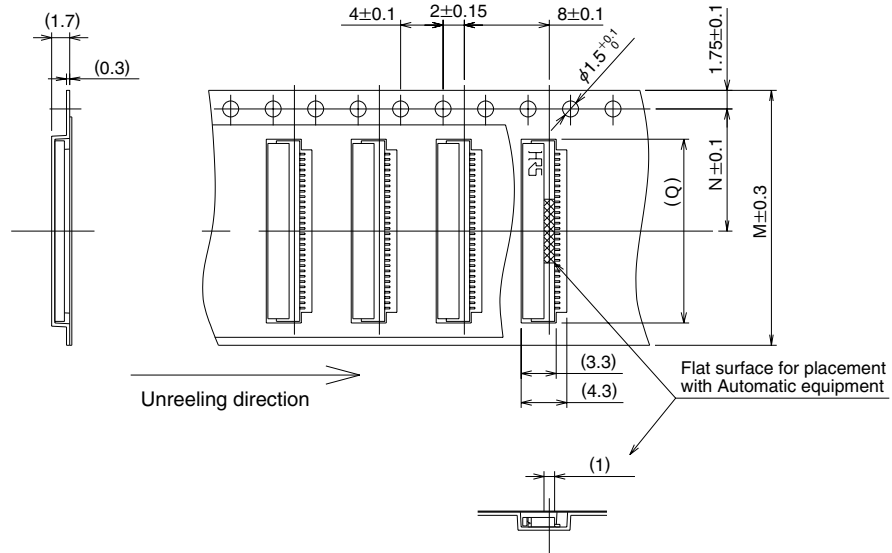

● Reel Dimensions

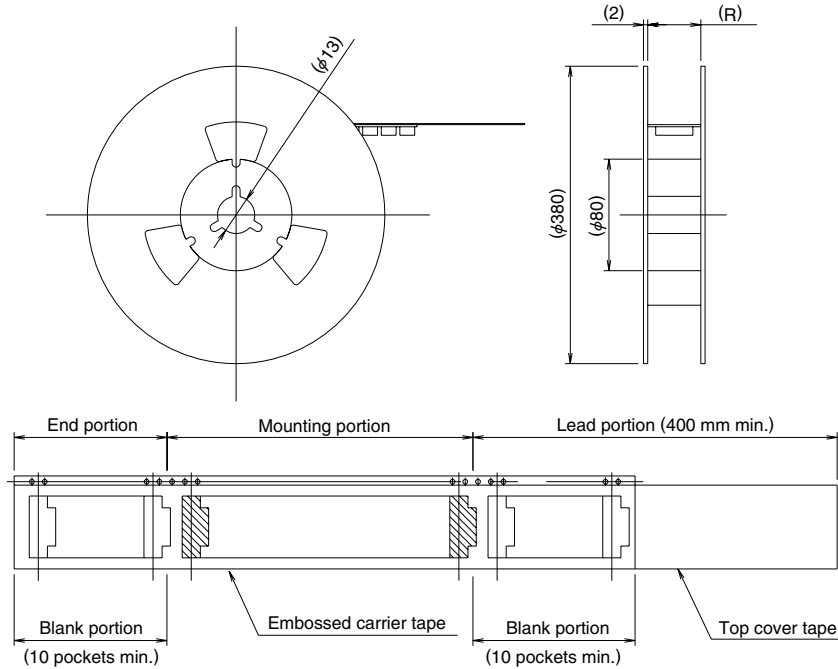

Unit: mm

Number of Contacts	M	N	Q	R
4	16	7.5	4.3	16.5
5	16	7.5	4.8	16.5
6	16	7.5	5.3	16.5
8	16	7.5	6.3	16.5
9	16	7.5	6.8	16.5
10	16	7.5	7.3	16.5
12	16	7.5	8.3	16.5
13	16	7.5	8.8	16.5
14	16	7.5	9.3	16.5
15	16	7.5	9.8	16.5
16	24	11.5	10.3	24.5
17	24	11.5	10.8	24.5
18	24	11.5	11.3	24.5
20	24	11.5	12.3	24.5

Unit: mm

Number of Contacts	M	N	Q	R
21	24	11.5	12.8	24.5
22	24	11.5	13.3	24.5
24	24	11.5	14.3	24.5
26	24	11.5	15.3	24.5
27	24	11.5	15.8	24.5
30	24	11.5	17.3	24.5
32	32	14.2	18.3	32.5
40	44	20.2	22.3	44.5
45	44	20.2	24.8	44.5
50	44	20.2	27.3	44.5

Notes: 5,000 pieces per reel.

Embossed tape 32 mm or wider will have perforated feed holes on two sides.

◆ Recommended Temperature Profile

[For FH19 & FH19S Series]

● Using Typical Solder Paste

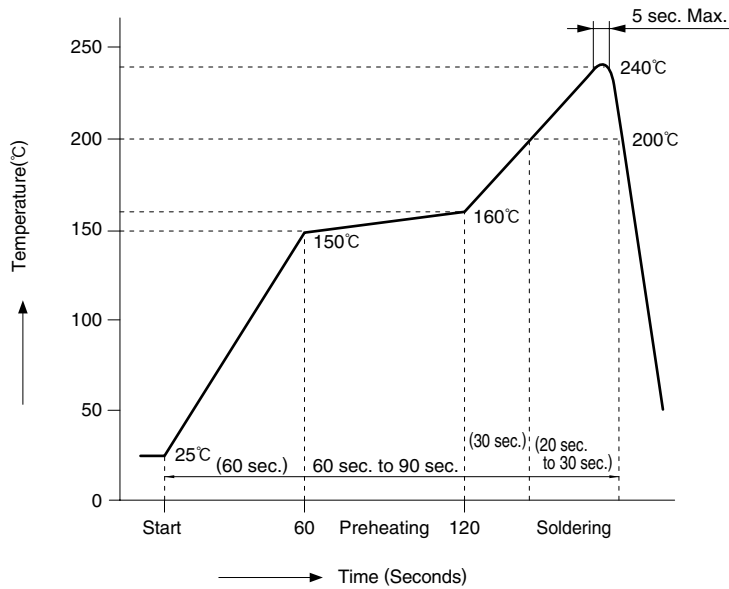

HRS test conditions

Solder method	:Reflow, IR/hot air (Nihon Den-netsu Co., Ltd.'s Part Number: SENSBY NR- II)
Environment	:Room air
Solder composition	:Paste, 63%Sn/37%Pb (Senju Metal Industry, Co., Ltd.'s Part Number: OZ63-201C-50-9)
Test board	:Glass epoxy 45mm×100mm×1.6mm thick
Land dimensions	:0.3mm×0.8mm
Metal mask	:0.25mm×0.8mm×0.1mm thick

This temperature profile is based on the above conditions. In individual applications the actual temperature may vary, depending on solder paste type, volume/thickness and board size/thickness. Consult your solder paste and equipment manufacturer for specific recommendations.

● Using Lead-free Solder paste

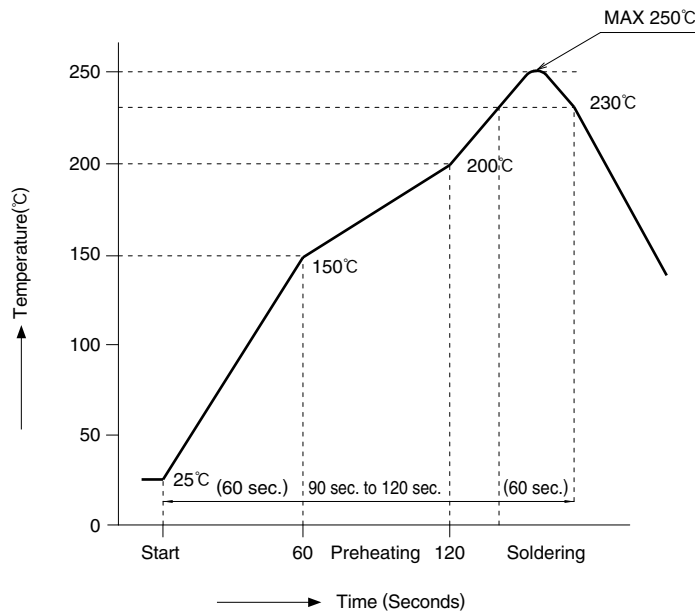

HRS test condition

Solder method	:Reflow, IR/hot air (Nihon Den-netsu Co., Ltd.'s Part Number: SENSBY NR- II)
Environment	:Room air
Solder composition	:Paste, 96.5%Sn/3.0%Ag/0.5%Cu (Senju Metal Industry, Co., Ltd.'s Part Number:M705-221CM5-42-10.5)
Test board	:Glass epoxy 45mm×100mm×1.6mm thick
Land dimensions	:0.3mm×0.8mm
Metal mask	:0.25mm×0.8mm×0.1mm

In individual applications the actual temperature may vary, depending on solder paste type, volume/thickness and board size/thickness. Consult your solder paste and equipment manufacturer for specific recommendations.

◆FH19 & FH19S Series FPC/FFC Construction (Recommended Specifications)

1. Using Single-sided FPC

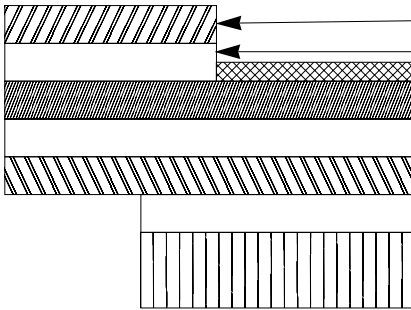

FPC : Flexible Printed Circuit

Material Name	Material	Thickness (μm)	
		FH19	FH19S
Covering film layer.	Polyamide 1 mil thick	25	25
Cover adhesive		25	25
Surface treatment	Tin-lead plating	5	5
Copper foil	Cu 1oz	35	35
Base adhesive		25	25
Base film	Polyamide 1 mil thick	25	25
Reinforcement material adhesive	Heat-hardened adhesive	30	30
Stiffener	Polyamide 3 mil thick	75	175
Total		195	295

2. Dual-sided FPC

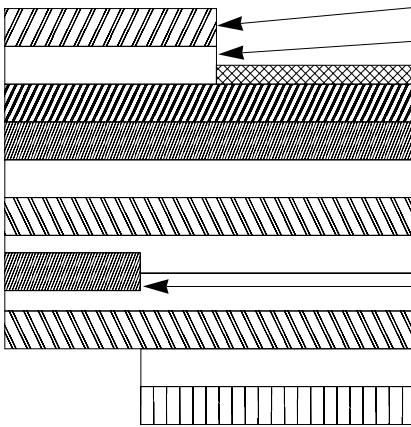

FPC : Flexible Printed Circuit

Material Name	Material	Thickness (μm)	
		FH19	FH19S
Covering layer film	Polyamide 1 mil thick	25	25
Cover adhesive		25	25
Surface treatment	Tin-lead plating	5	5
Through-hole copper	Cu	15	15
Copper foil	Cu 1/2oz	18	18
Base adhesive		18	18
Base film	Polyamide 1 mil thick	25	25
Base adhesive		18	18
Copper foil	Cu 1/2oz	18	18
Cover adhesive		25	25
Covering layer film	Polyamide 1 mil thick	25	25
Reinforcement material adhesive	Heat-hardened adhesive	25	50
Stiffener	Polyamide 1 mil thick	25	100
Total		199	299

3. Using FFC (Flexible Flat Cable)

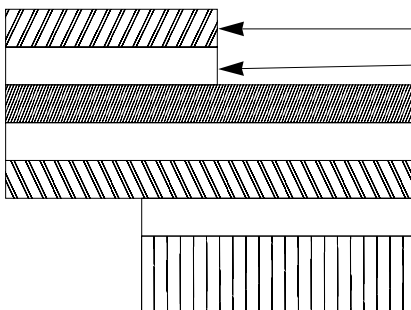

FFC : Flexible Flat Cable

Material Name	Material	Thickness (μm)	
		FH19	FH19S
Polyester film		12	12
Adhesive	Polyester thermoplastic type	30	30
Tin plated, soft copper film		35	35
Adhesive	Polyester	30	30
Polyester		12	12
Adhesive	Polyester	30	30
Stiffener	Polyester	100	188
Total		207	295

* Practical tolerance of thickness dimension is $\pm 20\mu\text{m}$ (i.e., 187 to 227 μm).

Note 1: The 0.2mm thick FFC is the 0.3mm thick FFC with different stiffener.

Note 2: This specification is a recommendation for the FH19, FH19S Series connectors using FPC/FFC 0.2/0.3 $\pm 0.03\text{mm}$ thick.