

# FS2VS-12

HIGH-SPEED SWITCHING USE

## FS2VS-12



- V<sub>DSS</sub> ..... 600V
- r<sub>DS (ON)</sub> (MAX) ..... 6.4Ω
- I<sub>D</sub> ..... 2A

## OUTLINE DRAWING

Dimensions in mm

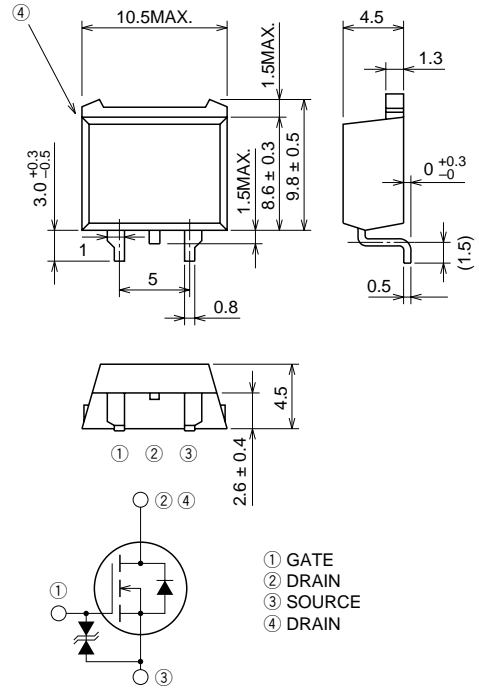

TO-220S

## APPLICATION

SMPS, DC-DC Converter, battery charger, power supply of printer, copier, HDD, FDD, TV, VCR, personal computer etc.

## MAXIMUM RATINGS (T<sub>c</sub> = 25°C)

| Symbol           | Parameter                 | Conditions           | Ratings    | Unit |
|------------------|---------------------------|----------------------|------------|------|
| V <sub>DSS</sub> | Drain-source voltage      | V <sub>GS</sub> = 0V | 600        | V    |
| V <sub>GSS</sub> | Gate-source voltage       | V <sub>DS</sub> = 0V | ±30        | V    |
| I <sub>D</sub>   | Drain current             |                      | 2          | A    |
| I <sub>DM</sub>  | Drain current (Pulsed)    |                      | 6          | A    |
| P <sub>D</sub>   | Maximum power dissipation |                      | 60         | W    |
| T <sub>ch</sub>  | Channel temperature       |                      | -55 ~ +150 | °C   |
| T <sub>stg</sub> | Storage temperature       |                      | -55 ~ +150 | °C   |
| —                | Weight                    | Typical value        | 1.2        | g    |

**ELECTRICAL CHARACTERISTICS** (T<sub>ch</sub> = 25°C)

| Symbol                 | Parameter                        | Test conditions  | Limits |      |      | Unit |
|------------------------|----------------------------------|--|--------|------|------|------|
|                        |                                  |  | Min.   | Typ. | Max. |      |
| V (BR) DSS             | Drain-source breakdown voltage   | I <sub>D</sub> = 1mA, V <sub>GS</sub> = 0V   | 600    | —    | —    | V    |
| V (BR) GSS             | Gate-source breakdown voltage    | I <sub>G</sub> = ±100μA, V <sub>DS</sub> = 0V  | ±30    | —    | —    | V    |
| I <sub>GSS</sub>       | Gate-source leakage current      | V <sub>GS</sub> = ±25V, V <sub>DS</sub> = 0V   | —      | —    | ±10  | μA   |
| I <sub>DSS</sub>       | Drain-source leakage current     | V <sub>DS</sub> = 600V, V <sub>GS</sub> = 0V   | —      | —    | 1    | mA   |
| V <sub>GS</sub> (th)   | Gate-source threshold voltage    | I <sub>D</sub> = 1mA, V <sub>DS</sub> = 10V  | 2      | 3    | 4    | V    |
| r <sub>DS</sub> (ON)   | Drain-source on-state resistance | I <sub>D</sub> = 1A, V <sub>GS</sub> = 10V   | —      | 5.0  | 6.4  | Ω    |
| V <sub>DS</sub> (ON)   | Drain-source on-state voltage    | I <sub>D</sub> = 1A, V <sub>GS</sub> = 10V   | —      | 5.0  | 6.4  | V    |
| y <sub>fs</sub>        | Forward transfer admittance      | I <sub>D</sub> = 1A, V <sub>DS</sub> = 10V   | 0.8    | 1.3  | —    | S    |
| C <sub>iss</sub>       | Input capacitance                | V <sub>DS</sub> = 25V, V <sub>GS</sub> = 0V, f = 1MHz  | —      | 300  | —    | pF   |
| C <sub>oss</sub>       | Output capacitance               |  | —      | 30   | —    | pF   |
| C <sub>rss</sub>       | Reverse transfer capacitance     |  | —      | 5    | —    | pF   |
| t <sub>d</sub> (on)    | Turn-on delay time               | V <sub>DD</sub> = 200V, I <sub>D</sub> = 1A, V <sub>GS</sub> = 10V, R <sub>GEN</sub> = R <sub>GS</sub> = 50Ω | —      | 13   | —    | ns   |
| t <sub>r</sub>         | Rise time                        |  | —      | 10   | —    | ns   |
| t <sub>d</sub> (off)   | Turn-off delay time              |  | —      | 30   | —    | ns   |
| t <sub>f</sub>         | Fall time                        |  | —      | 30   | —    | ns   |
| V <sub>SD</sub>        | Source-drain voltage             | I <sub>S</sub> = 1A, V <sub>GS</sub> = 0V  | —      | 1.5  | 2.0  | V    |
| R <sub>th</sub> (ch-c) | Thermal resistance               | Channel to case  | —      | —    | 2.08 | °C/W |

**PERFORMANCE CURVES**

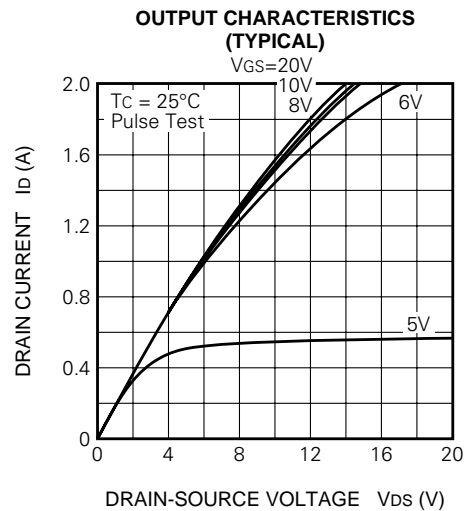
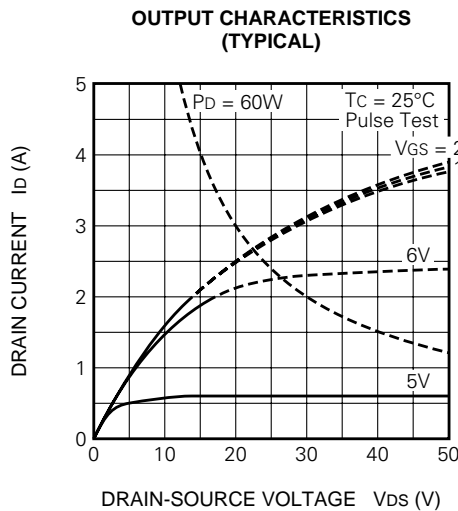
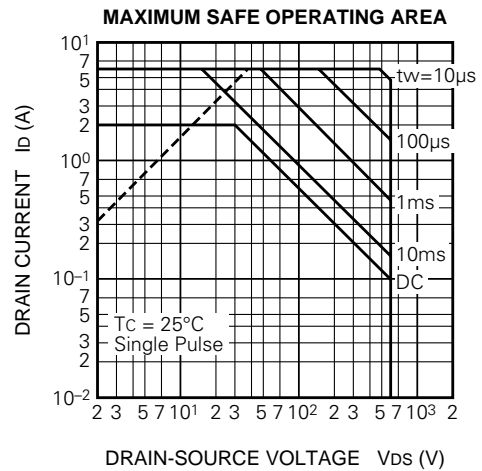
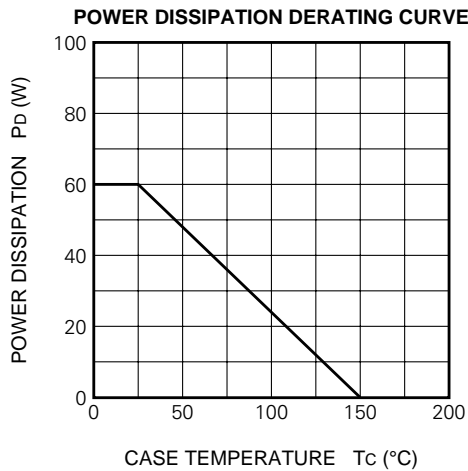

ON-STATE VOLTAGE VS. GATE-SOURCE VOLTAGE (TYPICAL)

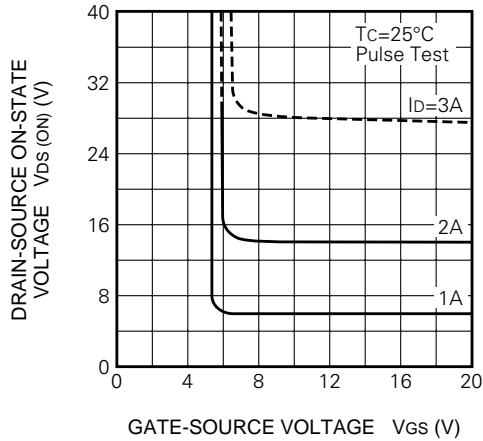

ON-STATE RESISTANCE VS. DRAIN CURRENT (TYPICAL)

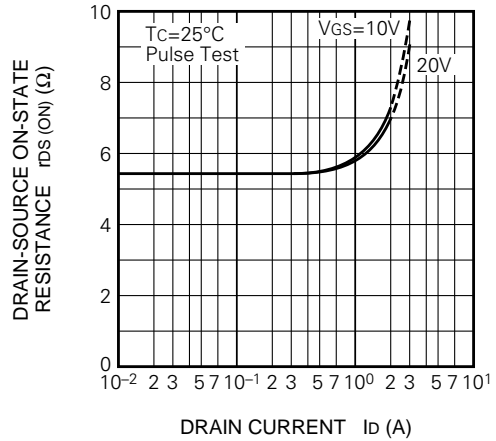

TRANSFER CHARACTERISTICS (TYPICAL)

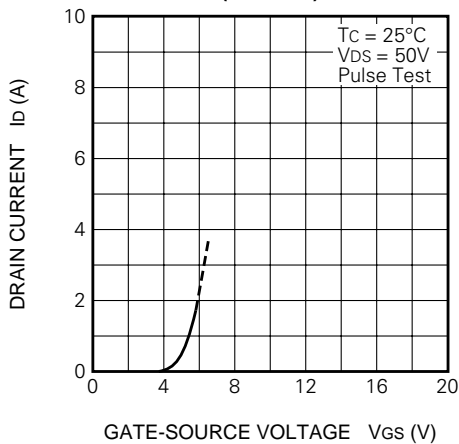

FORWARD TRANSFER ADMITTANCE VS. DRAIN CURRENT (TYPICAL)

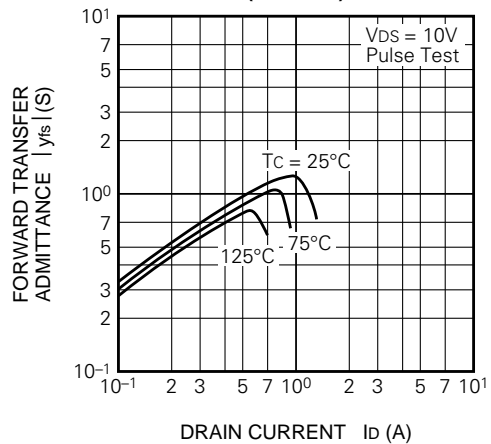

CAPACITANCE VS. DRAIN-SOURCE VOLTAGE (TYPICAL)

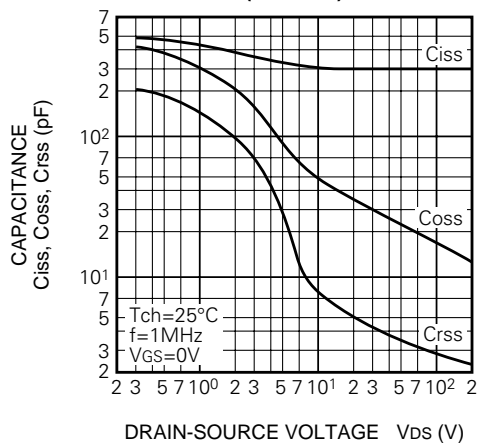

SWITCHING CHARACTERISTICS (TYPICAL)

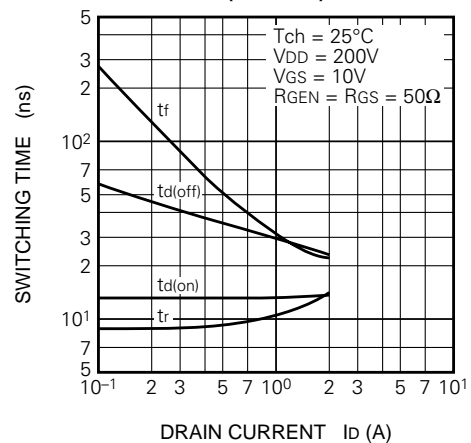

**GATE-SOURCE VOLTAGE VS. GATE CHARGE (TYPICAL)**

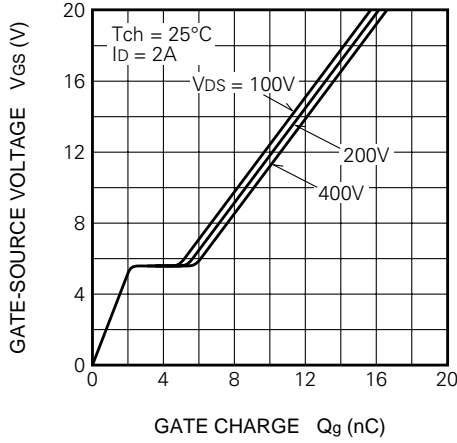

**SOURCE-DRAIN DIODE FORWARD CHARACTERISTICS (TYPICAL)**

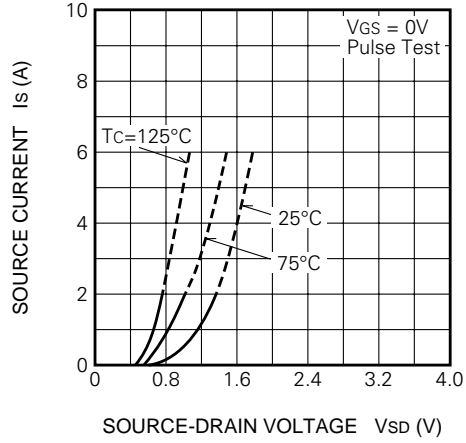

**ON-STATE RESISTANCE VS. CHANNEL TEMPERATURE (TYPICAL)**

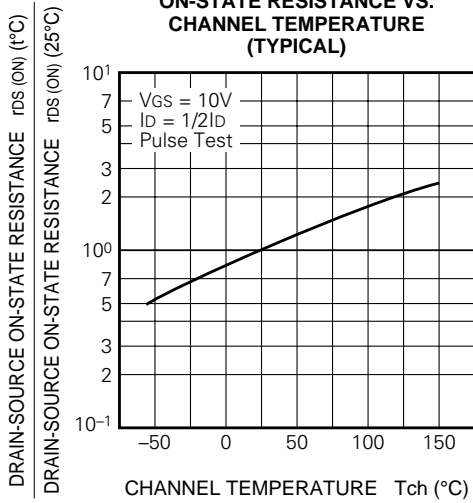

**THRESHOLD VOLTAGE VS. CHANNEL TEMPERATURE (TYPICAL)**

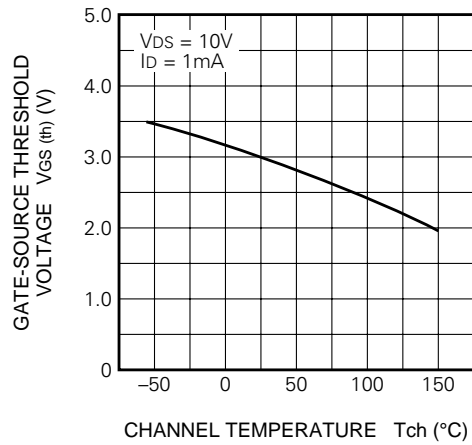

**BREAKDOWN VOLTAGE VS. CHANNEL TEMPERATURE (TYPICAL)**

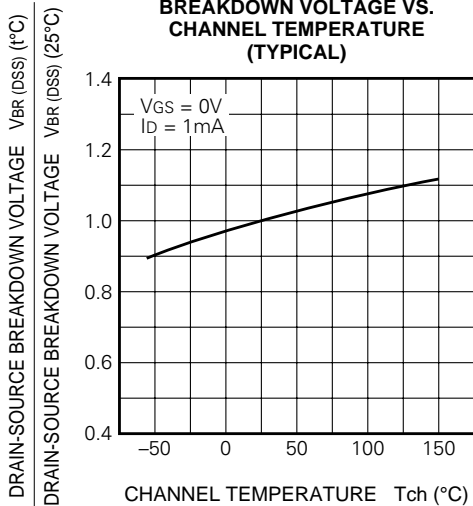

**TRANSIENT THERMAL IMPEDANCE CHARACTERISTICS**

