

FS70UM-2

HIGH-SPEED SWITCHING USE

FS70UM-2



- 10V DRIVE
- V_{DSS} 100V
- $r_{DS(ON)}(MAX)$ 20m Ω
- I_D 70A
- Integrated Fast Recovery Diode (TYP.) 120ns

OUTLINE DRAWING

Dimensions in mm

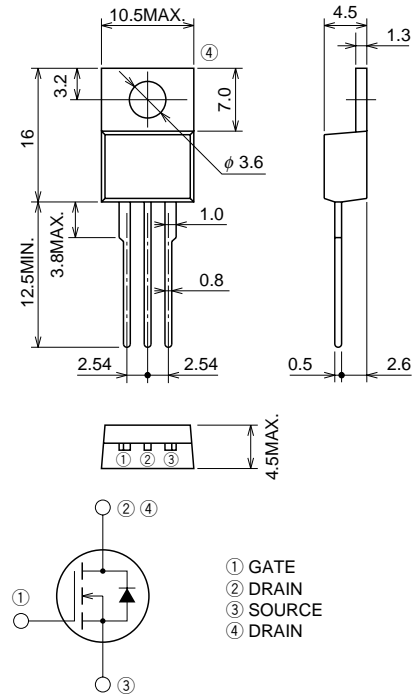

TO-220

APPLICATION

Motor control, Lamp control, Solenoid control
DC-DC converter, etc.

MAXIMUM RATINGS (Tc = 25°C)

Symbol	Parameter	Conditions	Ratings	Unit
V_{DSS}	Drain-source voltage	$V_{GS} = 0V$	100	V
V_{GSS}	Gate-source voltage	$V_{DS} = 0V$	± 20	V
I_D	Drain current		70	A
I_{DM}	Drain current (Pulsed)		280	A
I_{DA}	Avalanche drain current (Pulsed)	$L = 100\mu H$	70	A
I_S	Source current		70	A
I_{SM}	Source current (Pulsed)		280	A
P_D	Maximum power dissipation		125	W
T_{ch}	Channel temperature		-55 ~ +150	°C
T_{stg}	Storage temperature		-55 ~ +150	°C
—	Weight	Typical value	2.0	g

FS70UM-2

HIGH-SPEED SWITCHING USE

ELECTRICAL CHARACTERISTICS (Tch = 25°C)

Symbol	Parameter	Test conditions	Limits			Unit
			Min.	Typ.	Max.	
V(BR)DSS	Drain-source breakdown voltage	Id = 1mA, Vgs = 0V	100	—	—	V
IgSS	Gate-source leakage current	Vgs = ±20V, Vds = 0V	—	—	±0.1	μA
IbSS	Drain-source leakage current	Vds = 100V, Vgs = 0V	—	—	0.1	mA
VGS(th)	Gate-source threshold voltage	Id = 1mA, Vds = 10V	2.0	3.0	4.0	V
rDS(ON)	Drain-source on-state resistance	Id = 35A, Vgs = 10V	—	14	20	mΩ
VDS(ON)	Drain-source on-state voltage	Id = 35A, Vgs = 10V	—	0.49	0.7	V
yfs	Forward transfer admittance	Id = 35A, Vds = 10V	—	53	—	S
Ciss	Input capacitance	Vds = 10V, Vgs = 0V, f = 1MHz	—	6540	—	pF
Coss	Output capacitance		—	1150	—	pF
Crss	Reverse transfer capacitance		—	500	—	pF
td(on)	Turn-on delay time		—	95	—	ns
tr	Rise time	VDD = 50V, Id = 35A, Vgs = 10V, RGEN = RGS = 50Ω	—	175	—	ns
td(off)	Turn-off delay time		—	330	—	ns
tf	Fall time		—	190	—	ns
VSD	Source-drain voltage		Is = 35A, Vgs = 0V	—	1.0	1.5
Rth(ch-c)	Thermal resistance	Channel to case	—	—	1.00	°C/W
trr	Reverse recovery time	Is = 70A, dis/dt = -100A/μs	—	120	—	ns

PERFORMANCE CURVES

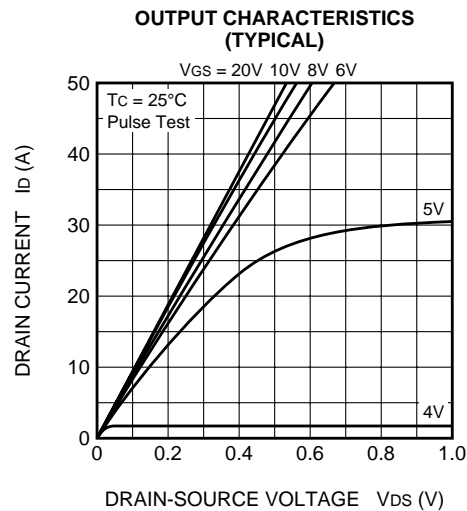
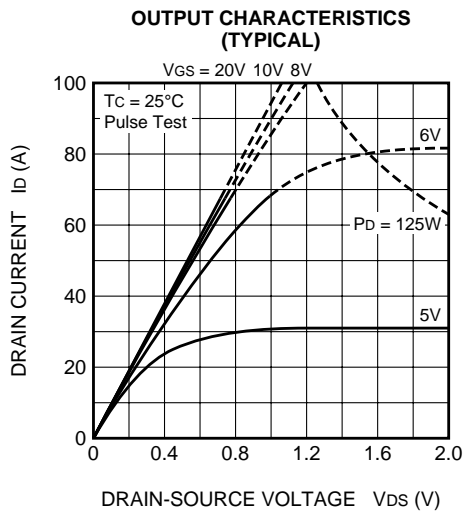
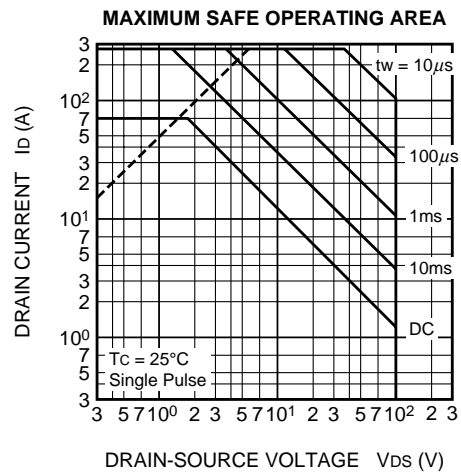
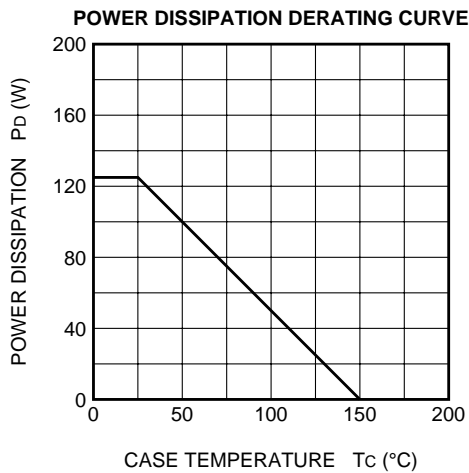

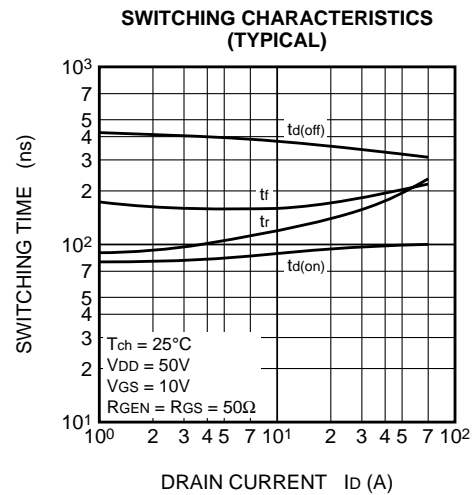
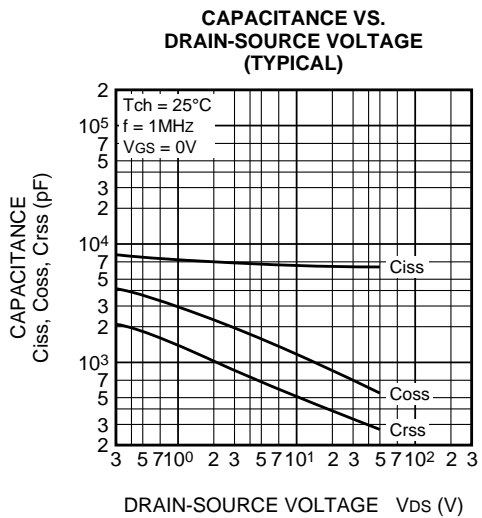
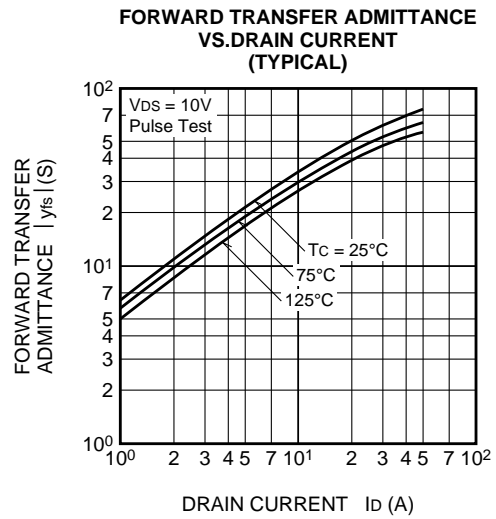
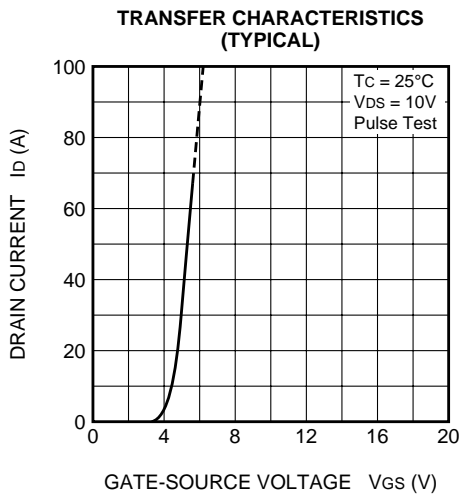
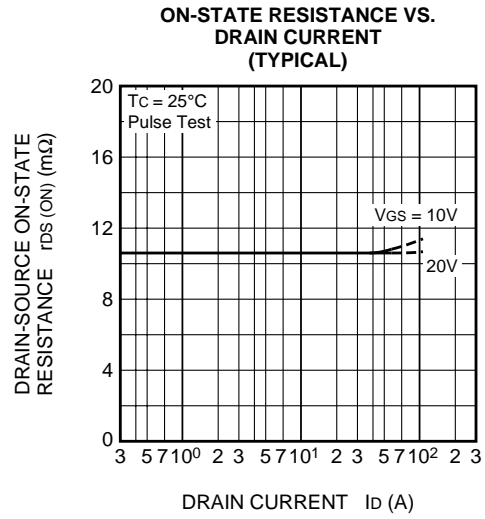
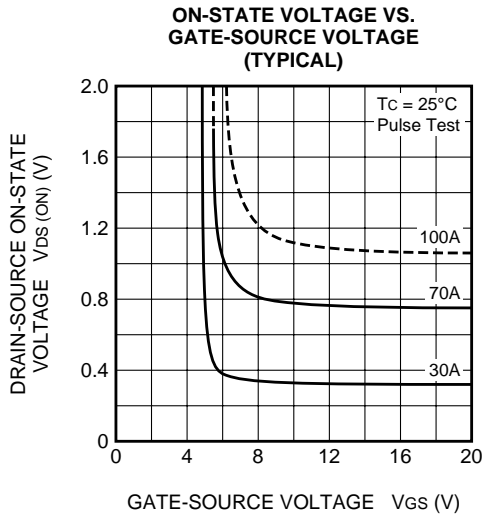

GATE-SOURCE VOLTAGE VS. GATE CHARGE (TYPICAL)

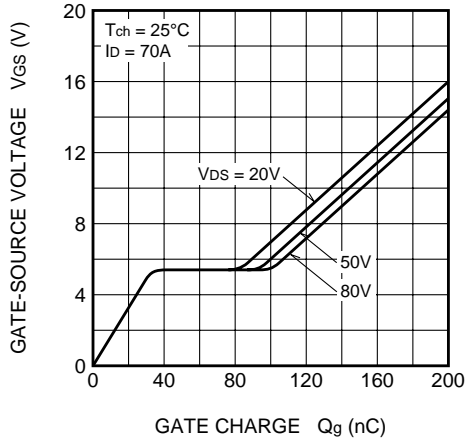

SOURCE-DRAIN DIODE FORWARD CHARACTERISTICS (TYPICAL)

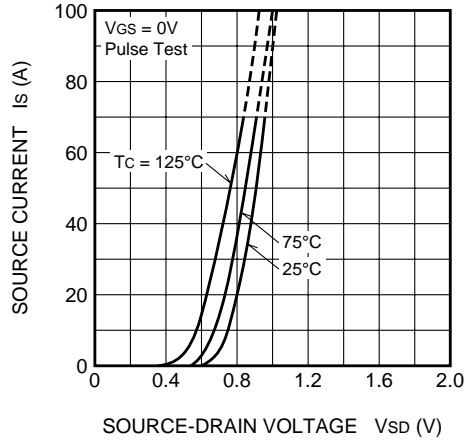

ON-STATE RESISTANCE VS. CHANNEL TEMPERATURE (TYPICAL)

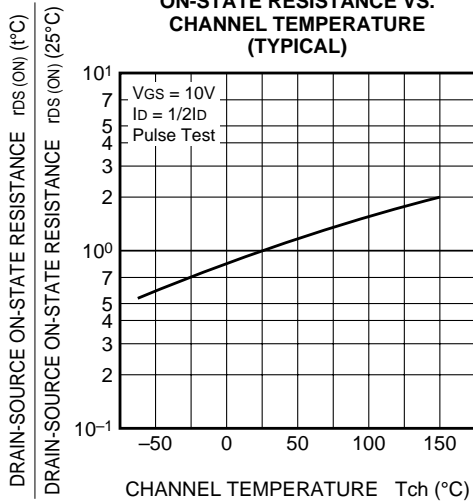

THRESHOLD VOLTAGE VS. CHANNEL TEMPERATURE (TYPICAL)

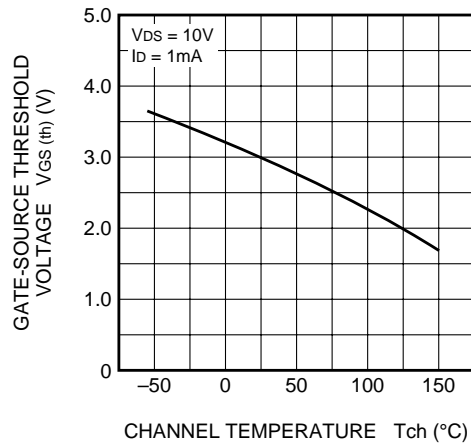

BREAKDOWN VOLTAGE VS. CHANNEL TEMPERATURE (TYPICAL)

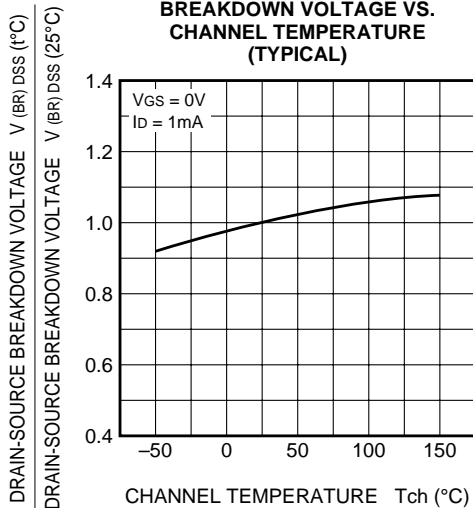

TRANSIENT THERMAL IMPEDANCE CHARACTERISTICS

