

FY6ACH-02A

HIGH-SPEED SWITCHING USE

FY6ACH-02A

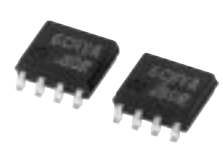

- 2.5V DRIVE
- V_{DSS} 20V
- r_{DS (ON)} (MAX) 30mΩ
- I_D 6A

OUTLINE DRAWING Dimensions in mm

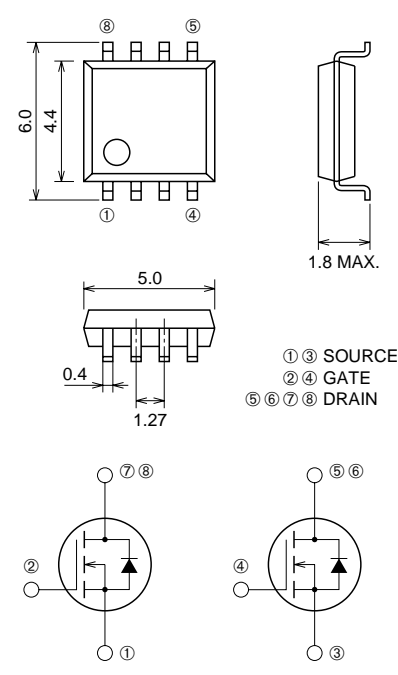

① ③ SOURCE
② ④ GATE
⑤ ⑥ ⑦ ⑧ DRAIN

SOP-8

APPLICATION

Motor control, Lamp control, Solenoid control
DC-DC converter, etc.

MAXIMUM RATINGS (T_c = 25°C)

Symbol	Parameter	Conditions	Ratings	Unit
V _{DSS}	Drain-source voltage	V _{GS} = 0V	20	V
V _{GSS}	Gate-source voltage	V _{DS} = 0V	±10	V
I _D	Drain current		6	A
I _{DM}	Drain current (Pulsed)		42	A
I _{DA}	Avalanche drain current (Pulsed)	L = 10μH	6	A
I _S	Source current		1.7	A
I _{SM}	Source current (Pulsed)		6.8	A
P _D	Maximum power dissipation		1.6	W
T _{ch}	Channel temperature		-55 ~ +150	°C
T _{stg}	Storage temperature		-55 ~ +150	°C
—	Weight	Typical value	0.07	g

ELECTRICAL CHARACTERISTICS (Tch = 25°C)

Symbol	Parameter	Test conditions	Limits			Unit
			Min.	Typ.	Max.	
V(BR)DSS	Drain-source breakdown voltage	Id = 1mA, VGS = 0V	20	—	—	V
IGSS	Gate-source leakage current	VGS = ±10V, VDS = 0V	—	—	±0.1	μA
IDSS	Drain-source leakage current	VDS = 20V, VGS = 0V	—	—	0.1	mA
VGS(th)	Gate-source threshold voltage	Id = 1mA, VDS = 10V	0.5	0.9	1.3	V
rDS(ON)	Drain-source on-state resistance	Id = 6A, VGS = 4V	—	25	30	mΩ
rDS(ON)	Drain-source on-state resistance	Id = 3A, VGS = 2.5V	—	32	40	mΩ
VDS(ON)	Drain-source on-state voltage	Id = 6A, VGS = 4V	—	0.15	0.18	V
yfs	Forward transfer admittance	Id = 6A, VDS = 10V	—	13	—	S
Ciss	Input capacitance	VDS = 10V, VGS = 0V, f = 1MHz	—	900	—	pF
Coss	Output capacitance		—	300	—	pF
Crss	Reverse transfer capacitance		—	170	—	pF
td(on)	Turn-on delay time	VDD = 10V, Id = 3A, VGS = 4V, RGEN = RGS = 50Ω	—	25	—	ns
tr	Rise time		—	65	—	ns
td(off)	Turn-off delay time		—	95	—	ns
tf	Fall time		—	90	—	ns
VSD	Source-drain voltage	IS = 1.7A, VGS = 0V	—	0.75	1.1	V
Rth(ch-a)	Thermal resistance	Channel to ambient	—	—	78.1	°C/W
trr	Reverse recovery time	IS = 1.7A, dis/dt = -50A/μs	—	100	—	ns

PERFORMANCE CURVES

POWER DISSIPATION DERATING CURVE

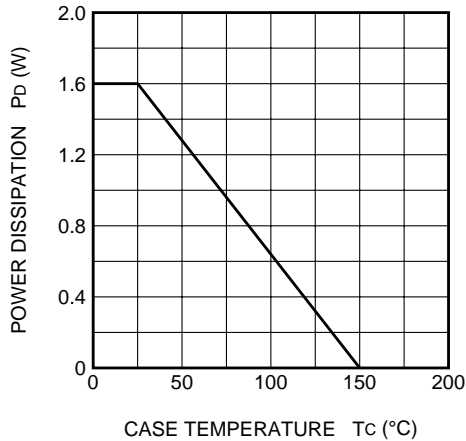

MAXIMUM SAFE OPERATING AREA

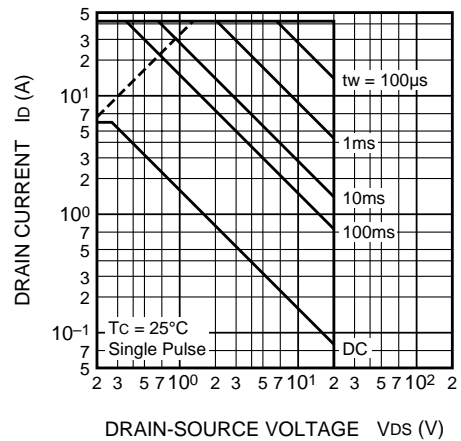

OUTPUT CHARACTERISTICS (TYPICAL)

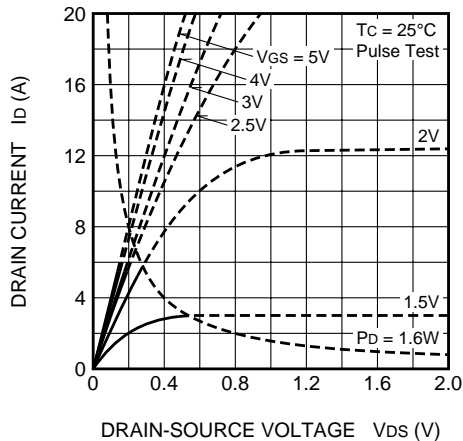

OUTPUT CHARACTERISTICS (TYPICAL)

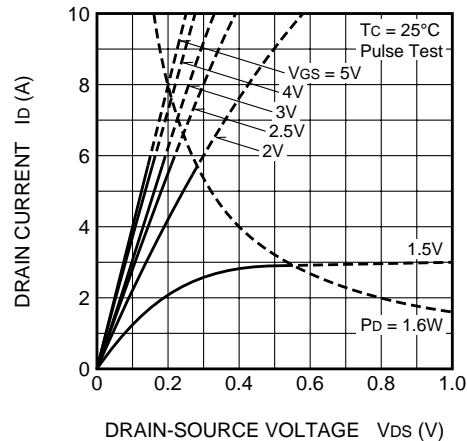

ON-STATE VOLTAGE VS. GATE-SOURCE VOLTAGE (TYPICAL)

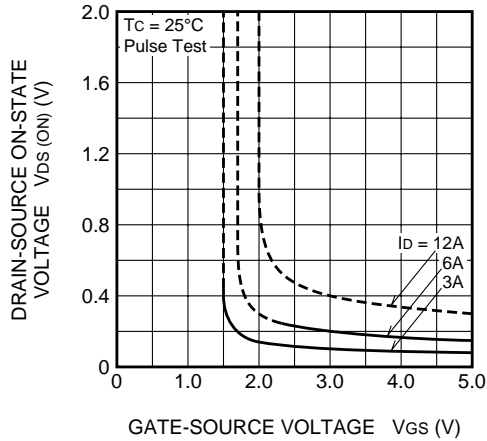

ON-STATE RESISTANCE VS. DRAIN CURRENT (TYPICAL)

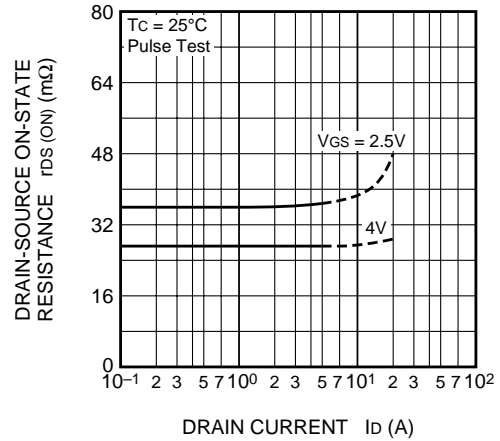

TRANSFER CHARACTERISTICS (TYPICAL)

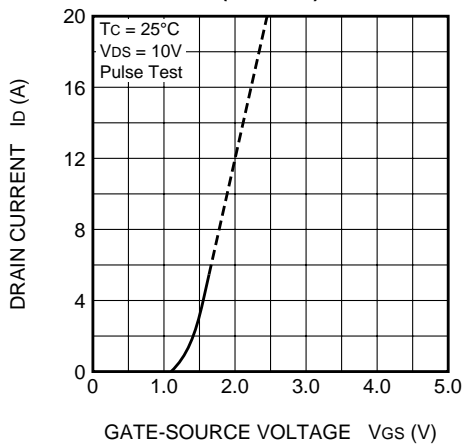

FORWARD TRANSFER ADMITTANCE VS. DRAIN CURRENT (TYPICAL)

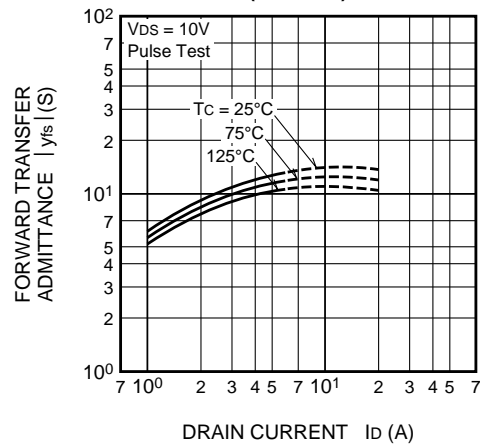

CAPACITANCE VS. DRAIN-SOURCE VOLTAGE (TYPICAL)

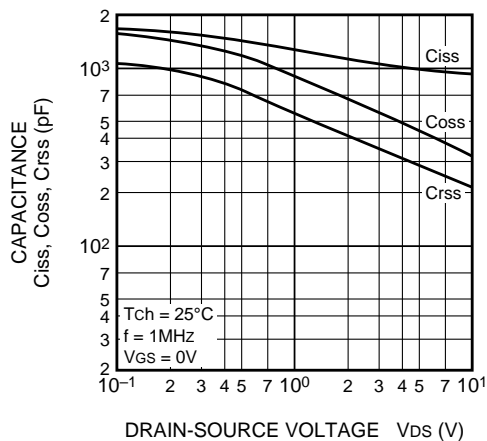

SWITCHING CHARACTERISTICS (TYPICAL)

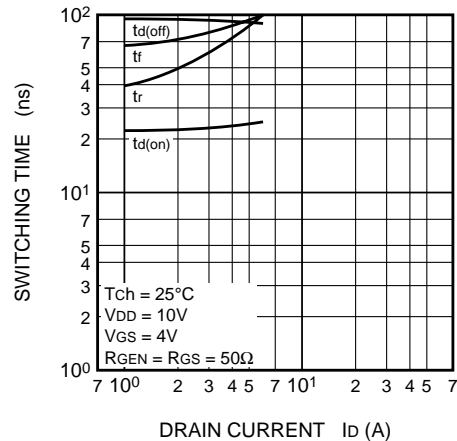

GATE-SOURCE VOLTAGE VS. GATE CHARGE (TYPICAL)

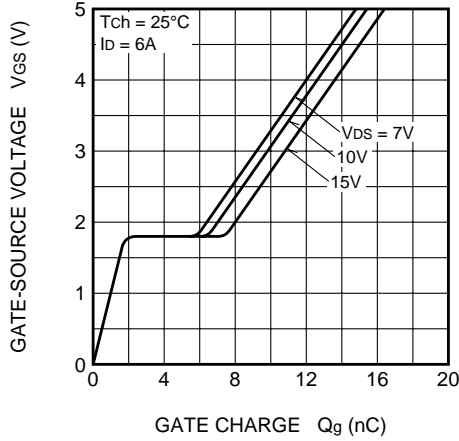

SOURCE-DRAIN DIODE FORWARD CHARACTERISTICS (TYPICAL)

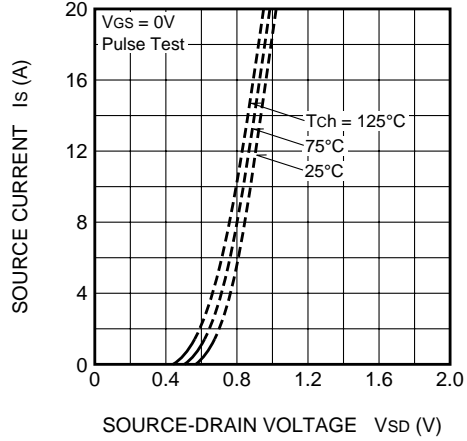

ON-STATE RESISTANCE VS. CHANNEL TEMPERATURE (TYPICAL)

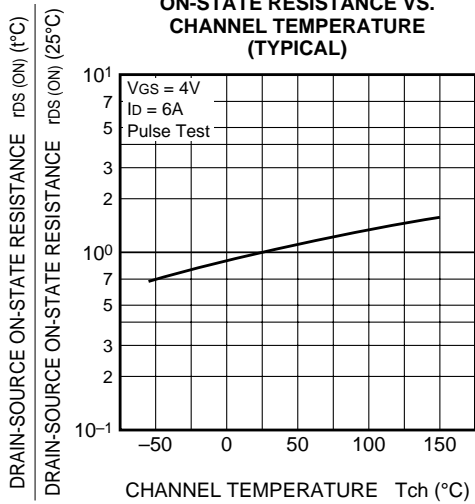

THRESHOLD VOLTAGE VS. CHANNEL TEMPERATURE (TYPICAL)

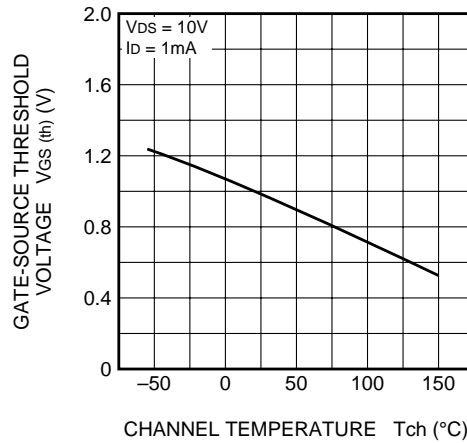

BREAKDOWN VOLTAGE VS. CHANNEL TEMPERATURE (TYPICAL)

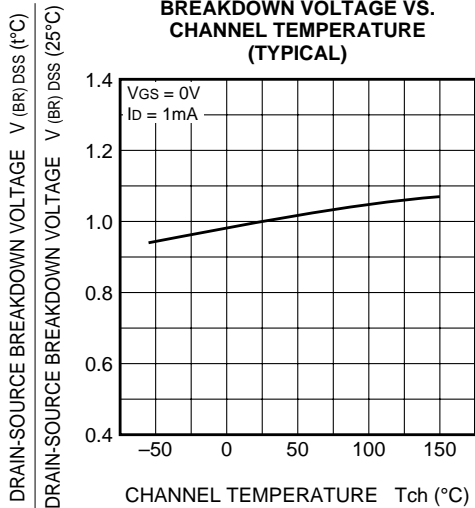

TRANSIENT THERMAL IMPEDANCE CHARACTERISTICS

