

# GP1S23

## Subminiature Photointerrupter

### ■ Features

1. Ultra-compact
2. PWB mounting type package
3. High sensing accuracy (Slit width: 0.3mm)
4. Gap between light emitter and detector: 2mm

### ■ Applications

1. Cameras
2. Floppy disk drives

### ■ Outline Dimensions

(Unit : mm)

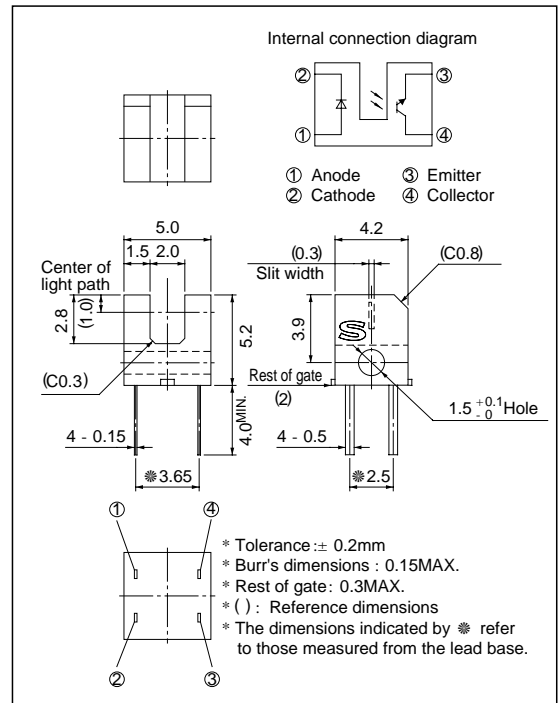

### ■ Absolute Maximum Ratings

( $T_a = 25^\circ\text{C}$ )

Parameter		Symbol	Rating	Unit
Input	Forward current	$I_F$	50	mA
	Reverse voltage	$V_R$	6	V
	Power dissipation	$P$	75	mW
Output	Collector-emitter voltage	$V_{CEO}$	35	V
	Emitter-collector voltage	$V_{ECO}$	6	V
	Collector current	$I_C$	20	mA
	Collector power dissipation	$P_C$	75	mW
Total power dissipation		$P_{tot}$	100	mW
Operating temperature		$T_{opr}$	- 25 to + 85	$^\circ\text{C}$
Storage temperature		$T_{stg}$	- 40 to + 100	$^\circ\text{C}$
*1 Soldering temperature		$T_{sol}$	260	$^\circ\text{C}$

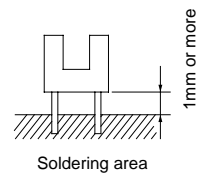

\*1 For 3 seconds

**Electro-optical Characteristics**

( $T_a = 25^\circ\text{C}$ )

Parameter		Symbol	Conditions	MIN.	TYP.	MAX.	Unit
Input	Forward voltage	$V_F$	$I_F = 20\text{mA}$	-	1.2	1.4	V
	Reverse current	$I_R$	$V_R = 3\text{V}$	-	-	10	$\mu\text{A}$
Output	Collector dark current	$I_{CEO}$	$V_{CE} = 20\text{V}$	-	-	$1 \times 10^{-7}$	A
Transfer-characteristics	Collector Current	$I_C$	$I_F = 5\text{mA}, V_{CE} = 5\text{V}$	40	-	400	$\mu\text{A}$
	Collector-emitter saturation voltage	$V_{CE(\text{sat})}$	$I_F = 10\text{mA}, I_C = 40\mu\text{A}$	-	-	0.4	V
	Response time	Rise time	$t_r$	$I_C = 0.1\text{mA}, V_{CE} = 5\text{V}, R_L = 1\text{k}\Omega$	-	50	150
Fall time		$t_f$	-		50	150	$\mu\text{s}$

**Fig. 1 Forward Current vs. Ambient Temperature**

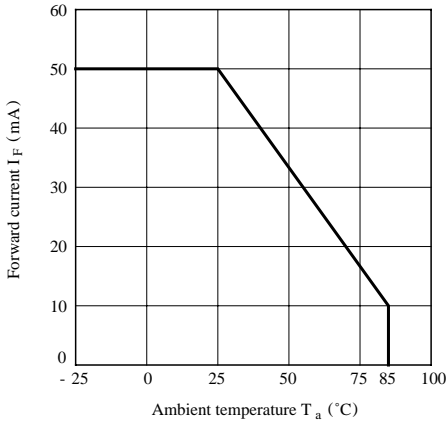

**Fig. 2 Power Dissipation vs. Ambient Temperature**

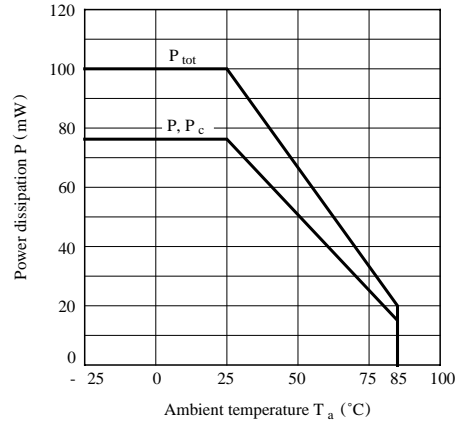

**Fig. 3 Forward Current vs. Forward Voltage**

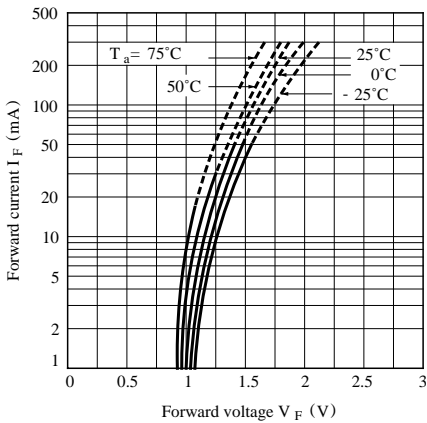

**Fig. 4 Collector Current vs. Forward Current**

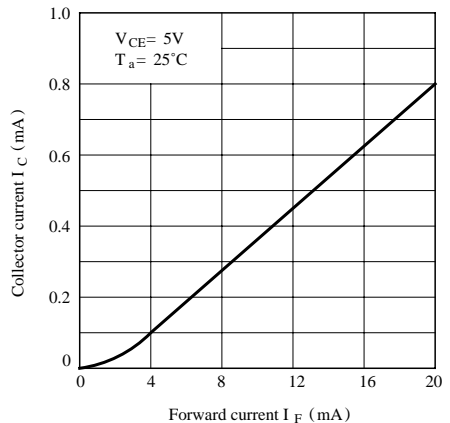

**Fig. 5 Collector Current vs. Collector-emitter voltage**

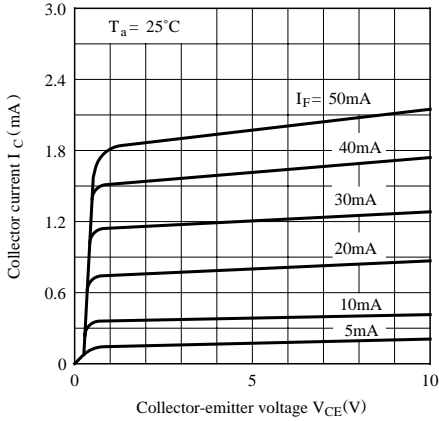

**Fig. 6 Collector Current vs. Ambient Temperature**

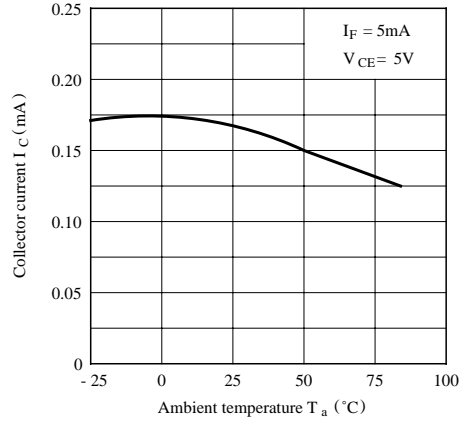

**Fig. 7 Collector-emitter Saturation Voltage vs. Ambient Temperature**

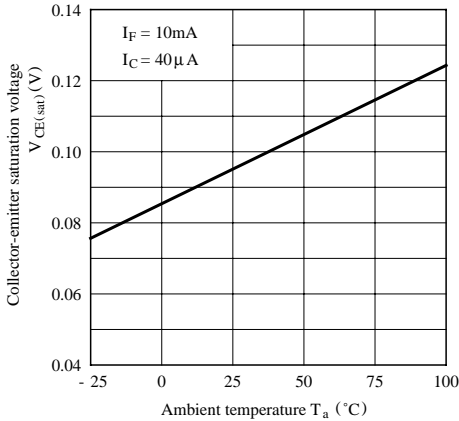

**Fig. 8 Collector Dark Current vs. Ambient Temperature**

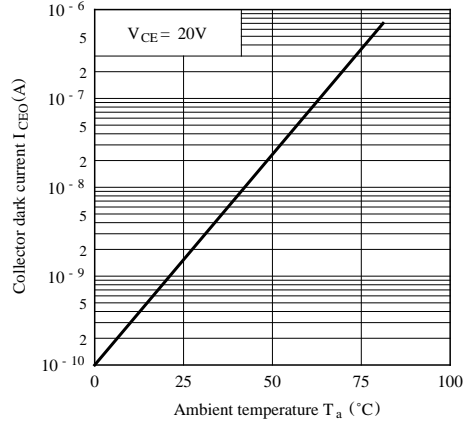

**Fig. 9 Response Time vs. Load Resistance**

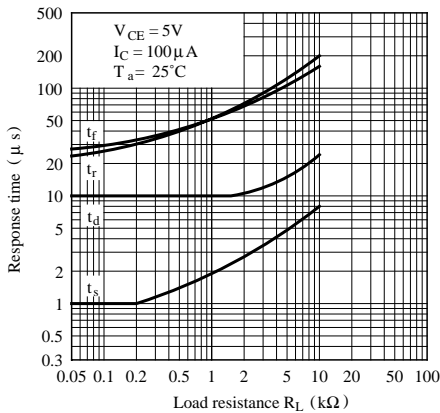

**Test Circuit for Response Time**

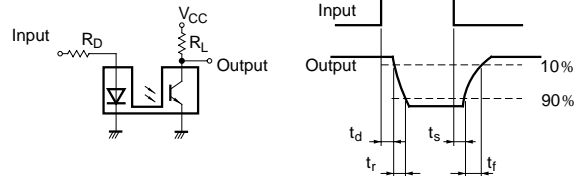

**Fig.10 Relative Collector Current vs. Shield Distance (1)**

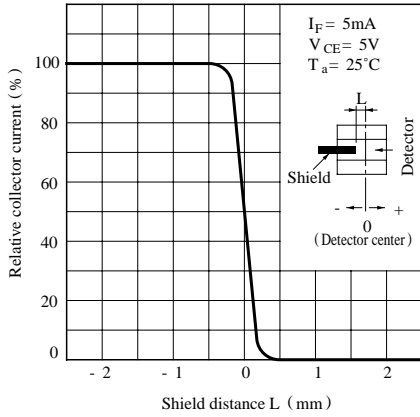

**Fig.11 Relative Collector Current vs. Shield Distance (2)**

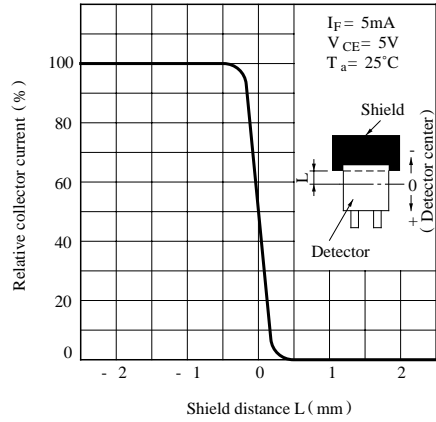

- Please refer to the chapter “Precautions for Use”.