

HFKW-SH

DOUBLE MAKE CONTACT AUTOMOTIVE RELAY



Typical Applications

Central door lock, Anti-theft lock, Lighting control

Features

- Small size
- Double NO contacts
- Standard terminal pitch employed
- Extended operation range
- Wash tight type available
- RoHS & ELV compliant

CHARACTERISTICS

Contact arrangement	1U (Double NO contacts)
Voltage drop (initial) ¹⁾	Typ.: 50mV (at 10A) Max.: 250mV (at 10A)
Contact rating	Lamp: 2×4A 14VDC (AgSnO ₂) Resistive: 2×6A 14VDC
Max. carrying current	2×20A/2min ²⁾
Max. shock current	2×30A
Max. switching power	2×10A 16VDC
Min.contact load	1A 6VDC
Electrical endurance	See " CONTACT DATA " table
Mechanical endurance	1 x 10 ⁷ OPS (300OPS/min)
Initial insulation resistance	100MΩ (at 500VDC)
Dielectric strength	500VAC (1min, leakage current less than 1mA)
Operate time	Max.: 10ms (at nomi. vol.)

Release time	Max.: 5ms ³⁾
Temperature rise (at nomi. vol.)	60K max.
Ambient temperature	-40°C to 85°C
Storage temperature	-40°C to 155°C
Humidity	98%, +40°C
Vibration resistance	10Hz to 55Hz 1.5mm DA
Shock resistance	98m/s ² (10g)
Termination	PCB ⁴⁾
Construction	Wash tight
Unit weight	Approx. 6g

- 1) Equivalent to the max. initial contact resistance is 100mΩ (at 1A 6VDC).
- 2) 25°C, measured when coil is energized with 100% nominal voltage.
- 3) The value is measured when voltage drops suddenly from nominal voltage to 0 VDC and coil is not paralleled with suppression circuit.
- 4) Since it is an environmental friendly product, please select lead-free solder when welding. The recommended soldering temperature and time is 240°C to 260°C, 2s to 5s.

CONTACT DATA ⁴⁾

at 23°C

Load voltage	Load type		Load current A	On/Off ratio		Electrical endurance OPS	Contact material ¹⁾	Load wiring diagram ³⁾
			1 U	On s	Off s			
13.5VDC	Resistive	Make	2×6	2	2	2×10 ⁵	AgSnO ₂ AgNi0.15	See diagram 1
		Break	2×6	2	2			
	Lamp ²⁾		(2×21W+1×5W)×2	0.2	3	1×10 ⁵	AgSnO ₂	See diagram 2
	Lamp ²⁾		(2×21W)×2	1	14	1×10 ⁵	AgSnO ₂	See diagram 2



HONGFA RELAY

ISO9001、ISO/TS16949、ISO14001、OHSAS18001 CERTIFIED

2007 Rev. 1.00

- 1) AgSnO₂ contact is suitable for the lamp load, inductive load and motor load, while AgNi contact is suitable for resistive load.
- 2) When it is utilized in flasher, a special AgSnO₂ contact material should be used and the customer special code should be (170) as a suffix. Please connect by the polarity according to the diagram below.
- 3) The load wiring diagrams are listed below:

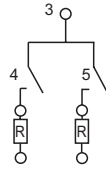

diagram 1

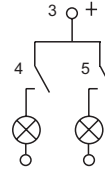

diagram 2

- 4) When the load requirement is different from content of the table above, please contact Hongfa for relay application support.

COIL DATA

at 23°C

Nominal voltage VDC	Pick-up voltage VDC		Drop-out voltage VDC	Coil resistance x(±10%)Ω	Power consumption W
	23°C	85°C			
6	3.5	4.5	0.5	36	1
9	5.2	6.8	0.7	81	1
10	5.8	7.9	0.8	100	1
12	6.9	9.0	1.0	144	1
24	14	18.0	1.9	576	1

ORDERING INFORMATION

	HFKW	/	012	SH	W	(XXX)
Type						
Coil voltage	006: 6VDC	009: 9VDC	010: 10VDC	012: 12VDC	024: 24VDC	
Contact arrangement	SH: 1 Form U (Double NO contacts)					
Contact material	W: AgSnO ₂		N: AgNi0.15			
Customer special code	1) e.g. (170) stands for flasher load, (555) stands for RoHS & ELV compliant. In case there are multiple special requirements, all special codes should be followed one by one.					

- 1) HFKW-SH is an environmental friendly product, please mark special code (555) when order.

OUTLINE DIMENSIONS, WIRING DIAGRAM AND PC BOARD LAYOUT

Unit: mm

Outline Dimensions

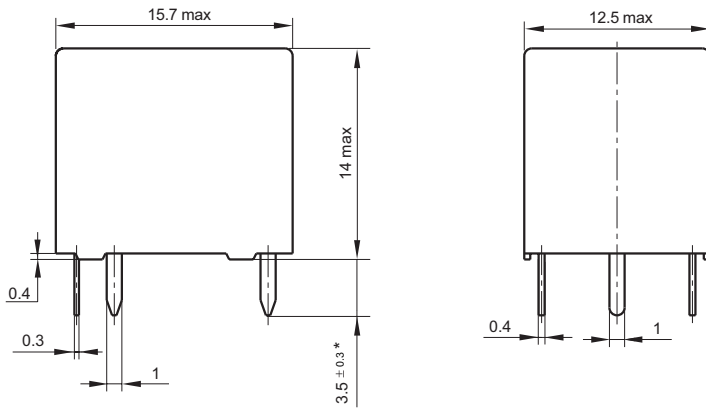

PCB Layout
(Bottom view)

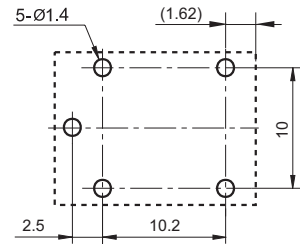

Wiring Diagram
(Bottom view)

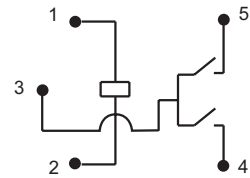

- Notes:**
- 1) * The additional tin top is max. 1mm;
 - 2) The terminal vertical deviation tolerance is 0.2mm;
 - 3) In case of no tolerance shown in outline dimension:
outline dimension ≤ 1 mm, tolerance should be ± 0.2 mm,
outline dimension > 1 mm and ≤ 5 mm, tolerance should be ± 0.3 mm,
outline dimension > 5 mm, tolerance should be ± 0.4 mm;
 - 4) The tolerance without indicating for PCB layout is always ± 0.1 mm.

CHARACTERISTIC CURVES

1. Coil temperature rise

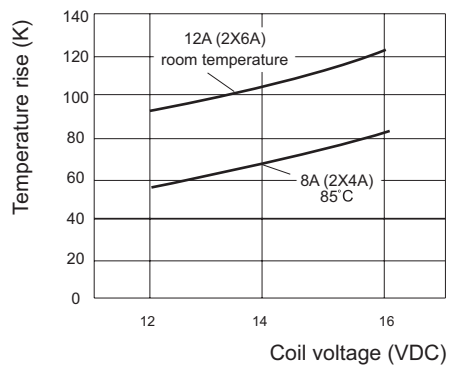

2. Pick-up & drop-out voltage - ambient temperature characteristics

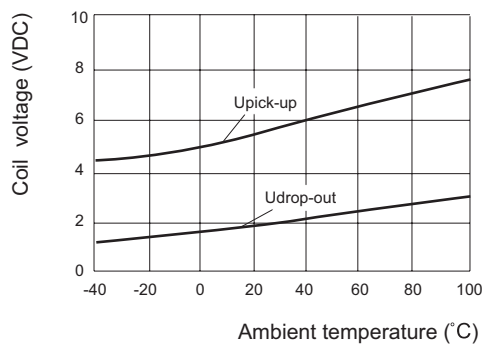

CHARACTERISTIC CURVES

3. Vibration resistance characteristics

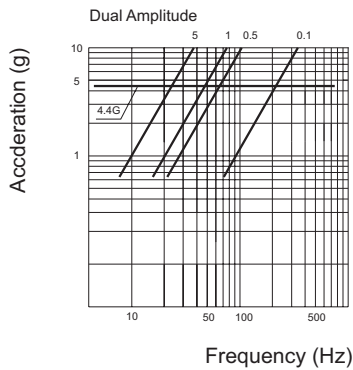

Frequency: 10 to 500 HZ
 Acceleration: 10g max.
 Direction of vibration: See diagram as following
 Detection level: 100 us

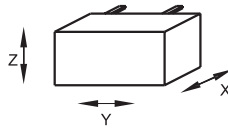

4. Shock resistance characteristics

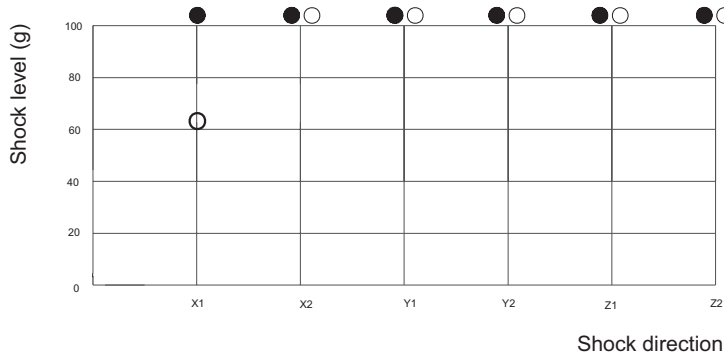

Shock application time: 11 ms
 Test material: coil, energized & de-energized
 Shock direction: See diagram as following
 Detection level: 100 us

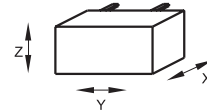

○ : NC Contact
 ● : NO Contact

5. Applied load circuit (for example)

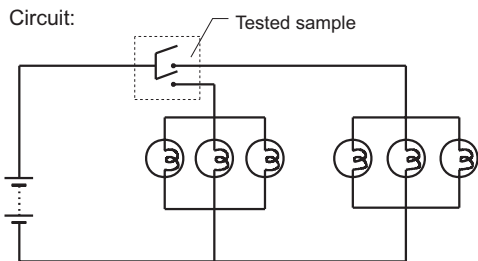

Tested sample: HFKW-012-SHW, 6 PCS
 Load: Lamp, (2 x 21W + 5W) x 2
 Operating frequency: ON 0.3s, OFF 2s

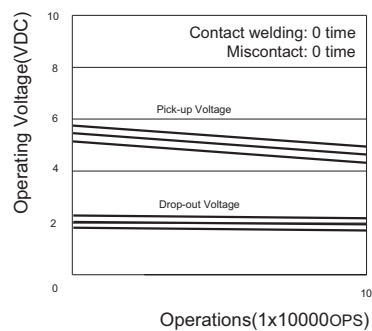

Disclaimer

This datasheet is for the customers' reference. All the specifications are subject to change without notice. We could not evaluate all the performance and all the parameters for every possible application. Thus the user should be in a right position to choose the suitable product for their own application. If there is any query, please contact Hongfa for the technical service. However, it is the user's responsibility to determine which product should be used only.