

# SC Type Fixed Attenuators

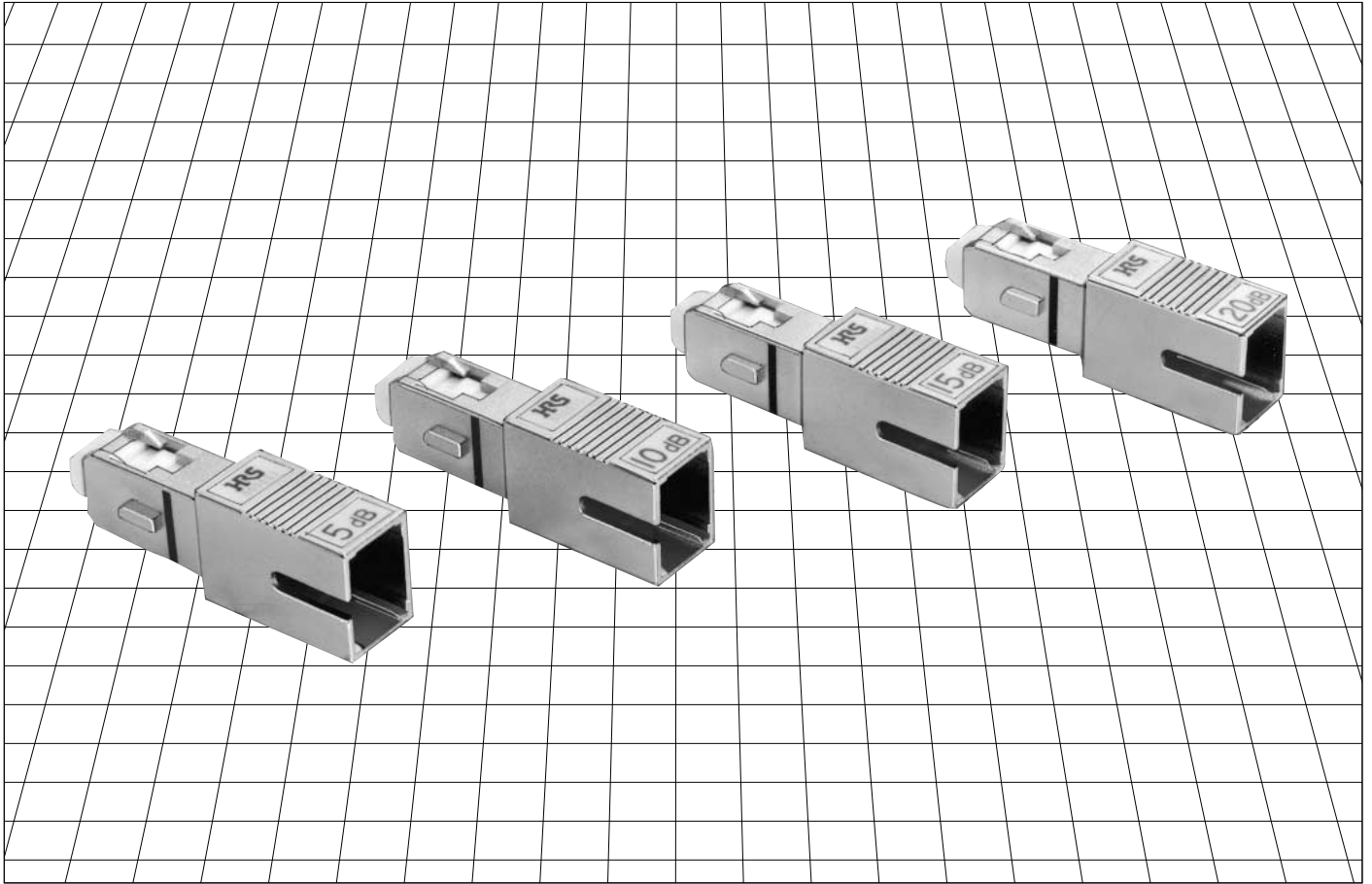

## ■ Features

1. Maximum input power for SM : 250mW
2. Attenuation level : 0,1,2,3,4,5,6,7,8,9,10,11,12,13,14,15,16,20,25,30 dB
3. Dual wavelengths : 1310 nm and 1550 nm
4. User friendly push-pull mechanism
5. Please contact us if you have any requests. Hirose will offer excellent solutions to meet your requirements.

## ■ Applications

Power level adjustment of optical fiber communication networks.

## Product Specifications

### High Power SC-Type Fixed Attenuator (Max. input power: 250mW)

Ratings		Operating temperature range	-40°C to +75°C	Storage temperature range	-40°C to +85°C
		Max. Input Power	250mW	Fiber type	SM
Item		Test Method		Requirements	
Optical Characteristics	Attenuation	Measurement at a point within wavelength of 1310 ± 30 nm and a point within wavelength of 1550 ± 30 nm.		0+0.4db	
				1,2±0.5dB	
				3,4,5,6±0.6dB	
7,8,9,10,11,12,13,14±ATT×10%dB					
15,16,20,25±1.5dB					
	Return Loss			≥40dB	
	Power test	Power : 250mw, Time : 100 hours Laser : LD(wavelength : 1470nm)			Change in attenuation : ±0.2dB
Mechanical Characteristics	Engagement and separation forces	Engagement and separation forces at 50mm/s.		Engagement force: ≤19.6 N Separation force: ≤19.6 N	
	Gauge retention force	Zirconia gauge at φ2.499 ± 0.0005 mm.		2.0N to 3.9N	
	Mating durability	Insertion and extraction number : 500		1) Attenuation and return loss shall be satisfied before and after the test. 2) No breakage, crack or looseness on components.	
	Vibration	3 hours at an amplitude of 1.5mm.with the frequency range 10 to 55Hz. In each of three mutually perpendicular plane.			
	Flex test	8.82N load,100 cycles Telcordia GR-910-CORE			
	Twist test	13.23N load,10 cycles Telcordia GR-910-CORE			
	Side test	12.25N load,90° angle,active Telcordia GR-910-CORE			
	Impact test	3 times in each of three mutually perpendicular axis with the Acceleration 981m/s <sup>2</sup>			
Environmental Characteristics	Composite Temperature-humidity Cyclic test	Humidity : 90% to 96% Temperature : -10°C to 65°C, Time : 480 hours(20 Cyclic)		No significant corrosion.	
	Temperature cycling	Temp : -40→-40→80→80→80 to -40°C Time : 60→ 180 →60→ 180 min Cyclic : 100 cycles			
	Dry heat-high Temperature endurance	Temperature : 85°C	Time : 500 hours		
	Cold	Temperature : -40°C	Time : 500 hours		
	Salt Mist	Salt Mist : 5%	Time : 48 hours		

## Materials

Part	Material
Body	Zinc alloy
Ferrule	Zirconia
Split sleeve	Zirconia

## Ordering Information

**HSC - AT 11 K - A \*\***

①      ②      ③      ④      ⑤      ⑥

① Series name : HSC	④ Polishing code K : AdPC (≥40dB)
② Attenuator	⑤ Optical fiber type A : Single Mode
③ Specification series	⑥ Attenuation : 00,01,02,03,04,05,06,07,08,09, 10,11,12,13,14,15,16,20,25,30

●High Power SC-Type Fixed Attenuator (Max. input power: 250mW)

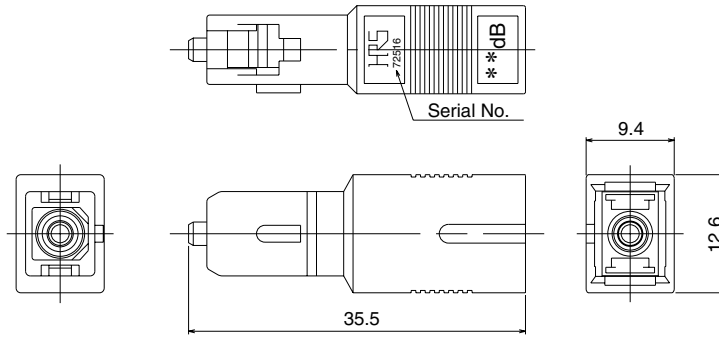
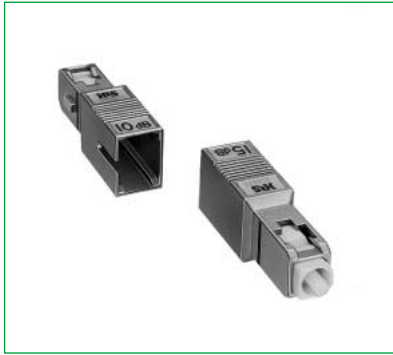

Part Number	CL No.	Attenuation	Attenuation Tolerance	Return Loss	Wavelength	Split Sleeve	Fiber type
HSC-AT11K-A00	820-6001-6	0dB	+0.4dB	≥40dB	1310nm 1550nm	Zirconia	SM
HSC-AT11K-A01	820-6002-9	1dB	±0.5dB				
HSC-AT11K-A02	820-6003-1	2dB	±0.5dB				
HSC-AT11K-A03	820-6004-4	3dB	±0.6dB				
HSC-AT11K-A04	820-6005-7	4dB	±0.6dB				
HSC-AT11K-A05	820-6006-0	5dB	±0.6dB				
HSC-AT11K-A06	820-6007-2	6dB	±0.6dB				
HSC-AT11K-A07	820-6013-5	7dB	±0.7dB				
HSC-AT11K-A08	820-6014-8	8dB	±0.8dB				
HSC-AT11K-A09	820-6015-0	9dB	±0.9dB				
HSC-AT11K-A10	820-6008-5	10dB	±1.0dB				
HSC-AT11K-A11	820-6016-3	11dB	±1.1dB				
HSC-AT11K-A12	820-6017-6	12dB	±1.2dB				
HSC-AT11K-A13	820-6018-9	13dB	±1.3dB				
HSC-AT11K-A14	820-6019-1	14dB	±1.4dB				
HSC-AT11K-A15	820-6009-8	15dB	±1.5dB				
HSC-AT11K-A16	820-6020-0	16dB	±1.5dB				
HSC-AT11K-A20	820-6010-7	20dB	±1.5dB				
HSC-AT11K-A25	820-6011-0	25dB	±1.5dB				
HSC-AT11K-A30	820-6012-2	30dB	±2.5dB				

MU

SC

FC

Harsh Environment

Attenuators

Terminators

**NEW**

# SC-Type Optical Fixed Attenuators

## HSC-AT11U Series

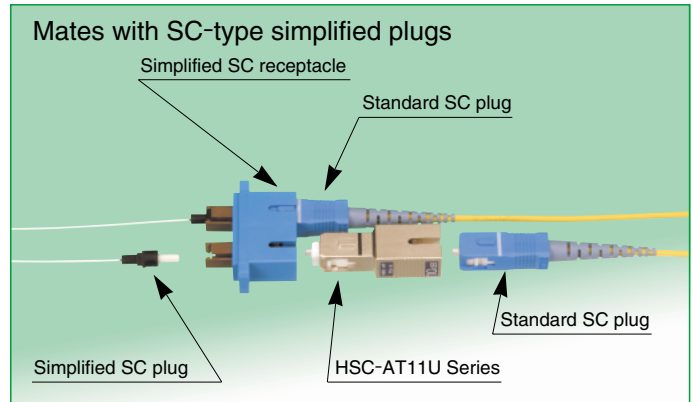
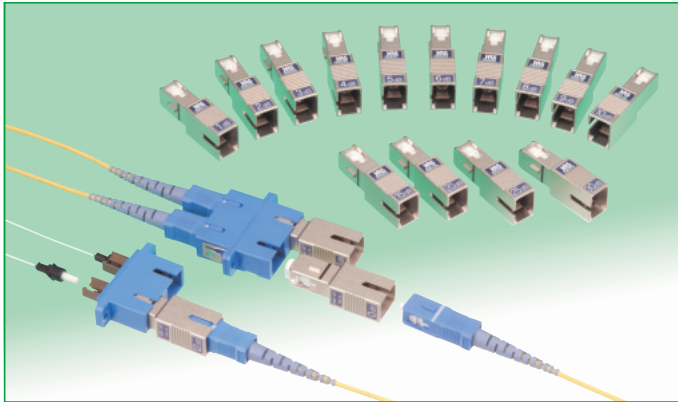

### Features

1. Low return loss, 50 dB min.\*
2. Complies with Telcordia GR-910-CORE.
3. SC-type simplified plugs  
Mates with the spring-less (ferrule-fastened) SC-type simplified plugs.
4. In-line mating with a standard SC connectors
5. High input power (250 mW max.)
6. Variety of fixed attenuation levels.

1 to 16 dB (in 1 dB increments), 20, 25, and 30 dB

### Applications

Optical communication and data transfer equipment requiring in-line fixed power level adjustment.

\* Standard return loss. Contact Hirose Electric sales representative if better return loss is required.

### Return Loss Histogram

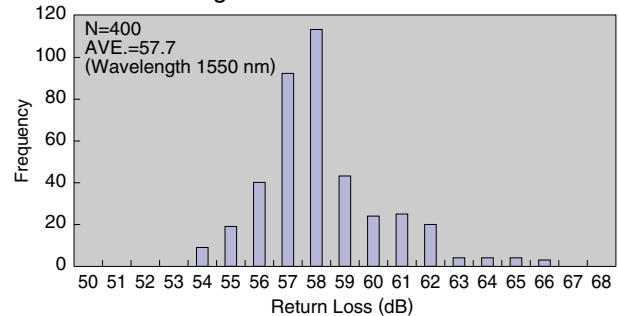

### Ordering Information

## HSC-AT-11-U-A-\*\*-\*\*

① ② ③ ④ ⑤ ⑥

① Series name: HSC	④ Polishing code U: UPC (>=50dB)
② Attenuator	⑤ Optical fiber type A: Single Mode
③ Specification series	⑥ In-line mating with a standard SC connectors :00, 01, 02, 03, 04, 05, 06, 07, 08, 09, 10, 11, 12, 13, 14, 15, 16, 20, 25, 30

Part Number	CL No.	Attenuation	Attenuation Tolerance	Return Loss	Wavelength	Split Sleeve	Fiber Type
HSC-AT11U-A00	820-9500-2	0dB	+0.4dB	≥50dB	1310nm 1550nm	Zirconia	SM
HSC-AT11U-A01	820-9501-5	1dB	±0.5dB				
HSC-AT11U-A02	820-9502-8	2dB	±0.5dB				
HSC-AT11U-A03	820-9503-0	3dB	±0.6dB				
HSC-AT11U-A04	820-9504-3	4dB	±0.6dB				
HSC-AT11U-A05	820-9505-6	5dB	±0.6dB				
HSC-AT11U-A06	820-9506-9	6dB	±0.6dB				
HSC-AT11U-A07	820-9507-1	7dB	±0.7dB				
HSC-AT11U-A08	820-9508-4	8dB	±0.8dB				
HSC-AT11U-A09	820-9509-7	9dB	±0.9dB				
HSC-AT11U-A10	820-9510-6	10dB	±1.0dB				
HSC-AT11U-A11	820-9511-9	11dB	±1.1dB				
HSC-AT11U-A12	820-9512-1	12dB	±1.2dB				
HSC-AT11U-A13	820-9513-4	13dB	±1.3dB				
HSC-AT11U-A14	820-9514-7	14dB	±1.4dB				
HSC-AT11U-A15	820-9515-0	15dB	±1.5dB				
HSC-AT11U-A16	820-9516-2	16dB	±1.5dB				
HSC-AT11U-A20	820-9517-5	20dB	±1.5dB				
HSC-AT11U-A25	820-9518-8	25dB	±1.5dB				
HSC-AT11U-A30	820-9519-0	30dB	±2.5dB				

## Specifications

Rating	Operating temperature range	-40°C to +75°C	Max. input power	250 mW
	Storage temperature range	-40°C to +75°C	Fiber type	SMF

Characteristic	Test Method (Conforms with Telcordia GR-910-CORE)	Specification
Optical characteristic	Attenuation	Measurement at a point within the wavelength of 1310 ±30 nm and a point within the wavelength of 1550 ±30 nm.
	Return loss	
Optical characteristic	Rated input power	Power : 250mW(LD) Wavelength : 1470nm Duration : 100 hours
	Controlled Operating Environment	Temperature : -5°C to 50°C Duration : 182.5 hours Humidity : 15% to 90%
Environmental characteristic	Uncontrolled Operating Environment	Temperature : -40°C to 75°C Period of 1 cycle : 8 hours Number of cycles : 21
	Non-Operating Environment	Low-Temperature Exposure and Thermal Shock Temperature : 23°C → 40°C → -40°C → 23°C Duration : 2.1h 72 h 4 min. minimum
		High-Temperature Exposure and Thermal Shock Temperature : 23°C → 70°C → 70°C → 23°C Duration : 1.6h 72 h 5 min. minimum
		High Relative Humidity Exposure Temperature : 23°C → 40°C → 40°C → 23°C Duration : 0.6h 96 h 0.6h Humidity : 90% to 95%
	Humidity/Condensation Cycling Test	Temperature : -10°C to 65°C Period of 1 cycle : 12 hours Humidity : 90% to 100% Number of cycles : 14
Water Immersion	Temperature : 43°C Duration : 168 hours Solution : PH 5.5	
Mechanical characteristics	Vibration	Vibration frequency range : 10 to 55 Hz Maximum amplitude: 1.52 mm Duration : 2 hours in each of 3 directions
	Side Pull Load	Bend angle : 90° Load : 1.25 kg
	Cable Retention	Load : 2 kg
	Durability	Insertion/withdrawal cycles : 200
	Impact Test	Drop onto a concrete floor from a height of 1.8 m. Cycles: 8 times in each of 3 directions

- 1) After test, change in attenuation(fluctuation)and return loss shall be as follows.  
 1, 2, and 3 dB : within (Nominal attenuation value x0.15) dB  
 Other attenuations : within 0.5 dB  
 · Return loss : 50 dB min.  
 2) No breakage, crack or dislocation of components.

- 1) After /during test, change in attenuation(fluctuation)and return loss shall be as follows.  
 1, 2, and 3 dB : within (Nominal attenuation value x0.15) dB  
 Other attenuations : within 0.5 dB  
 · Return loss : 50 dB min.  
 2) No breakage, crack or dislocation of components.

- 1) After test, change in attenuation(fluctuation)and return loss shall be as follows.  
 1, 2, and 3 dB : within (Nominal attenuation value x0.15) dB  
 Other attenuations : within 0.5 dB  
 · Return loss : 50 dB min.  
 2) No breakage, crack or dislocation of components.

## Materials and Dimensions

Component	Material
Body	Zinc alloy
Ferrule	Zirconia
Split sleeve	Zirconia

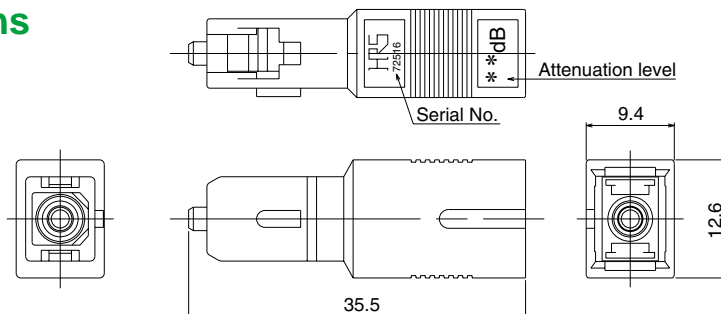

## HIROSE ELECTRIC CO.,LTD.

5-23,OSAKI 5-CHOME,SHINAGAWA-KU,TOKYO 141-8587,JAPAN  
 PHONE: 81-3-3491-9741, FAX: 81-3-3493-2933  
<http://www.hirose.com>  
<http://www.hirose-connectors.com>