

PDP TRENCH IGBT

IRGI4085PbF

Features

- Advanced Trench IGBT Technology
- Optimized for Sustain and Energy Recovery circuits in PDP applications
- Low $V_{CE(on)}$ and Energy per Pulse (E_{PULSE}^{TM}) for improved panel efficiency
- High repetitive peak current capability
- Lead Free package

Key Parameters		
$V_{CE\ min}$	330	V
$V_{CE(on)}\ typ.\ @\ I_C = 28A$	1.21	V
$I_{RP}\ max\ @\ T_C = 25^\circ C$	210	A
$T_J\ max$	150	$^\circ C$

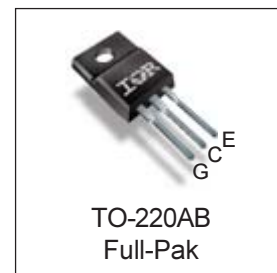
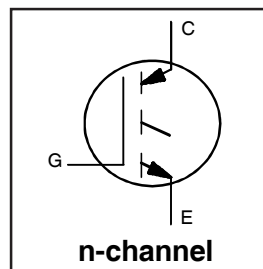

G	C	E
Gate	Collector	Emitter

Description

This IGBT is specifically designed for applications in Plasma Display Panels. This device utilizes advanced trench IGBT technology to achieve low $V_{CE(on)}$ and low E_{PULSE}^{TM} rating per silicon area which improve panel efficiency. Additional features are 150 $^\circ C$ operating junction temperature and high repetitive peak current capability. These features combine to make this IGBT a highly efficient, robust and reliable device for PDP applications.

Absolute Maximum Ratings

	Parameter	Max.	Units
V_{GE}	Gate-to-Emitter Voltage	± 30	V
$I_C @ T_C = 25^\circ C$	Continuous Collector Current, $V_{GE} @ 15V$	28	A
$I_C @ T_C = 100^\circ C$	Continuous Collector, $V_{GE} @ 15V$	15	
$I_{RP} @ T_C = 25^\circ C$	Repetitive Peak Current ①	210	
$P_D @ T_C = 25^\circ C$	Power Dissipation	38	W
$P_D @ T_C = 100^\circ C$	Power Dissipation	15	
	Linear Derating Factor	0.30	W/ $^\circ C$
T_J	Operating Junction and	-40 to + 150	$^\circ C$
T_{STG}	Storage Temperature Range		
	Soldering Temperature for 10 seconds	300	
	Mounting Torque, 6-32 or M3 Screw	10lb·in (1.1N·m)	N

Thermal Resistance

	Parameter	Typ.	Max.	Units
$R_{\theta JC}$	Junction-to-Case ②	—	3.29	$^\circ C/W$

Electrical Characteristics @ $T_J = 25^\circ\text{C}$ (unless otherwise specified)

	Parameter	Min.	Typ.	Max.	Units	Conditions
BV_{CES}	Collector-to-Emitter Breakdown Voltage	330	—	—	V	$V_{GE} = 0V, I_{CE} = 1\text{ mA}$
$V_{(BR)ECS}$	Emitter-to-Collector Breakdown Voltage ^③	30	—	—	V	$V_{GE} = 0V, I_{CE} = 1\text{ A}$
$\Delta BV_{CES}/\Delta T_J$	Breakdown Voltage Temp. Coefficient	—	0.31	—	V/ $^\circ\text{C}$	Reference to 25°C , $I_{CE} = 1\text{ mA}$
$V_{CE(on)}$	Static Collector-to-Emitter Voltage	—	1.05	—	V	$V_{GE} = 15V, I_{CE} = 15A$ ^③
		—	1.21	1.50		$V_{GE} = 15V, I_{CE} = 28A$ ^③
		—	1.35	—		$V_{GE} = 15V, I_{CE} = 40A$ ^③
		—	1.68	—		$V_{GE} = 15V, I_{CE} = 70A$ ^③
		—	2.23	—		$V_{GE} = 15V, I_{CE} = 120A$ ^③
		—	1.90	—		$V_{GE} = 15V, I_{CE} = 70A, T_J = 150^\circ\text{C}$ ^③
$V_{GE(th)}$	Gate Threshold Voltage	2.6	—	5.0	V	$V_{CE} = V_{GE}, I_{CE} = 500\mu\text{A}$
$\Delta V_{GE(th)}/\Delta T_J$	Gate Threshold Voltage Coefficient	—	-10	—	mV/ $^\circ\text{C}$	
I_{CES}	Collector-to-Emitter Leakage Current	—	2.0	25	μA	$V_{CE} = 330V, V_{GE} = 0V$
		—	5.0	—		$V_{CE} = 330V, V_{GE} = 0V, T_J = 100^\circ\text{C}$
		—	100	—		$V_{CE} = 330V, V_{GE} = 0V, T_J = 150^\circ\text{C}$
I_{GES}	Gate-to-Emitter Forward Leakage	—	—	100	nA	$V_{GE} = 30V$
	Gate-to-Emitter Reverse Leakage	—	—	-100		$V_{GE} = -30V$
g_{fe}	Forward Transconductance	—	51	—	S	$V_{CE} = 25V, I_{CE} = 25A$
Q_g	Total Gate Charge	—	84	—	nC	$V_{CE} = 200V, I_C = 25A, V_{GE} = 15V$ ^③
Q_{gc}	Gate-to-Collector Charge	—	30	—		
$t_{d(on)}$	Turn-On delay time	—	48	—	ns	$I_C = 25A, V_{CC} = 196V$ $R_G = 10\Omega, L = 200\mu\text{H}, L_S = 150\text{nH}$ $T_J = 25^\circ\text{C}$
t_r	Rise time	—	37	—		
$t_{d(off)}$	Turn-Off delay time	—	180	—		
t_f	Fall time	—	102	—		
$t_{d(on)}$	Turn-On delay time	—	45	—	ns	$I_C = 25A, V_{CC} = 196V$ $R_G = 10\Omega, L = 200\mu\text{H}, L_S = 150\text{nH}$ $T_J = 150^\circ\text{C}$
t_r	Rise time	—	38	—		
$t_{d(off)}$	Turn-Off delay time	—	234	—		
t_f	Fall time	—	185	—		
t_{st}	Shoot Through Blocking Time	100	—	—	ns	$V_{CC} = 240V, V_{GE} = 15V, R_G = 5.1\Omega$
E_{PULSE}	Energy per Pulse	—	854	—	μJ	$L = 220\text{nH}, C = 0.40\mu\text{F}, V_{GE} = 15V$ $V_{CC} = 240V, R_G = 5.1\Omega, T_J = 25^\circ\text{C}$
		—	977	—		$L = 220\text{nH}, C = 0.40\mu\text{F}, V_{GE} = 15V$ $V_{CC} = 240V, R_G = 5.1\Omega, T_J = 100^\circ\text{C}$
C_{ies}	Input Capacitance	—	2287	—	pF	$V_{GE} = 0V$
C_{oes}	Output Capacitance	—	141	—		$V_{CE} = 30V$
C_{res}	Reverse Transfer Capacitance	—	73	—		$f = 1.0\text{MHz}$, See Fig.13
L_C	Internal Collector Inductance	—	5.0	—	nH	Between lead, 6mm (0.25in.) from package and center of die contact
L_E	Internal Emitter Inductance	—	13	—		

Notes:

- ① Half sine wave with duty cycle = 0.10, $t_{on} = 2\mu\text{sec}$.
- ② R_{θ} is measured at T_J of approximately 90°C .
- ③ Pulse width $\leq 400\mu\text{s}$; duty cycle $\leq 2\%$.

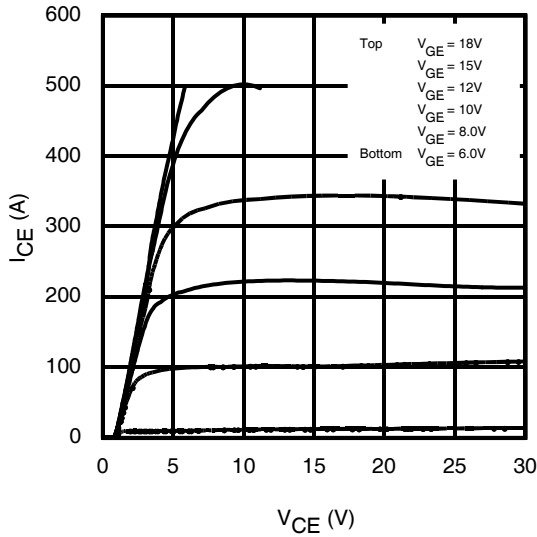

Fig 1. Typical Output Characteristics @ 25°C

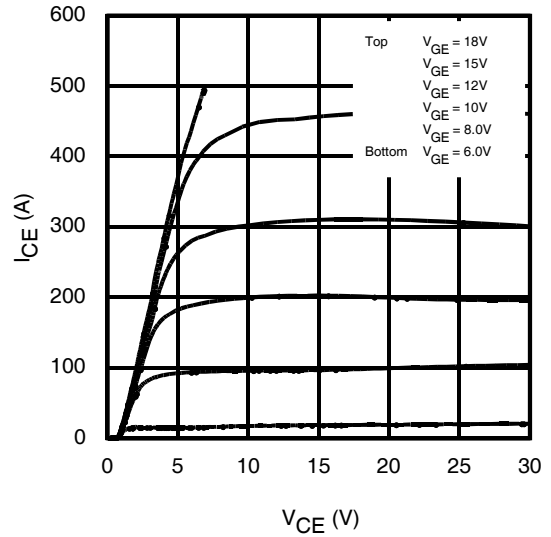

Fig 2. Typical Output Characteristics @ 75°C

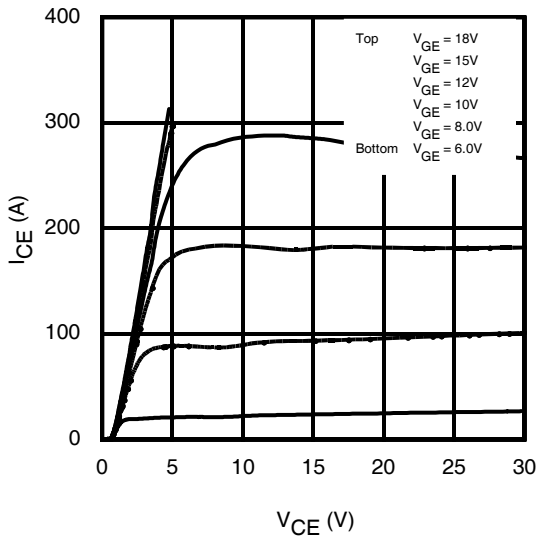

Fig 3. Typical Output Characteristics @ 125°C

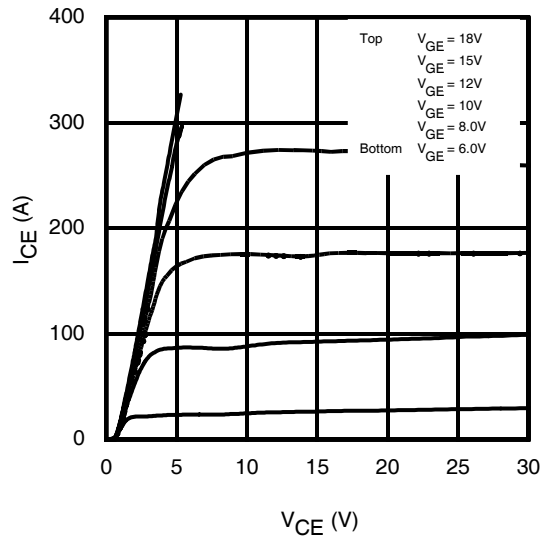

Fig 4. Typical Output Characteristics @ 150°C

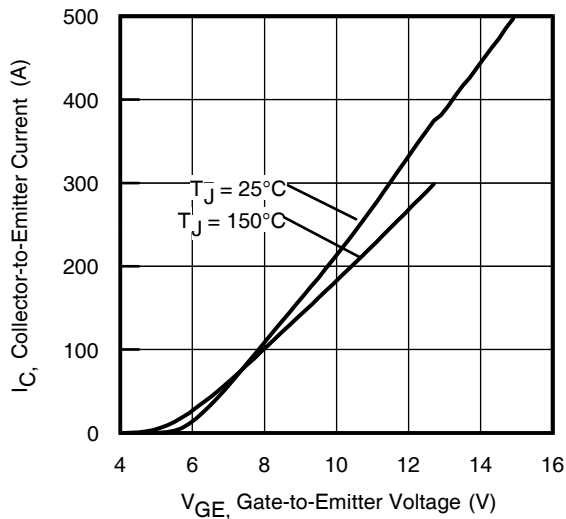

Fig 5. Typical Transfer Characteristics

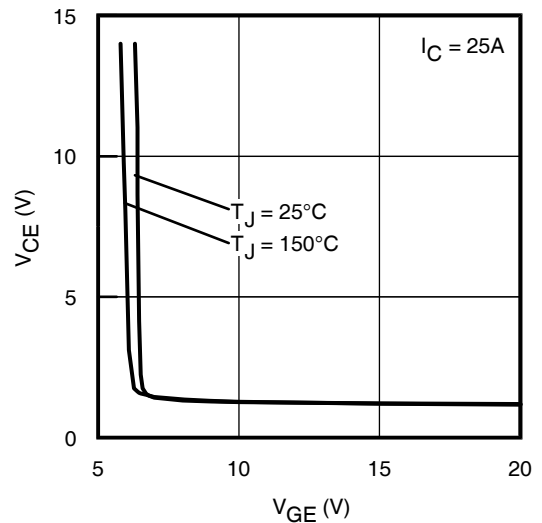

Fig 6. $V_{CE(ON)}$ vs. Gate Voltage

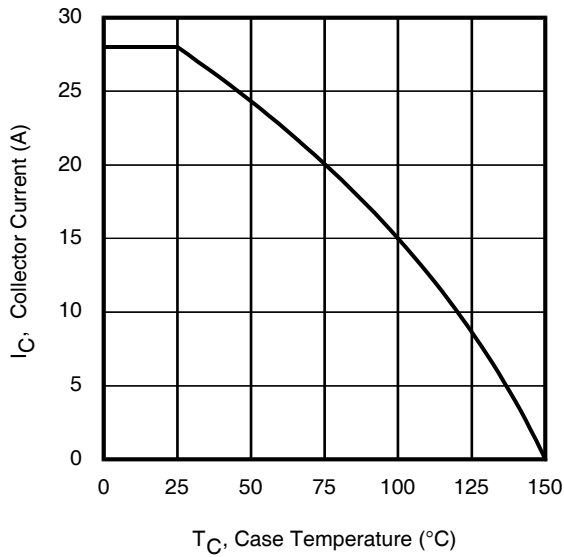

Fig 7. Maximum Collector Current vs. Case Temperature

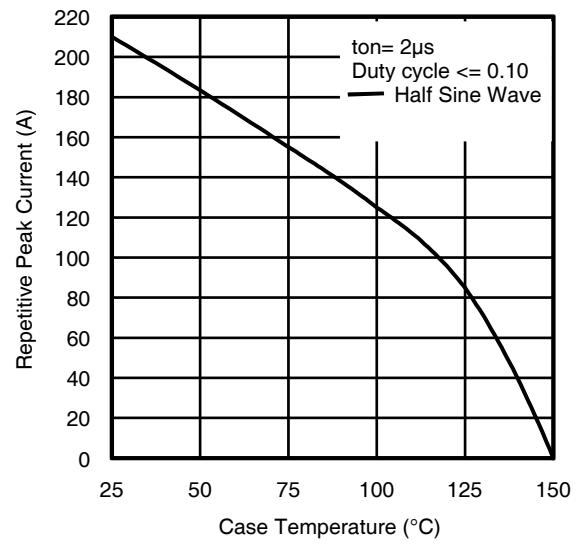

Fig 8. Typical Repetitive Peak Current vs. Case Temperature

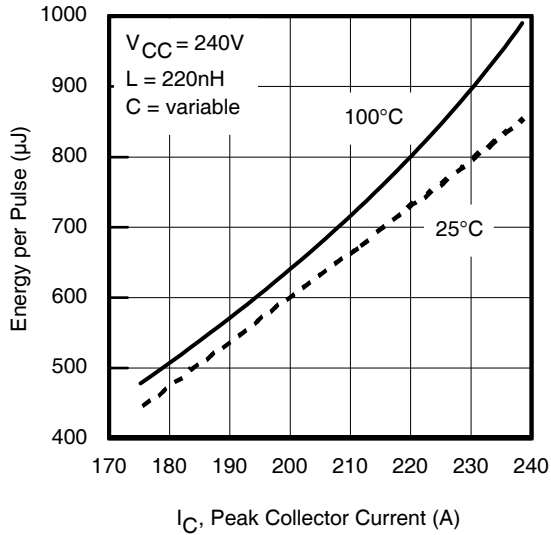

Fig 9. Typical E_{PULSE} vs. Collector Current

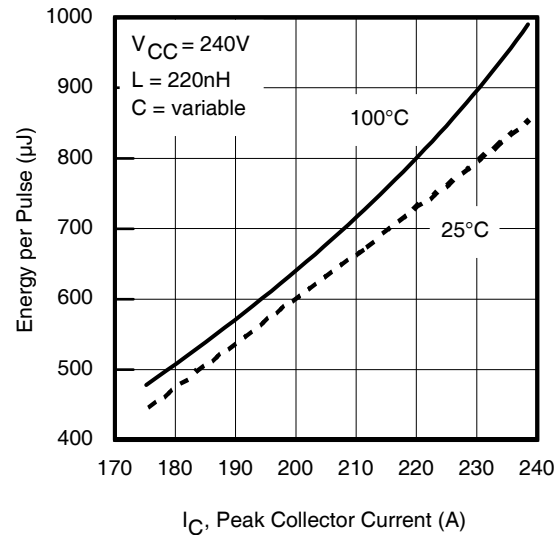

Fig 10. Typical E_{PULSE} vs. Collector-to-Emitter Voltage

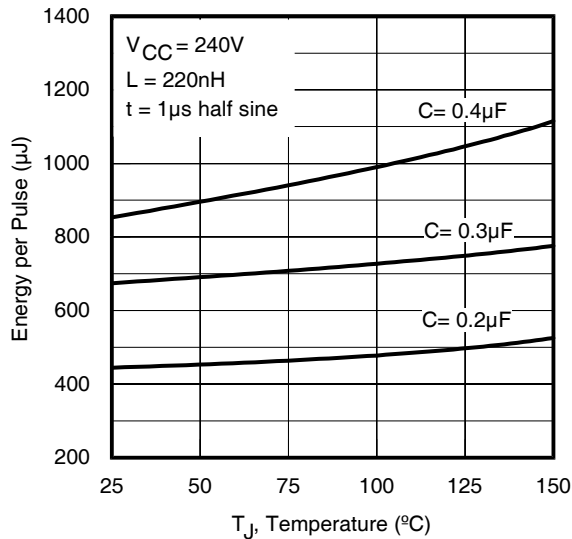

Fig 11. E_{PULSE} vs. Temperature

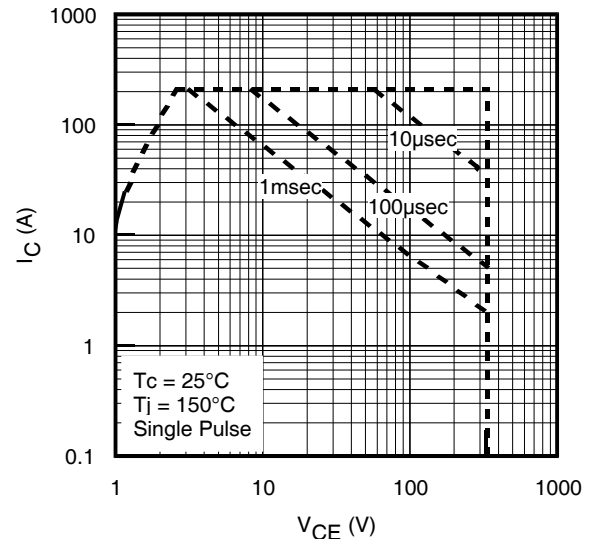

Fig 12. Forward Bias Safe Operating Area

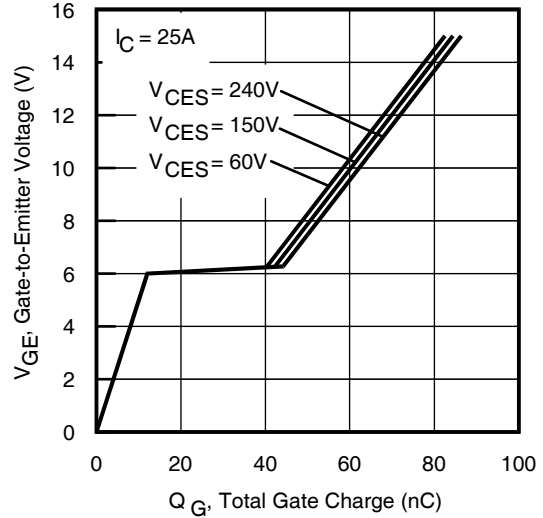
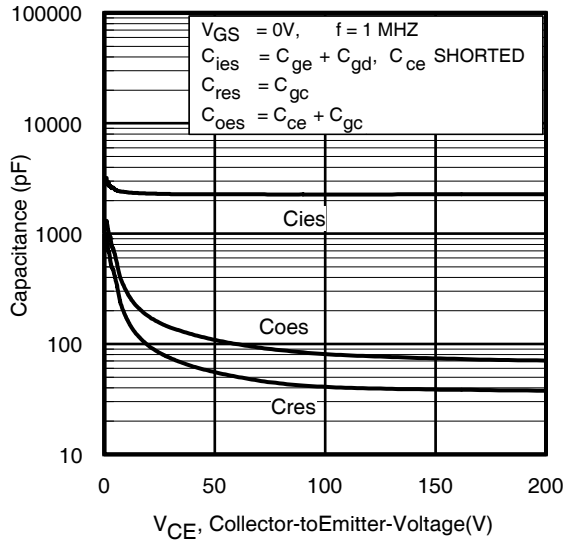

Fig 13. Typical Capacitance vs. Collector-to-Emitter Voltage

Fig 14. Typical Gate Charge vs. Gate-to-Emitter Voltage

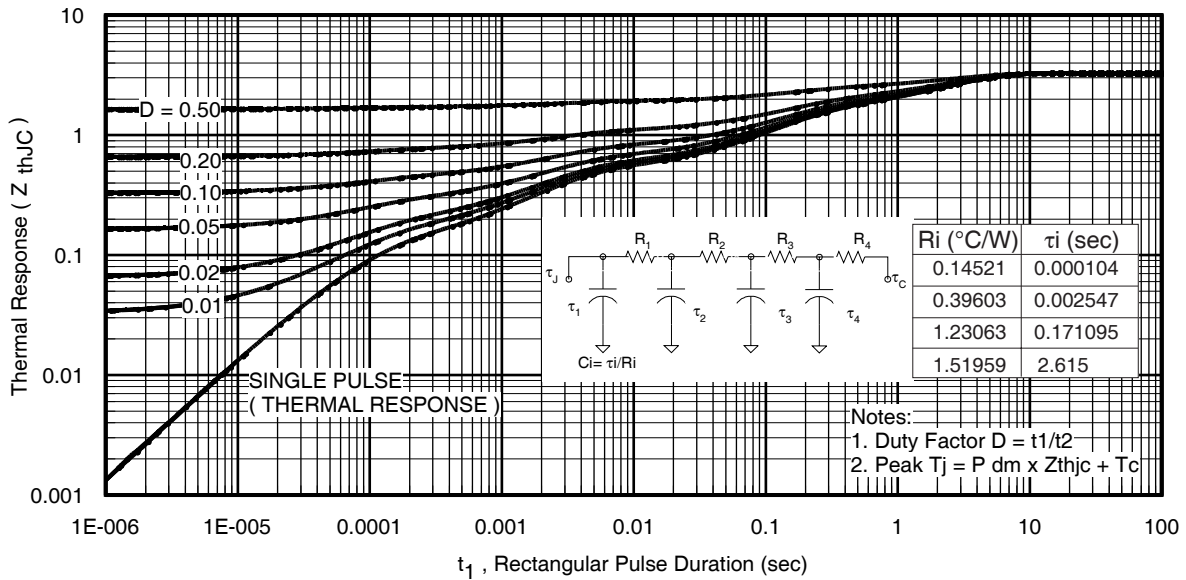

Fig 15. Maximum Effective Transient Thermal Impedance, Junction-to-Case

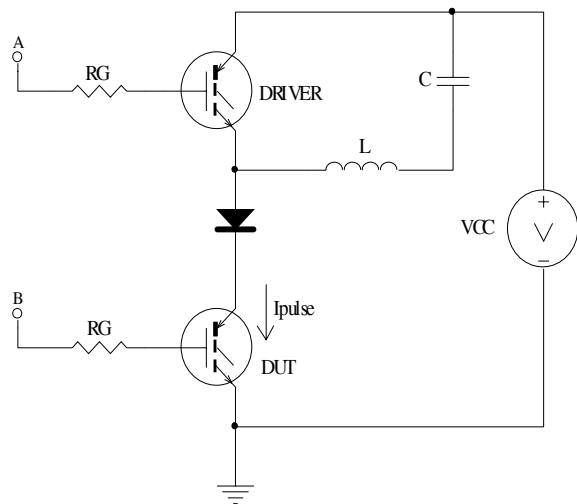

Fig 16a. t_{st} and E_{PULSE} Test Circuit

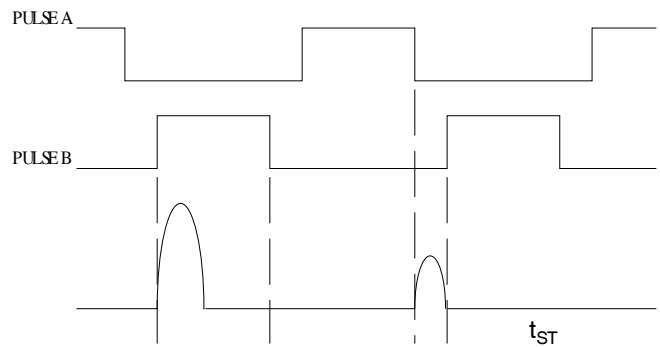

Fig 16b. t_{st} Test Waveforms

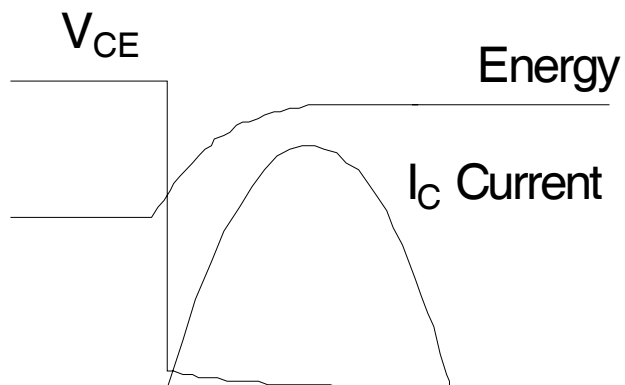

Fig 16c. E_{PULSE} Test Waveforms

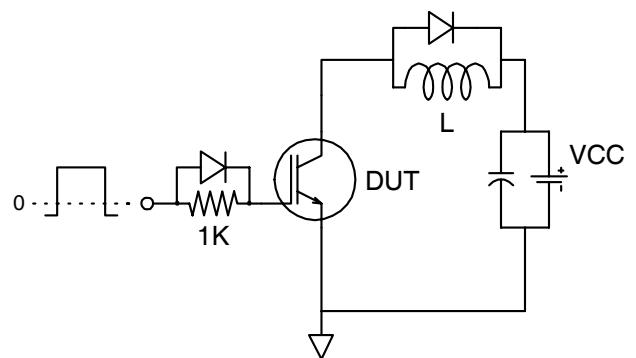
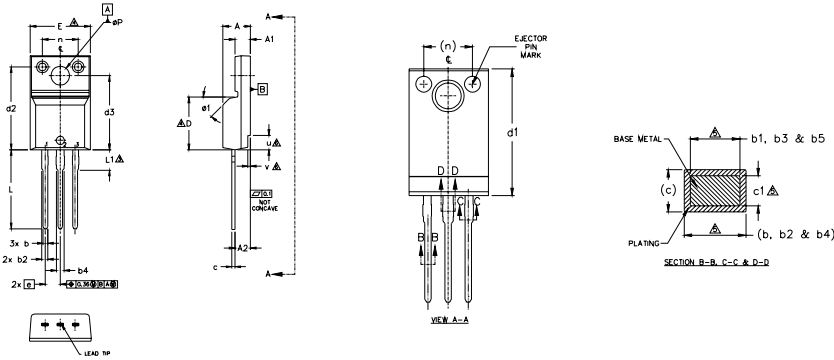

Fig 17 - Gate Charge Circuit (turn-off)

TO-220 Full-Pak Package Outline

Dimensions are shown in millimeters (inches)



SYMBOL	DIMENSIONS				NOTES
	MILLIMETERS		INCHES		
	MIN.	MAX.	MIN.	MAX.	
A	4.57	4.83	.180	.190	
A1	2.57	2.83	.101	.111	
A2	2.51	2.93	.099	.115	
b	0.61	0.94	.024	.037	
b1	0.61	0.89	.024	.035	
b2	0.76	1.27	.030	.050	
b3	0.76	1.22	.030	.048	
b4	1.02	1.52	.040	.060	
b5	1.02	1.47	.040	.058	
c	0.33	0.63	.013	.025	
c1	0.33	0.58	.013	.023	
D	8.66	9.80	.341	.386	
d1	15.80	16.13	.622	.635	
d2	13.97	14.22	.550	.560	
d3	12.30	12.93	.484	.509	
E	9.63	10.75	.379	.423	
e	2.54	BSC	.100	BSC	
L	13.20	13.72	.520	.540	3
L1	3.37	3.67	.122	.145	
L2	3.37	3.67	.122	.145	
n	6.05	6.60	.238	.260	6
φP	3.05	3.45	.120	.136	
u	2.40	2.50	.094	.098	
v	0.40	0.50	.016	.020	6
φ1	-	45°	-	45°	

NOTES:
 1.0 DIMENSIONING AND TOLERANCING AS PER ASME Y14.5 M- 1994.
 2.0 DIMENSIONS ARE SHOWN IN MILLIMETERS [INCHES].
 3.0 LEAD DIMENSION AND FINISH UNCONTROLLED IN L1.
 4.0 DIMENSION D & E DO NOT INCLUDE MOLD FLASH. MOLD FLASH SHALL NOT EXCEED .005" (0.127) PER SIDE. THESE DIMENSIONS ARE MEASURED AT THE OUTER MOST EXTREMES OF THE PLASTIC BODY.
 5.0 DIMENSION b1, b3, b5 & c1 APPLY TO BASE METAL ONLY.
 6.0 STEP OPTIONAL ON PLASTIC BODY DEFINED BY DIMENSIONS u & v.
 7.0 CONTROLLING DIMENSION : INCHES.

LEAD ASSIGNMENTS

HEXFET
 1.- GATE
 2.- DRAIN
 3.- SOURCE

IGBTs, CoPACK
 1.- GATE
 2.- COLLECTOR
 3.- EMITTER

TO-220 Full-Pak Part Marking Information

EXAMPLE: THIS IS AN IRFI840G
 WITH ASSEMBLY
 LOT CODE 3432
 ASSEMBLED ON WW 24, 2001
 IN THE ASSEMBLY LINE 'K'

Note: 'P' in assembly line position indicates 'Lead-Free'

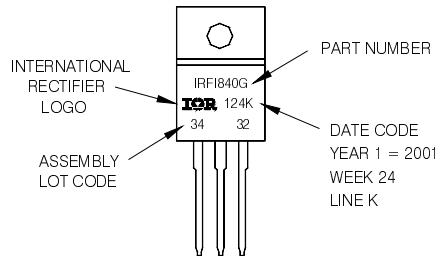

TO-220AB Full-Pak package is not recommended for Surface Mount Application.

The specifications set forth in this data sheet are the sole and exclusive specifications applicable to the identified product, and no specifications or features are implied whether by industry custom, sampling or otherwise. We qualify our products in accordance with our internal practices and procedures, which by their nature do not include qualification to all possible or even all widely used applications. Without limitation, we have not qualified our product for medical use or applications involving hi-reliability applications. Customers are encouraged to and responsible for qualifying product to their own use and their own application environments, especially where particular features are critical to operational performance or safety. Please contact your IR representative if you have specific design or use requirements or for further information.

Data and specifications subject to change without notice. This product has been designed for the Industrial market. Qualification Standards can be found on IR's Web site.