

# IRLIB9343

## Features

- Advanced Process Technology
- Key Parameters Optimized for Class-D Audio Amplifier Applications
- Low  $R_{DS(ON)}$  for Improved Efficiency
- Low  $Q_g$  and  $Q_{sw}$  for Better THD and Improved Efficiency
- Low  $Q_{rr}$  for Better THD and Lower EMI
- 175°C Operating Junction Temperature for Ruggedness
- Repetitive Avalanche Capability for Robustness and Reliability

Key Parameters		
$V_{DS}$	-55	V
$R_{DS(ON)}$ typ. @ $V_{GS} = -10V$	93	m $\Omega$
$R_{DS(ON)}$ typ. @ $V_{GS} = -4.5V$	150	m $\Omega$
$Q_g$ typ.	31	nC
$T_J$ max	175	°C

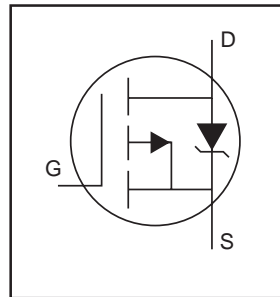

## Description

This Digital Audio HEXFET<sup>®</sup> is specifically designed for Class-D audio amplifier applications. This MosFET utilizes the latest processing techniques to achieve low on-resistance per silicon area. Furthermore, Gate charge, body-diode reverse recovery and internal Gate resistance are optimized to improve key Class-D audio amplifier performance factors such as efficiency, THD and EMI. Additional features of this MosFET are 175°C operating junction temperature and repetitive avalanche capability. These features combine to make this MosFET a highly efficient, robust and reliable device for Class-D audio amplifier applications.

## Absolute Maximum Ratings

	Parameter	Max.	Units
$V_{DS}$	Drain-to-Source Voltage	-55	V
$V_{GS}$	Gate-to-Source Voltage	$\pm 20$	
$I_D$ @ $T_C = 25^\circ C$	Continuous Drain Current, $V_{GS}$ @ -10V	-14	A
$I_D$ @ $T_C = 100^\circ C$	Continuous Drain Current, $V_{GS}$ @ -10V	-10	
$I_{DM}$	Pulsed Drain Current ①	-60	
$P_D$ @ $T_C = 25^\circ C$	Power Dissipation	33	W
$P_D$ @ $T_C = 100^\circ C$	Power Dissipation	20	
	Linear Derating Factor	0.26	W/°C
$T_J$	Operating Junction and	-40 to + 175	°C
$T_{STG}$	Storage Temperature Range		
	Mounting Torque, 6-32 or M3 screw	10 (1.1)	lbf·in (N·m)

## Thermal Resistance

	Parameter	Typ.	Max.	Units
$R_{\theta JC}$	Junction-to-Case ④	—	3.84	°C/W
$R_{\theta JA}$	Junction-to-Ambient ④	—	65	

Notes ① through ⑤ are on page 7

**Electrical Characteristics @  $T_J = 25^\circ\text{C}$  (unless otherwise specified)**

	Parameter	Min.	Typ.	Max.	Units	Conditions
$BV_{DSS}$	Drain-to-Source Breakdown Voltage	-55	—	—	V	$V_{GS} = 0V, I_D = -250\mu A$
$\Delta BV_{DSS}/\Delta T_J$	Breakdown Voltage Temp. Coefficient	—	-52	—	mV/°C	Reference to $25^\circ\text{C}$ , $I_D = -1\text{mA}$
$R_{DS(on)}$	Static Drain-to-Source On-Resistance	—	93	105	m $\Omega$	$V_{GS} = -10V, I_D = -3.4A$ ③
		—	150	170		$V_{GS} = -4.5V, I_D = -2.7A$ ③
$V_{GS(th)}$	Gate Threshold Voltage	-1.0	—	—	V	$V_{DS} = V_{GS}, I_D = -250\mu A$
$\Delta V_{GS(th)}/\Delta T_J$	Gate Threshold Voltage Coefficient	—	-3.7	—	mV/°C	
$I_{DSS}$	Drain-to-Source Leakage Current	—	—	-2.0	$\mu A$	$V_{DS} = -55V, V_{GS} = 0V$
		—	—	-25		$V_{DS} = -55V, V_{GS} = 0V, T_J = 125^\circ\text{C}$
$I_{GSS}$	Gate-to-Source Forward Leakage	—	—	-100	nA	$V_{GS} = -20V$
	Gate-to-Source Reverse Leakage	—	—	100		$V_{GS} = 20V$
$g_{fs}$	Forward Transconductance	5.3	—	—	S	$V_{DS} = -25V, I_D = -14A$
$Q_g$	Total Gate Charge	—	31	47		$V_{DS} = -44V$
$Q_{gs}$	Pre-Vth Gate-to-Source Charge	—	7.1	—		$V_{GS} = -10V$
$Q_{gd}$	Gate-to-Drain Charge	—	8.5	—		$I_D = -14A$
$Q_{godr}$	Gate Charge Overdrive	—	15	—		See Fig. 6 and 19
$t_{d(on)}$	Turn-On Delay Time	—	9.5	—	ns	$V_{DD} = -28V, V_{GS} = -10V$ ③
$t_r$	Rise Time	—	24	—		$I_D = -14A$
$t_{d(off)}$	Turn-Off Delay Time	—	21	—		$R_G = 2.5\Omega$
$t_f$	Fall Time	—	9.5	—		
$C_{iss}$	Input Capacitance	—	660	—	pF	$V_{GS} = 0V$
$C_{oss}$	Output Capacitance	—	160	—		$V_{DS} = -50V$
$C_{rss}$	Reverse Transfer Capacitance	—	72	—		$f = 1.0\text{MHz}$ , See Fig.5
$C_{oss}$	Effective Output Capacitance	—	280	—		$V_{GS} = 0V, V_{DS} = 0V$ to $-44V$
$L_D$	Internal Drain Inductance	—	4.5	—	nH	Between lead, 6mm (0.25in.) from package and center of die contact
$L_S$	Internal Source Inductance	—	7.5	—		

**Avalanche Characteristics**

	Parameter	Typ.	Max.	Units
$E_{AS}$	Single Pulse Avalanche Energy②	—	190	mJ
$I_{AR}$	Avalanche Current ⑤	See Fig. 14, 15, 17a, 17b		A
$E_{AR}$	Repetitive Avalanche Energy ⑤			mJ

**Diode Characteristics**

	Parameter	Min.	Typ.	Max.	Units	Conditions
$I_S @ T_C = 25^\circ\text{C}$	Continuous Source Current (Body Diode)	—	—	-14	A	MOSFET symbol showing the integral reverse p-n junction diode.
$I_{SM}$	Pulsed Source Current (Body Diode) ①	—	—	-60		
$V_{SD}$	Diode Forward Voltage	—	—	-1.2	V	$T_J = 25^\circ\text{C}, I_S = -14A, V_{GS} = 0V$ ③
$t_{rr}$	Reverse Recovery Time	—	57	86	ns	$T_J = 25^\circ\text{C}, I_F = -14A$
$Q_{rr}$	Reverse Recovery Charge	—	120	180	nC	$di/dt = 100A/\mu s$ ③

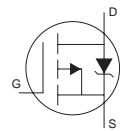

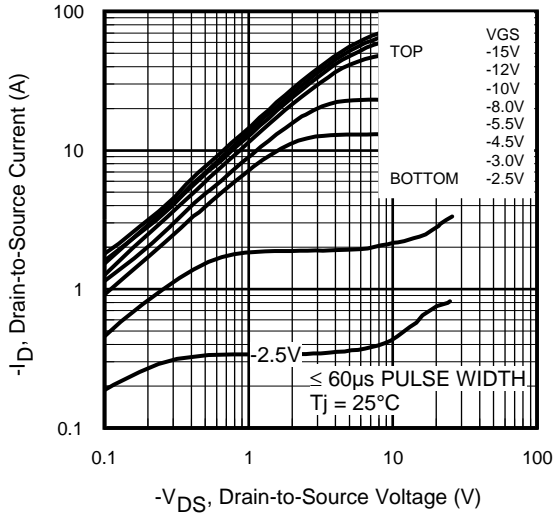

Fig 1. Typical Output Characteristics

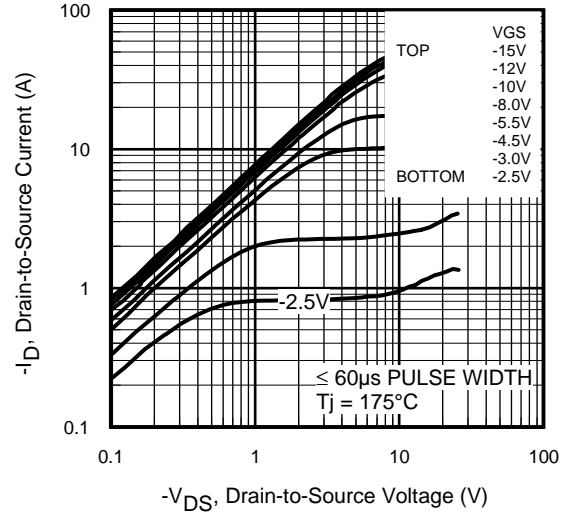

Fig 2. Typical Output Characteristics

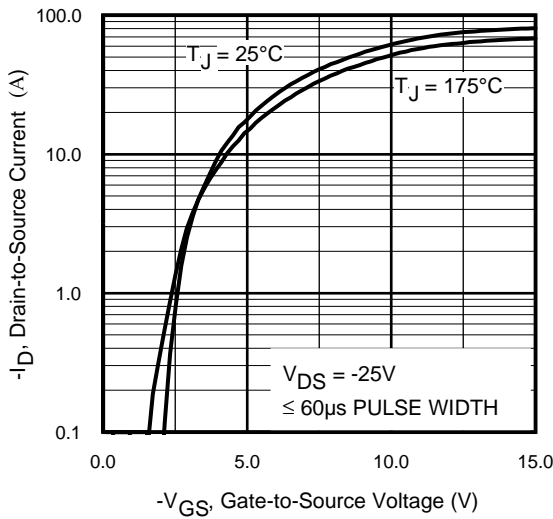

Fig 3. Typical Transfer Characteristics

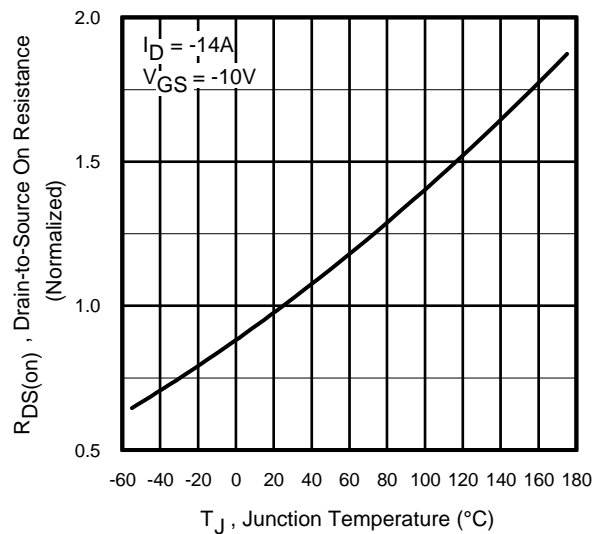

Fig 4. Normalized On-Resistance vs. Temperature

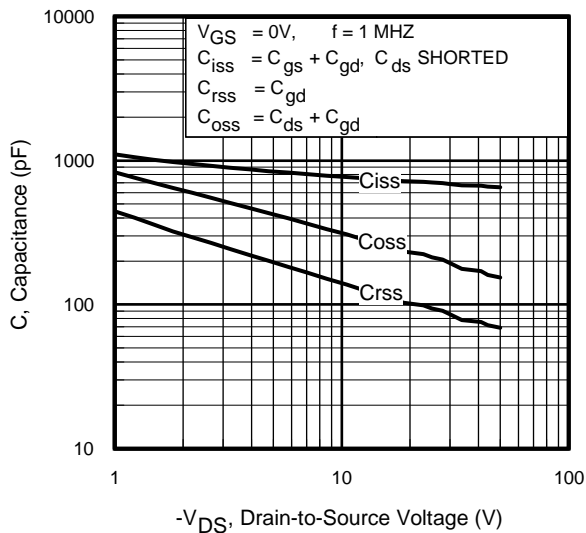

Fig 5. Typical Capacitance vs. Drain-to-Source Voltage  
www.irf.com

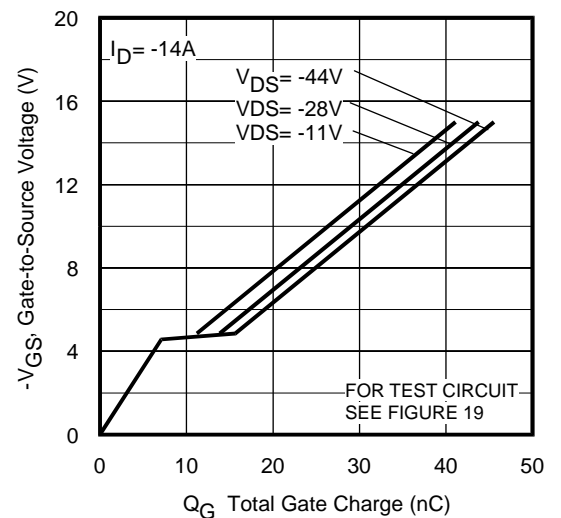
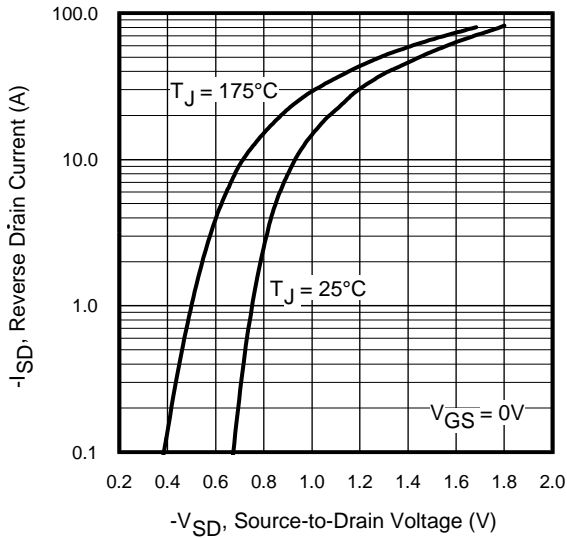
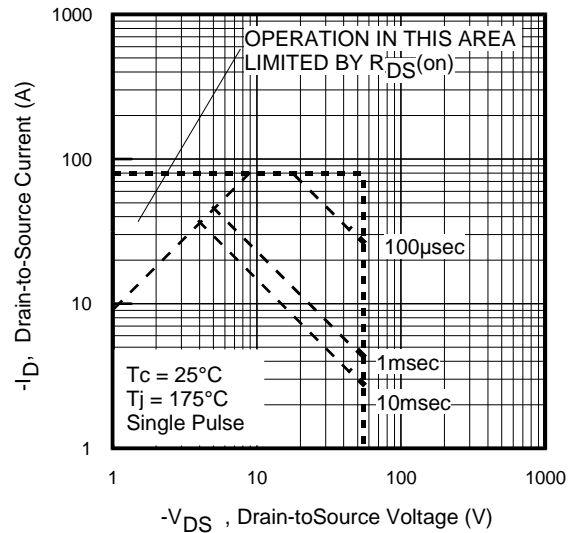

Fig 6. Typical Gate Charge vs. Gate-to-Source Voltage



**Fig 7.** Typical Source-Drain Diode Forward Voltage



**Fig 8.** Maximum Safe Operating Area

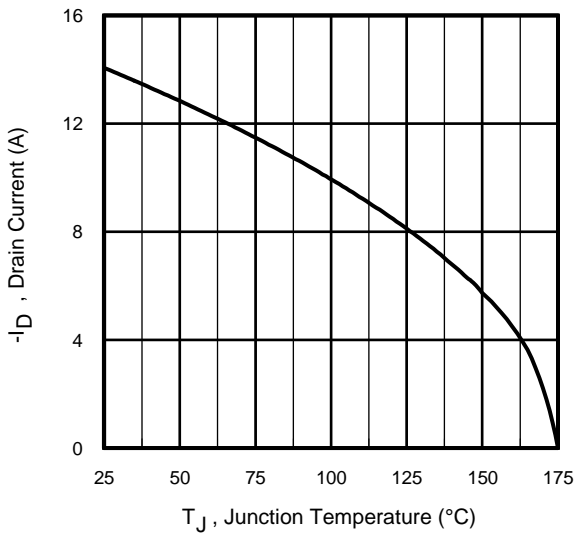

**Fig 9.** Maximum Drain Current vs. Case Temperature

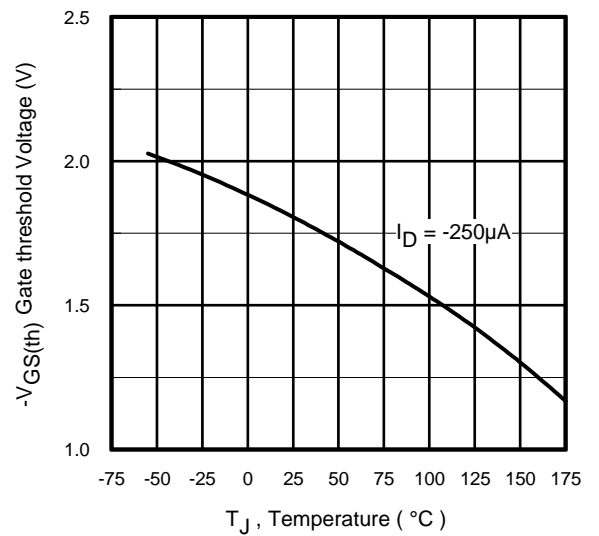

**Fig 10.** Threshold Voltage vs. Temperature

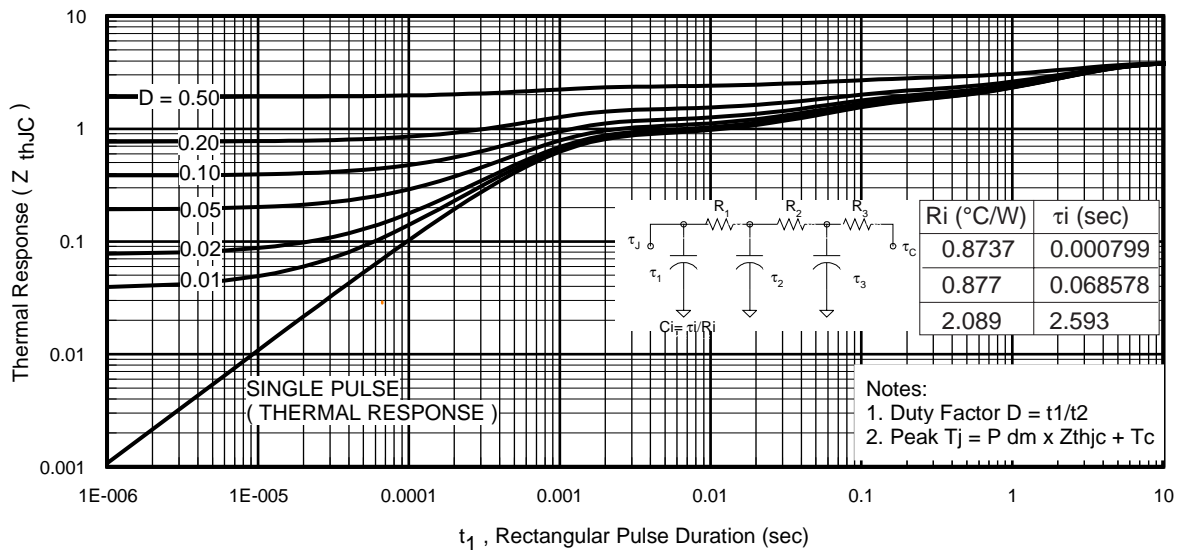

**Fig 11.** Maximum Effective Transient Thermal Impedance, Junction-to-Case

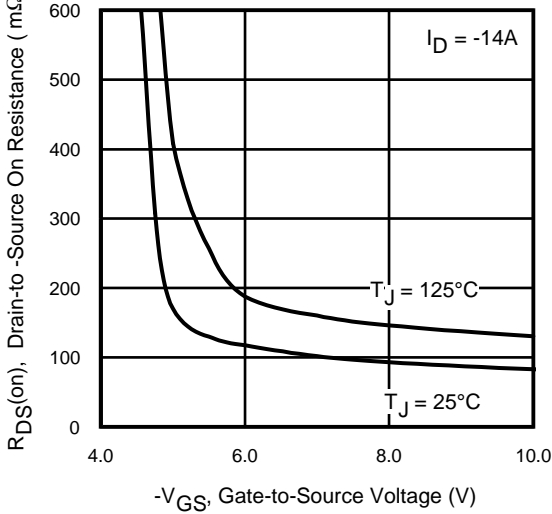

Fig 12. On-Resistance Vs. Gate Voltage

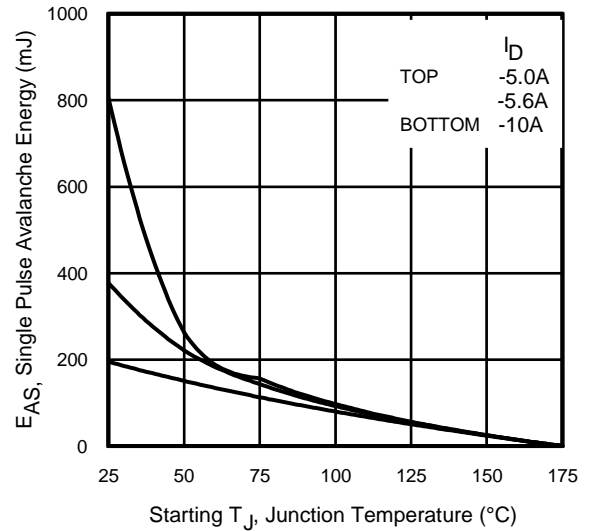

Fig 13. Maximum Avalanche Energy Vs. Drain Current

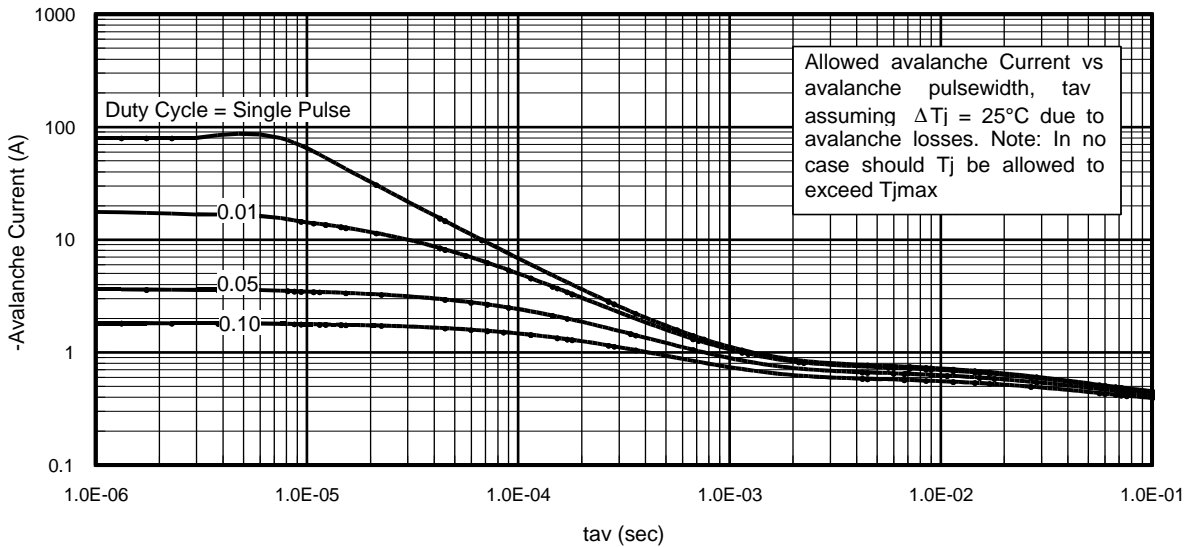

Fig 14. Typical Avalanche Current Vs. Pulsewidth

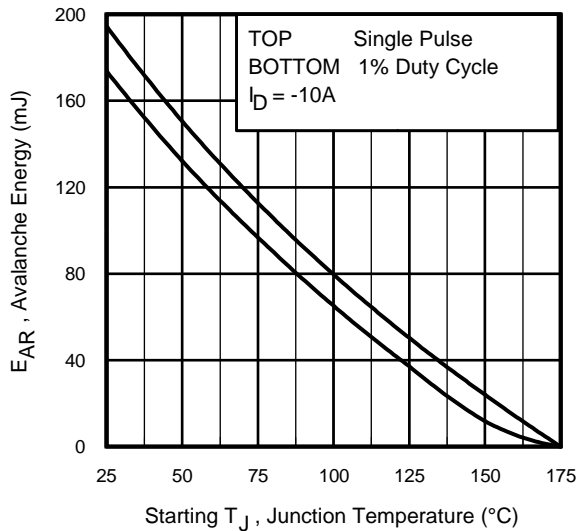

Fig 15. Maximum Avalanche Energy Vs. Temperature

**Notes on Repetitive Avalanche Curves , Figures 14, 15:**  
(For further info, see AN-1005 at [www.irf.com](http://www.irf.com))

1. Avalanche failures assumption:  
Purely a thermal phenomenon and failure occurs at a temperature far in excess of  $T_{jmax}$ . This is validated for every part type.
2. Safe operation in Avalanche is allowed as long as  $T_{jmax}$  is not exceeded.
3. Equation below based on circuit and waveforms shown in Figures 17a, 17b.
4.  $P_{D(ave)}$  = Average power dissipation per single avalanche pulse.
5. BV = Rated breakdown voltage (1.3 factor accounts for voltage increase during avalanche).
6.  $I_{av}$  = Allowable avalanche current.
7.  $\Delta T$  = Allowable rise in junction temperature, not to exceed  $T_{jmax}$  (assumed as 25°C in Figure 14, 15).  
 $t_{av}$  = Average time in avalanche.  
 $D$  = Duty cycle in avalanche =  $t_{av} \cdot f$   
 $Z_{thJC}(D, t_{av})$  = Transient thermal resistance, see figure 11)

$$P_{D(ave)} = 1/2 ( 1.3 \cdot BV \cdot I_{av} ) = \Delta T / Z_{thJC}$$

$$I_{av} = 2\Delta T / [1.3 \cdot BV \cdot Z_{thJC}]$$

$$E_{AS(AR)} = P_{D(ave)} \cdot t_{av}$$

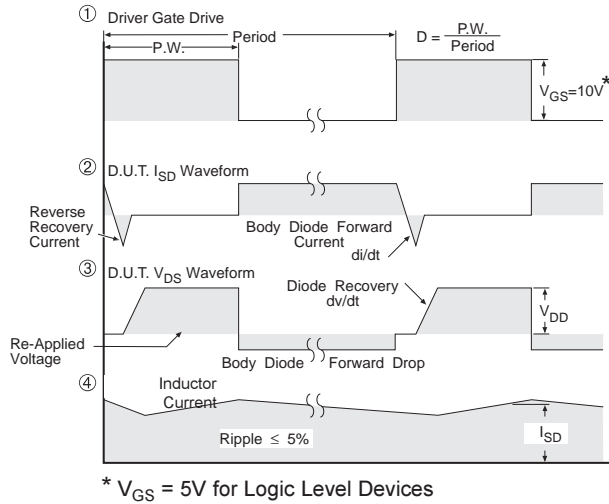
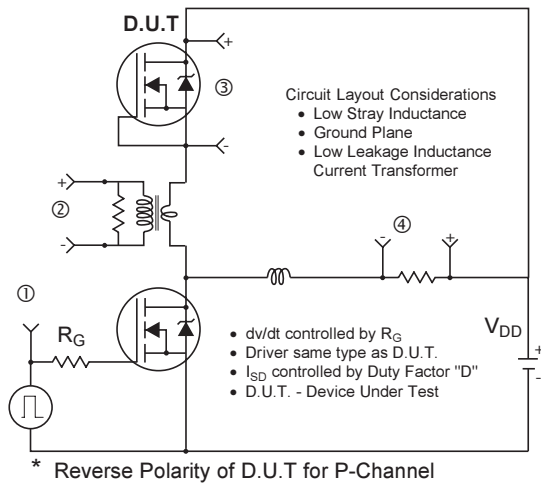

**Fig 16. Peak Diode Recovery  $dv/dt$  Test Circuit for P-Channel HEXFET® Power MOSFETs**

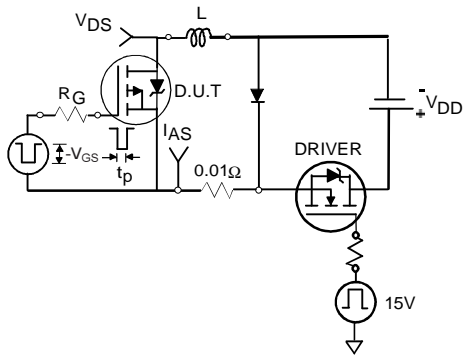

**Fig 17a. Unclamped Inductive Test Circuit**

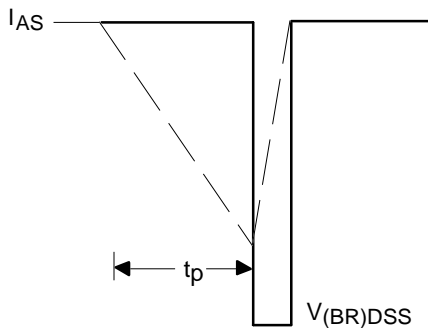

**Fig 17b. Unclamped Inductive Waveforms**

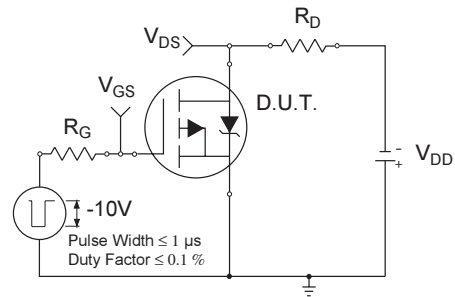

**Fig 18a. Switching Time Test Circuit**

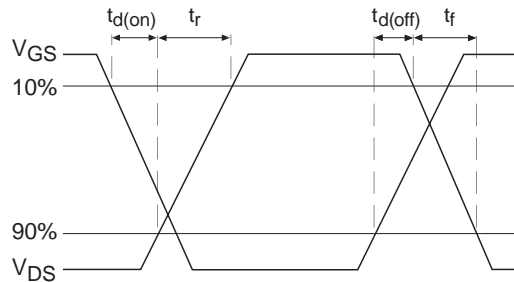

**Fig 18b. Switching Time Waveforms**

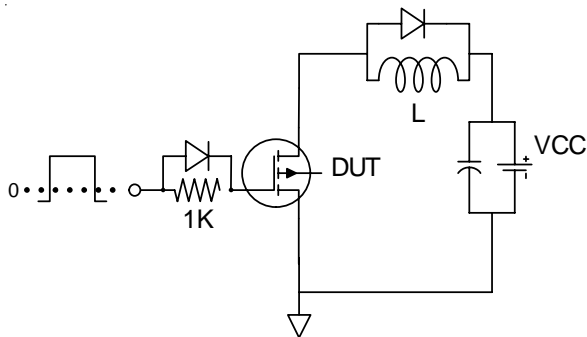

**Fig 19a. Gate Charge Test Circuit**

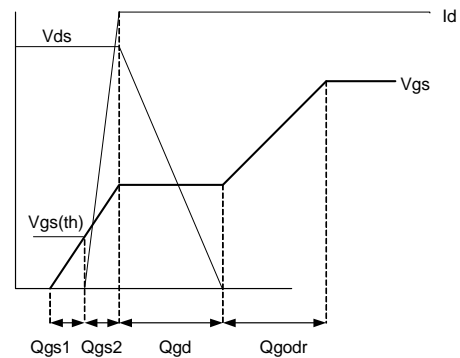

**Fig 19b Gate Charge Waveform**

## TO-220 Full-Pak Package Outline

Dimensions are shown in millimeters (inches)

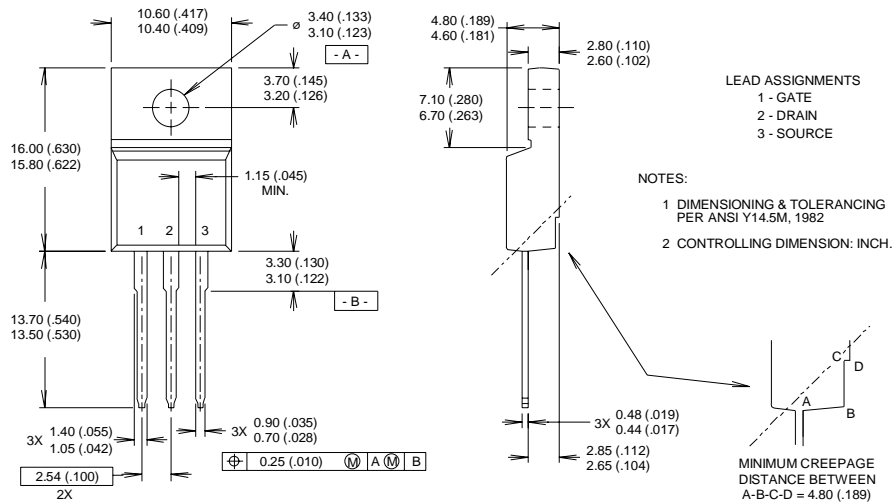

## TO-220 Full-Pak Part Marking Information

Notes: This part marking information applies to all devices produced before 02/26/2001 and currently for parts manufactured in GB.

EXAMPLE: THIS IS AN IRF840G WITH ASSEMBLY LOT CODE E401

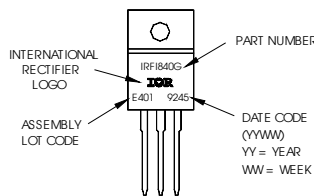

Notes: This part marking information applies to devices produced after 02/26/2001 in location other than GB.

EXAMPLE: THIS IS AN IRF840G WITH ASSEMBLY LOT CODE 3432 ASSEMBLED ON WW24 1999 IN THE ASSEMBLY LINE "K"

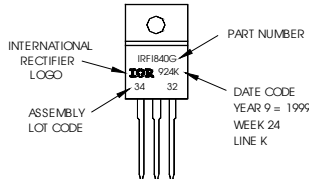

**TO-220 FullPak packages are not recommended for Surface Mount Application.**

### Notes:

- ① Repetitive rating; pulse width limited by max. junction temperature.
- ② Starting  $T_J = 25^\circ\text{C}$ ,  $L = 3.89\text{mH}$ ,  $R_G = 25\Omega$ ,  $I_{AS} = -10\text{A}$ .
- ③ Pulse width  $\leq 400\mu\text{s}$ ; duty cycle  $\leq 2\%$ .
- ④  $R_{\theta}$  is measured at  $T_J$  of approximately  $90^\circ\text{C}$ .
- ⑤ Limited by  $T_{jmax}$ . See Figs. 14, 15, 17a, 17b for repetitive avalanche information

Data and specifications subject to change without notice. This product has been designed for the Industrial market. Qualification Standards can be found on IR's Web site.