

# FRD Type : KCF16A40

## OUTLINE DRAWING

### FEATURES

- \* Similar to TO-247AC (TO-3P) Case
- \* Dual Diodes – Cathode Common
- \* Ultra – Fast Recovery
- \* Low Forward Voltage Drop
- \* High Surge Capability
- \* 200 Volts thru 600 Volts Types Available

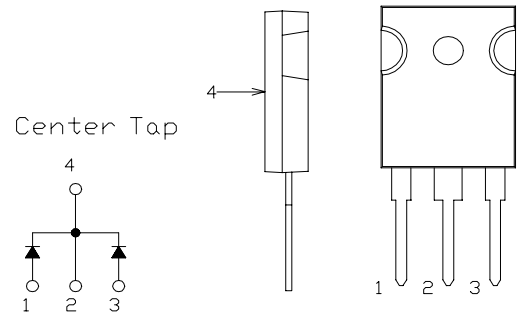

### Maximum Ratings

Approx Net Weight:5.55g

Rating	Symbol	KCF16A40		Unit
Repetitive Peak Reverse Voltage	$V_{RRM}$	400		V
Non-repetitive Peak Reverse Voltage	$V_{RSM}$	440		V
Average Rectified Output Current	$I_O$	16	$T_c=109^\circ\text{C}$ 50 Hz, Full Sine Wave Resistive Load	A
RMS Forward Current	$I_{F(RMS)}$	18		A
Surge Forward Current	$I_{FSM}$	120	50 Hz Full Sine Wave, 1 cycle Non-repetitive	A
Operating Junction Temperature Range	$T_{jw}$	- 40 to + 150		$^\circ\text{C}$
Storage Temperature Range	$T_{stg}$	- 40 to + 150		$^\circ\text{C}$
Mounting torque		0.5	Recommended value	N·m

### Electrical • Thermal Characteristics

Characteristics	Symbol	Conditions	Min.	Typ.	Max.	Unit
Peak Reverse Current	$I_{RM}$	$T_j=25^\circ\text{C}$ , $V_{RM}=V_{RRM}$ per Arm	-	-	30	$\mu\text{A}$
Peak Forward Voltage	$V_{FM}$	$T_j=25^\circ\text{C}$ , $I_{FM}=8\text{A}$ per Arm	-	-	1.25	V
Reverse Recovery Time	$t_{rr}$	$I_{FM}=8\text{A}$ , $-di/dt=50\text{A}/\mu\text{s}$ , $T_a=25^\circ\text{C}$	-	-	45	ns
Thermal Resistance	$R_{th(j-c)}$	Junction to Case	-	-	2	$^\circ\text{C}/\text{W}$

KCF16A40 OUTLINE DRAWING (Dimensions in mm)

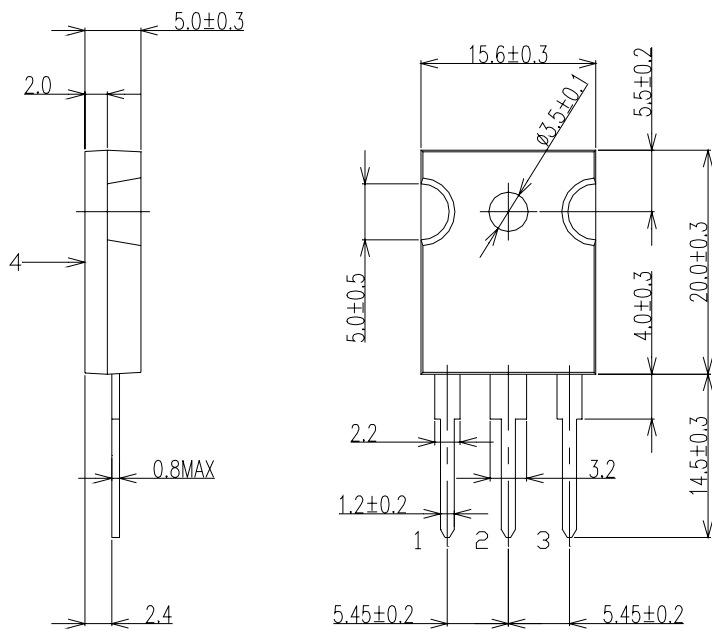

Center Tap

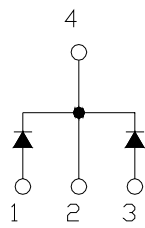

### FORWARD CURRENT VS. VOLTAGE

10ms Sine Wave Single Pulse

KCF16A40 (per Arm)

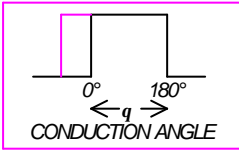
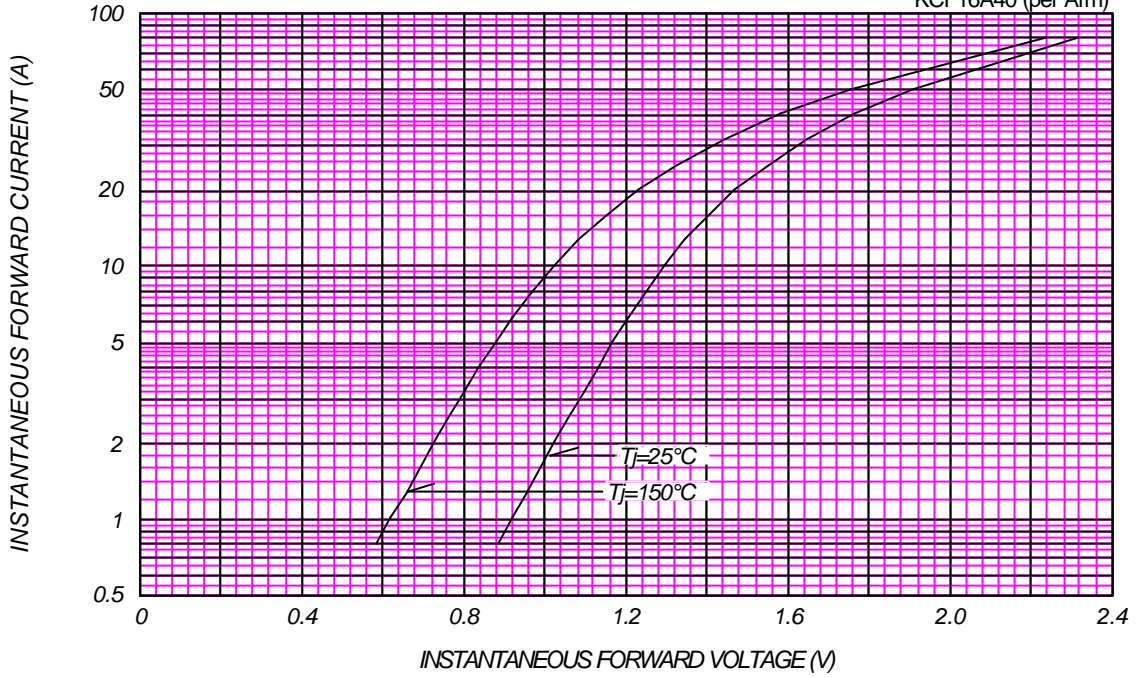

### AVERAGE FORWARD POWER DISSIPATION

KCF16A40 (Total)

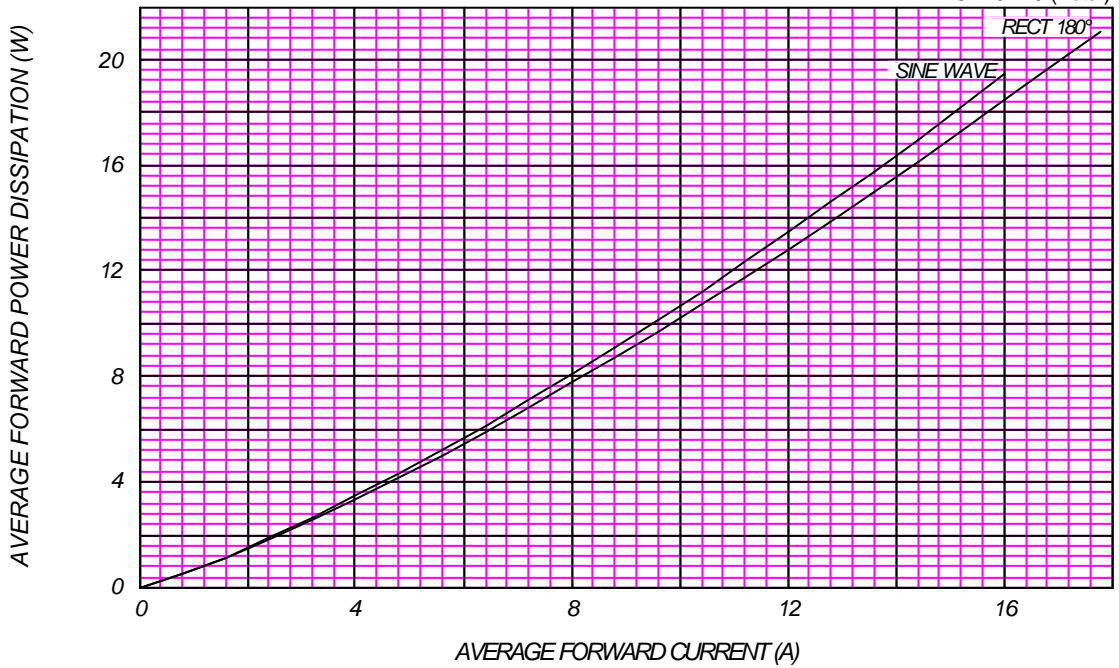



AVERAGE FORWARD CURRENT VS. CASE TEMPERATURE

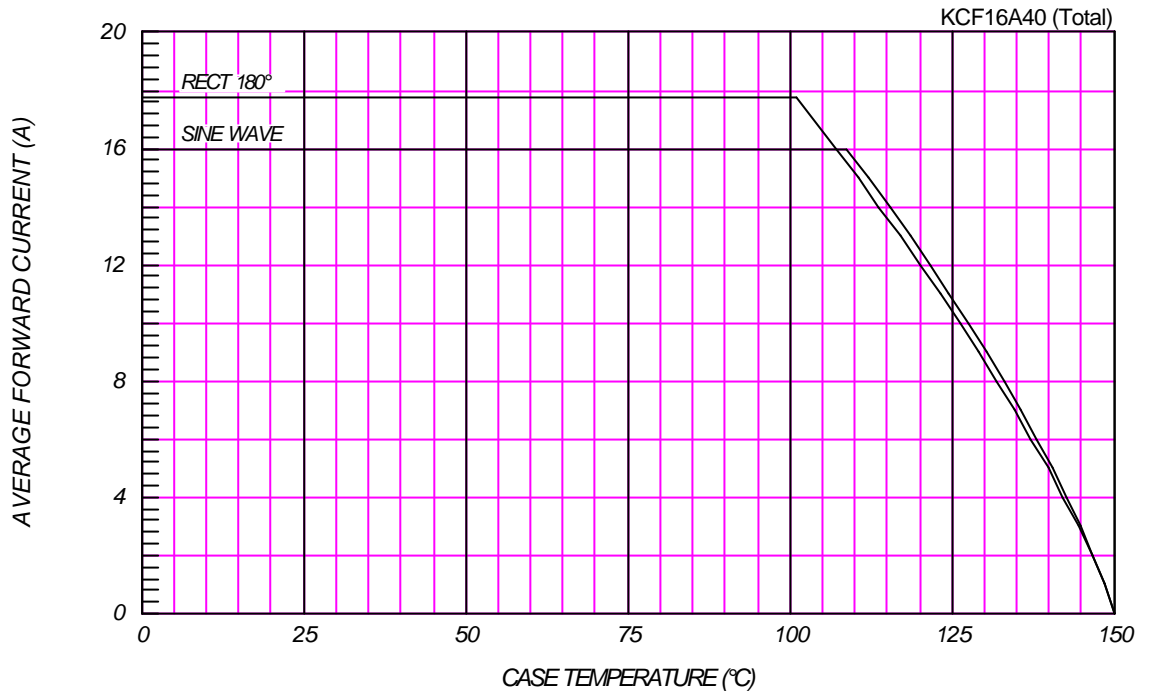

SURGE CURRENT RATINGS

f=50Hz, Sine Wave, Non-Repetitive, No Load

