

LC503TSB1-15H-A

Features

5mm Package
 High Luminous Intensity
 High Optical Power
 All Plastic Mold Type
 Water Clear Lens
 Lead Free

Applications

Decorative Lighting
 General Purpose Lighting
 Indoor Message Centers
 Instrumentation
 Medical Equipment

Maximum Ratings (Ta=25°C)

Characteristic	Symbol	Max.	Unit
Forward Current	I _F	25	mA
Reverse Voltage	V _R	5	V
Power Dissipation	P _D	100.00	mW
Operating Temperature	T _{opr}	-40 ~ +95	°C
Storage Temperature	T _{stg}	-40 ~ +100	°C
Soldering Temperature	T _{sol}	260	°C
Soldering Time	-	for 3 sec. max	-

Opto-Electrical Characteristics (Ta=25°C)

Characteristic	Symbol	Test Condition	Min	Typ	Max	Unit
Forward Voltage	V _F	I _F =20mA	-	3.40	4.00	V
Reverse Current	I _R	V _R =5V	-	-	100	μA
Luminous Intensity	I _v	I _F =20mA	3000.00	4500.00	-	mcd
Viewing Angle	2θ ^{1/2}	-	-	15°	-	deg.
Peak Wavelength	λ _p	I _F =20mA	-	458	-	nm
Dominant Wavelength	λ _d	I _F =20mA	-	460	-	nm
Spectral Line Half Width	Δλ	I _F =20mA	-	26	-	nm

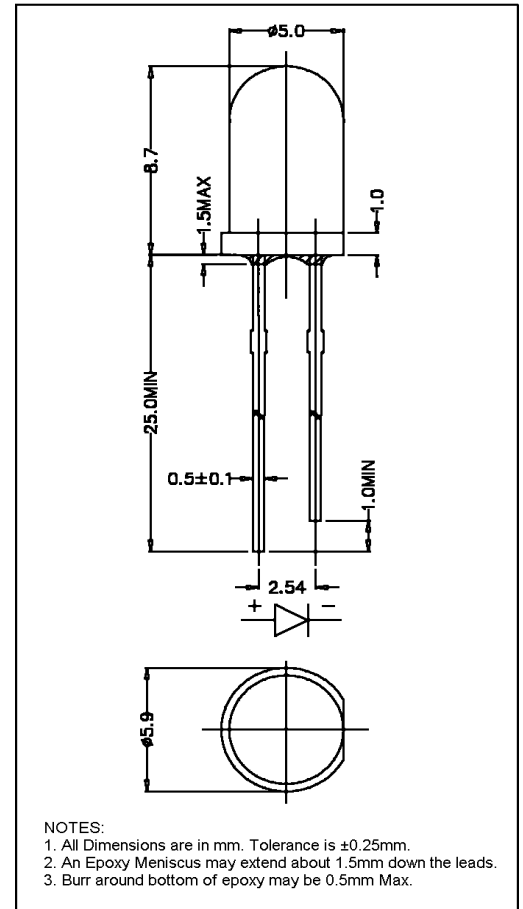

LC503TSB1-15H-A Graphs

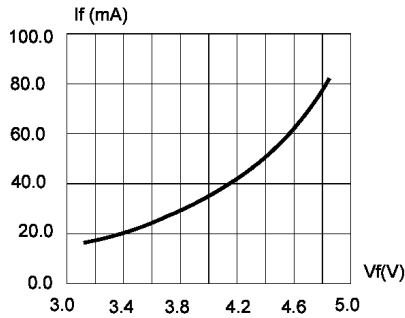

FIG.1 FORWARD CURRENT VS. FORWARD VOLTAGE.

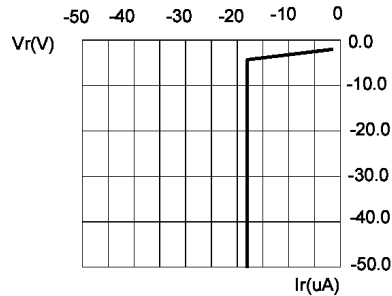

FIG.2 REVERSE CURRENT VS. REVERSE VOLTAGE.

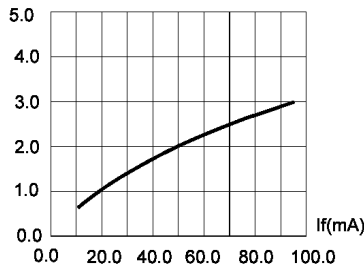

FIG.3 RELATIVE LUMINOUS INTENSITY VS. FORWARD CURRENT

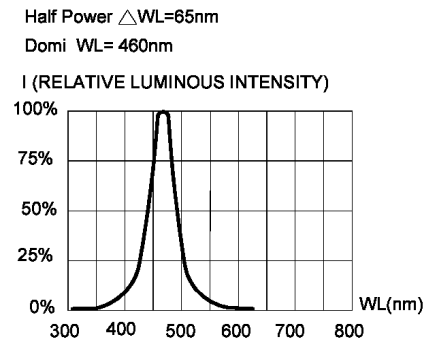

FIG.4 RELATIVE LUMINOUS INTENSITY VS. WAVELENGTH.

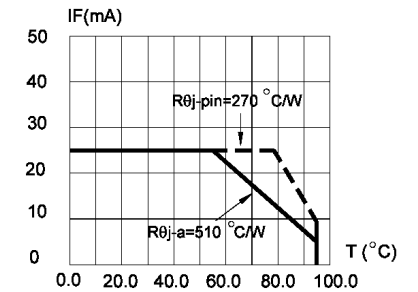

FIG.5 MAXIMUM FORWARD DC CURRENT VS. AMBIENT TEMPERATURE ($T_{jmax}=105^{\circ}$ C)

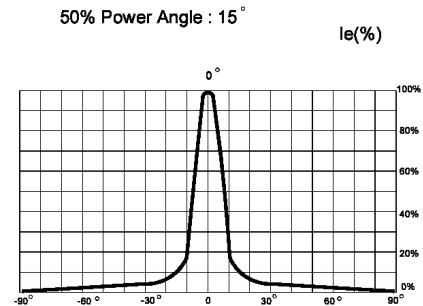

FIG.6 FAR FIELD PATTERN

1. Cathode PAD Area (0.18 X 0.18inch²)
2. Height above nominal seating plane in inches(0.3inch)