

Bias Resistor Transistors

NPN Silicon Surface Mount Transistors With Monolithic Bias Resistor Network

This new series of digital transistors is designed to replace a single device and its external resistor bias network. The BRT (Bias Resistor Transistor) contains a single transistor with a monolithic bias network consisting of two resistors; a series base resistor and a base-emitter resistor. The BRT eliminates these individual components by integrating them into a single device. The use of a BRT can reduce both system cost and board space. The device is housed in the SOT-723 package which is designed for low power surface mount applications.

- Simplifies Circuit Design
- Reduces Board Space
- Reduces Component Count
- The SOT-723 Package can be Soldered using Wave or Reflow.
- Available in 4 mm, 8000 Unit Tape & Reel
- These are Pb-Free Devices.

MAXIMUM RATINGS ($T_A = 25^\circ\text{C}$ unless otherwise noted)

Rating	Symbol	Value	Unit
Collector-Base Voltage	V_{CBO}	50	Vdc
Collector-Emitter Voltage	V_{CEO}	50	Vdc
Collector Current	I_C	100	mAdc

THERMAL CHARACTERISTICS

Characteristic	Symbol	Max	Unit
Total Device Dissipation $T_A = 25^\circ\text{C}$ Derate above 25°C	P_D	260 (Note 1) 600 (Note 2) 2.0 (Note 1) 4.8 (Note 2)	mW mW/ $^\circ\text{C}$
Thermal Resistance – Junction-to-Ambient	$R_{\theta JA}$	480 (Note 1) 205 (Note 2)	$^\circ\text{C/W}$
Junction Temperature	T_J	150	$^\circ\text{C}$
Storage Temperature Range	T_{stg}	-55 to +150	$^\circ\text{C}$

1. FR-4 @ Minimum Pad
2. FR-4 @ 1.0 x 1.0 inch Pad

LDTCT114EM3T5G Series

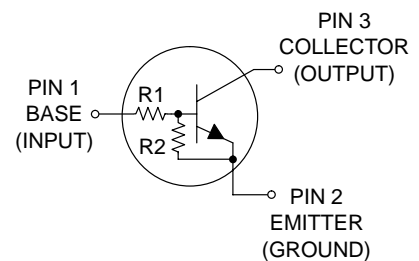
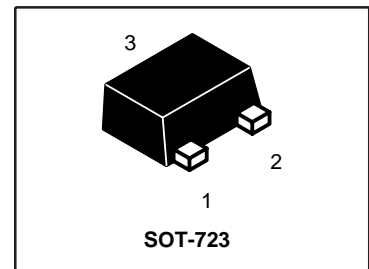

MARKING DIAGRAM



- xx = Specific Device Code
- M = Date Code

LDTTC114EM3T5G Series

DEVICE MARKING AND RESISTOR VALUES

Device	Marking	R1 (K)	R2 (K)	Package	Shipping
LDTTC114EM3T5G	8A	10	10	SOT-723 (Pb-Free)	8000/Tape & Reel
LDTTC124EM3T5G	8B	22	22		
LDTTC144EM3T5G	8C	47	47		
LDTTC114YM3T5G	8D	10	47		
LDTTC114TM3T5G	94	10	∞		
LDTTC143TM3T5G	8F	4.7	∞		
LDTTC123EM3T5G	8H	2.2	2.2		
LDTTC143EM3T5G	8J	4.7	4.7		
LDTTC143ZM3T5G	8K	4.7	47		
LDTTC124XM3T5G	8L	22	47		
LDTTC123JM3T5G	8M	2.2	47		
LDTTC115EM3T5G	8N	100	100		
LDTTC144WM3T5G	8P	47	22		
LDTTC144TM3T5G	8T	47	∞		

LDT C114EM3T5G Series

ELECTRICAL CHARACTERISTICS ($T_A = 25^\circ\text{C}$ unless otherwise noted)

Characteristic	Symbol	Min	Typ	Max	Unit
OFF CHARACTERISTICS					
Collector–Base Cutoff Current ($V_{CB} = 50\text{ V}, I_E = 0$)	I_{CBO}	–	–	100	nAdc
Collector–Emitter Cutoff Current ($V_{CE} = 50\text{ V}, I_B = 0$)	I_{CEO}	–	–	500	nAdc
Emitter–Base Cutoff Current ($V_{EB} = 6.0\text{ V}, I_C = 0$)	I_{EBO}	–	–	0.5	mAdc
LDT C114EM3T5G		–	–	0.2	
LDT C124EM3T5G		–	–	0.1	
LDT C144EM3T5G		–	–	0.2	
LDT C114YM3T5G		–	–	0.9	
LDT C114TM3T5G		–	–	1.9	
LDT C143TM3T5G		–	–	2.3	
LDT C123EM3T5G		–	–	1.5	
LDT C143EM3T5G		–	–	0.18	
LDT C143ZM3T5G		–	–	0.13	
LDT C124XM3T5G		–	–	0.2	
LDT C123JM3T5G		–	–	0.05	
LDT C115EM3T5G		–	–	0.13	
LDT C144WM3T5G		–	–	0.2	
LDT C144TM3T5G		–	–		
Collector–Base Breakdown Voltage ($I_C = 10\ \mu\text{A}, I_E = 0$)	$V_{(BR)CBO}$	50	–	–	Vdc
Collector–Emitter Breakdown Voltage (Note 3) ($I_C = 2.0\text{ mA}, I_B = 0$)	$V_{(BR)CEO}$	50	–	–	Vdc

ON CHARACTERISTICS (Note 3)

DC Current Gain ($V_{CE} = 10\text{ V}, I_C = 5.0\text{ mA}$)	LDT C114EM3T5G LDT C124EM3T5G LDT C144EM3T5G LDT C114YM3T5G LDT C114TM3T5G LDT C143TM3T5G LDT C123EM3T5G LDT C143EM3T5G LDT C143ZM3T5G LDT C124XM3T5G LDT C123JM3T5G LDT C115EM3T5G LDT C144WM3T5G LDT C144TM3T5G	h_{FE}	35 60 80 80 160 160 8.0 15 80 80 80 80 80 160	60 100 140 140 350 350 15 30 200 150 140 150 140 350	– – – – – – – – – – – – – –	
Collector–Emitter Saturation Voltage ($I_C = 10\text{ mA}, I_B = 0.3\text{ mA}$) ($I_C = 10\text{ mA}, I_B = 5\text{ mA}$) ($I_C = 10\text{ mA}, I_B = 1\text{ mA}$)	LDT C123EM3T5G LDT C143TM3T5G/LDT C114TM3T5G/ LDT C143EM3T5G/LDT C143ZM3T5G/ LDT C124XM3T5G/LDT C144TM3T5G	$V_{CE(sat)}$	–	–	0.25	Vdc
Output Voltage (on) ($V_{CC} = 5.0\text{ V}, V_B = 2.5\text{ V}, R_L = 1.0\text{ k}\Omega$)	LDT C114EM3T5G LDT C124EM3T5G LDT C114YM3T5G LDT C114TM3T5G LDT C143TM3T5G LDT C123EM3T5G LDT C143EM3T5G LDT C143ZM3T5G LDT C124XM3T5G LDT C123JM3T5G	V_{OL}	– – – – – – – – – –	– – – – – – – – – –	0.2 0.2 0.2 0.2 0.2 0.2 0.2 0.2 0.2 0.2	Vdc
($V_{CC} = 5.0\text{ V}, V_B = 3.5\text{ V}, R_L = 1.0\text{ k}\Omega$)	LDT C144EM3T5G		–	–	0.2	
($V_{CC} = 5.0\text{ V}, V_B = 5.5\text{ V}, R_L = 1.0\text{ k}\Omega$)	LDT C144TM3T5G		–	–	0.2	
($V_{CC} = 5.0\text{ V}, V_B = 4.0\text{ V}, R_L = 1.0\text{ k}\Omega$)	LDT C115EM3T5G LDT C144WM3T5G		– –	– –	0.2 0.2	

3. Pulse Test: Pulse Width < 300 μs , Duty Cycle < 2.0%.

LDTC114EM3T5G Series

ELECTRICAL CHARACTERISTICS ($T_A = 25^\circ\text{C}$ unless otherwise noted)

Characteristic	Symbol	Min	Typ	Max	Unit
----------------	--------	-----	-----	-----	------

ON CHARACTERISTICS (Note 4)

Characteristic	Symbol	Min	Typ	Max	Unit
Output Voltage (off) ($V_{CC} = 5.0\text{ V}$, $V_B = 0.5\text{ V}$, $R_L = 1.0\text{ k}\Omega$) ($V_{CC} = 5.0\text{ V}$, $V_B = 0.25\text{ V}$, $R_L = 1.0\text{ k}\Omega$) LDTC143TM3T5G LDTC143ZM3T5G LDTC114TM3T5G LDTC144TM3T5G	V_{OH}	4.9	–	–	Vdc
Input Resistor LDTC114EM3T5G LDTC124EM3T5G LDTC144EM3T5G LDTC114YM3T5G LDTC114TM3T5G LDTC143TM3T5G LDTC123EM3T5G LDTC143EM3T5G LDTC143ZM3T5G LDTC124XM3T5G LDTC123JM3T5G LDTC115EM3T5G LDTC144WM3T5G LDTC144TM3T5G	R1	7.0 15.4 32.9 7.0 7.0 3.3 1.5 3.3 3.3 15.4 1.54 70 32.9 32.9	10 22 47 10 10 4.7 2.2 4.7 4.7 22 2.2 100 47 47	13 28.6 61.1 13 13 6.1 2.9 6.1 6.1 28.6 2.86 130 61.1 61.1	k Ω
Resistor Ratio LDTC114EM3T5G/LDTC124EM3T5G/ LDTC144EM3T5G/LDTC115EM3T5G LDTC114YM3T5G LDTC143TM3T5G/LDTC114TM3T5G/LDTC144TM3T5G LDTC123EM3T5G/LDTC143EM3T5G LDTC143ZM3T5G LDTC124XM3T5G LDTC123JM3T5G LDTC144WM3T5G	R_1/R_2	0.8 0.17 – 0.8 0.055 0.38 0.038 1.7	1.0 0.21 – 1.0 0.1 0.47 0.047 2.1	1.2 0.25 – 1.2 0.185 0.56 0.056 2.6	

4. Pulse Test: Pulse Width < 300 μs , Duty Cycle < 2.0%.

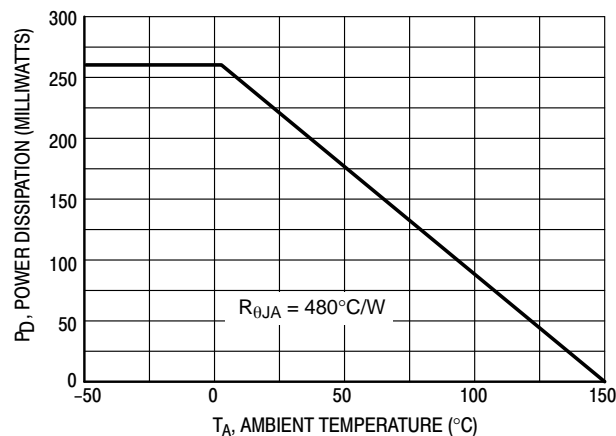

Figure 1. Derating Curve

LDT C114EM3T5G Series

TYPICAL ELECTRICAL CHARACTERISTICS – LDT C114EM3T5G

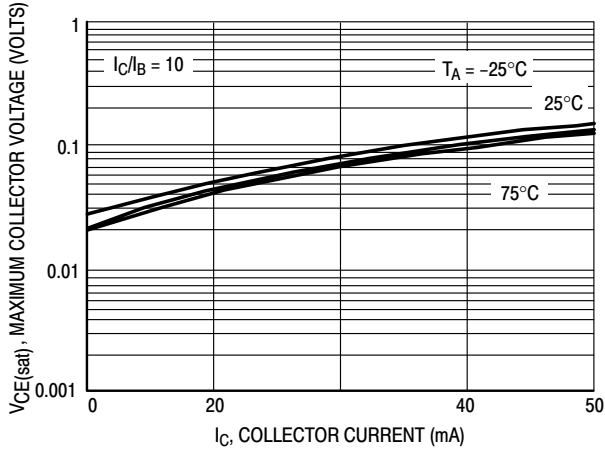

Figure 2. $V_{CE(sat)}$ versus I_C

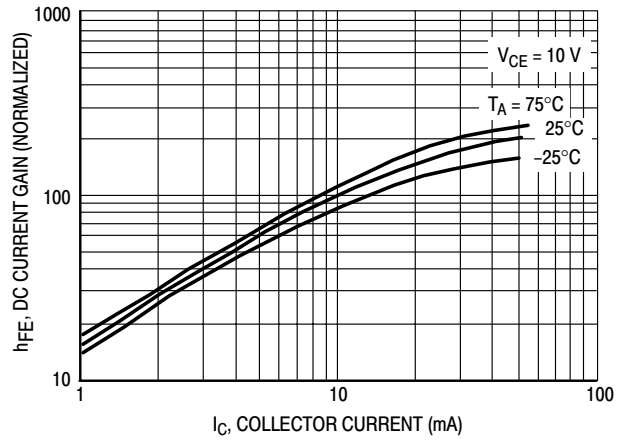

Figure 3. DC Current Gain

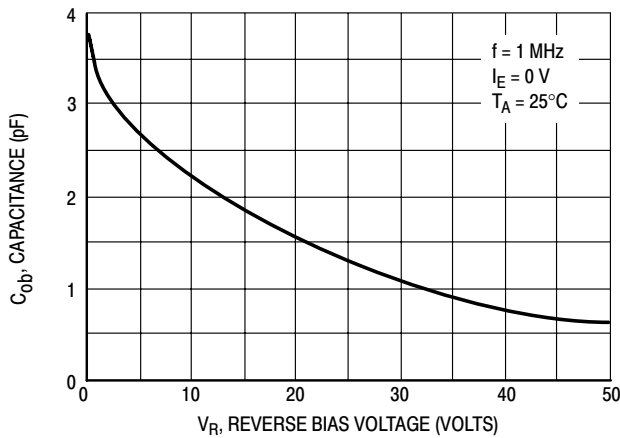

Figure 4. Output Capacitance

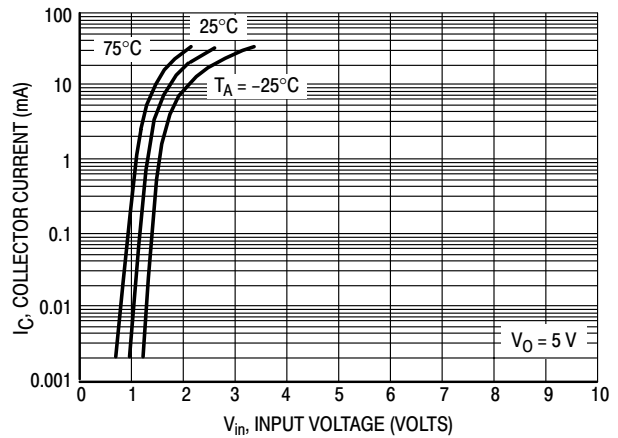

Figure 5. Output Current versus Input Voltage

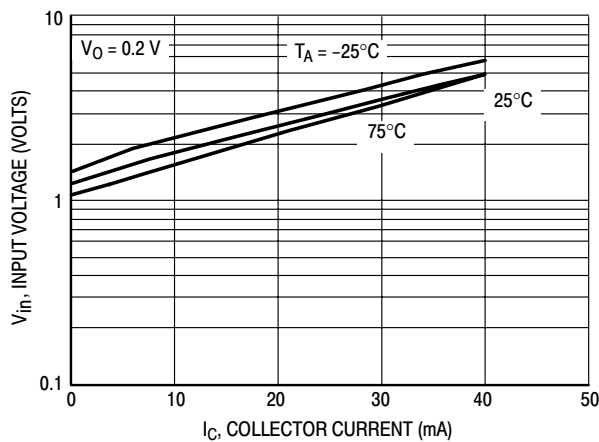

Figure 6. Input Voltage versus Output Current

LDT C114EM3T5G Series

TYPICAL ELECTRICAL CHARACTERISTICS – LDT C124EM3T5G

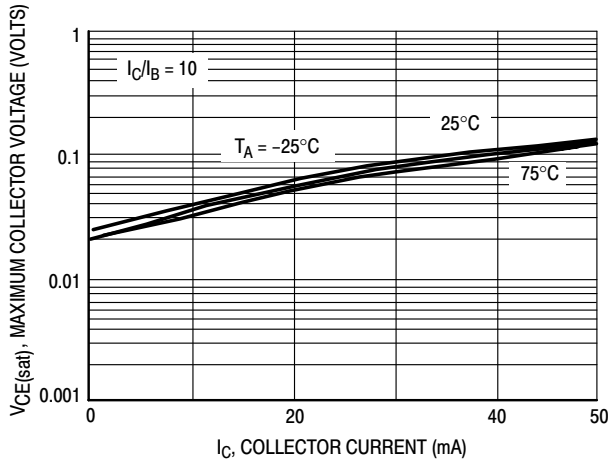

Figure 7. $V_{CE(sat)}$ versus I_C

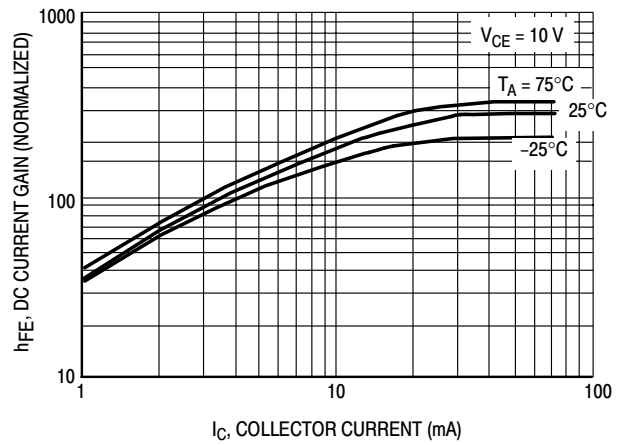

Figure 8. DC Current Gain

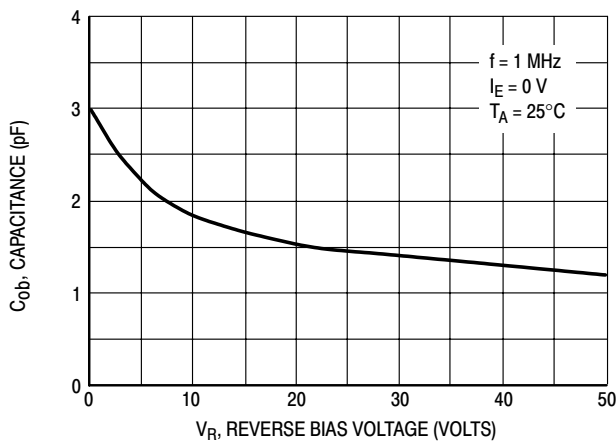

Figure 9. Output Capacitance

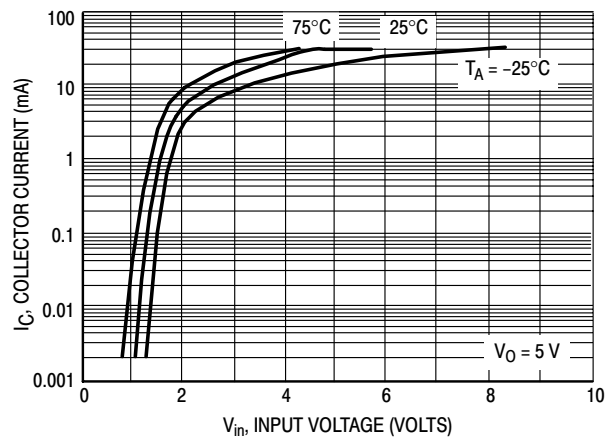

Figure 10. Output Current versus Input Voltage

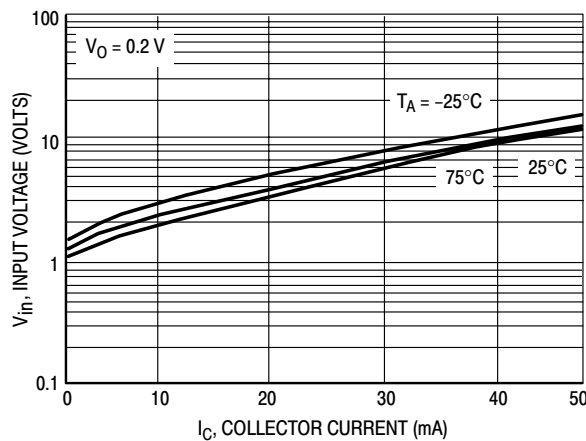

Figure 11. Input Voltage versus Output Current

LDT C114EM3T5G Series

TYPICAL ELECTRICAL CHARACTERISTICS – LDT C144EM3T5G

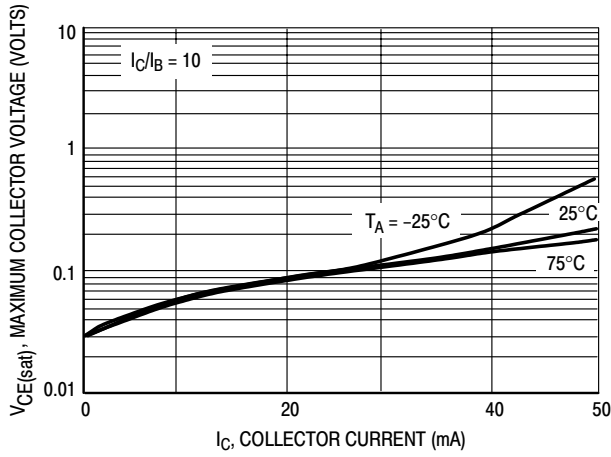

Figure 12. $V_{CE(sat)}$ versus I_C

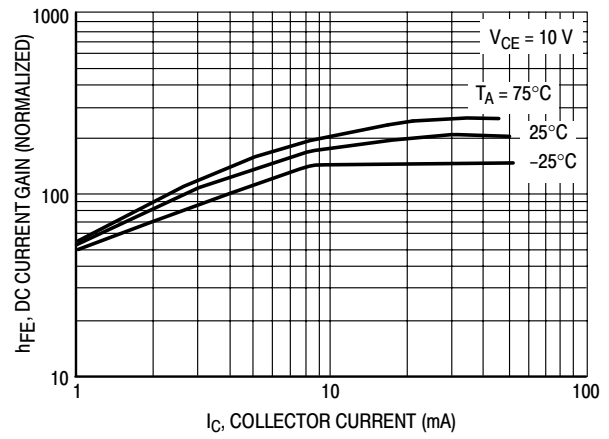

Figure 13. DC Current Gain

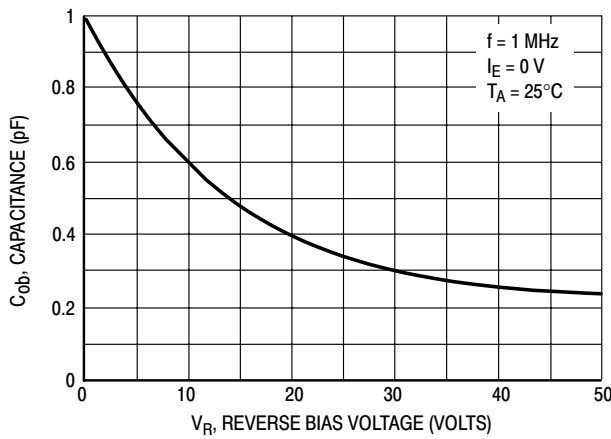

Figure 14. Output Capacitance

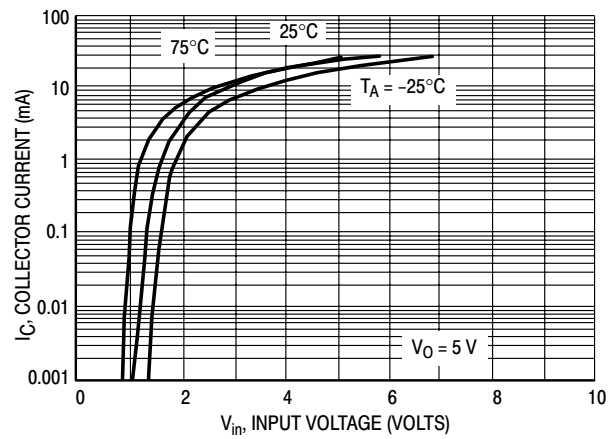

Figure 15. Output Current versus Input Voltage

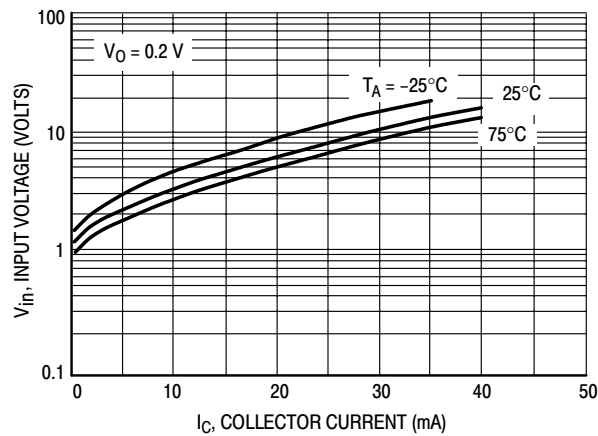

Figure 16. Input Voltage versus Output Current

LDTCT114EM3T5G Series

TYPICAL ELECTRICAL CHARACTERISTICS – LDTCT114YM3T5G

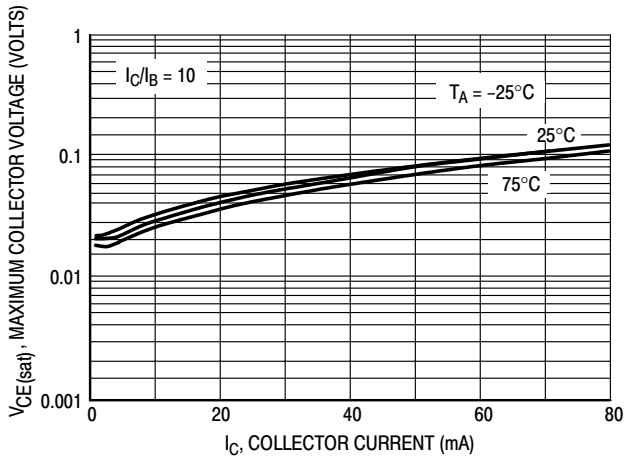

Figure 17. $V_{CE(sat)}$ versus I_C

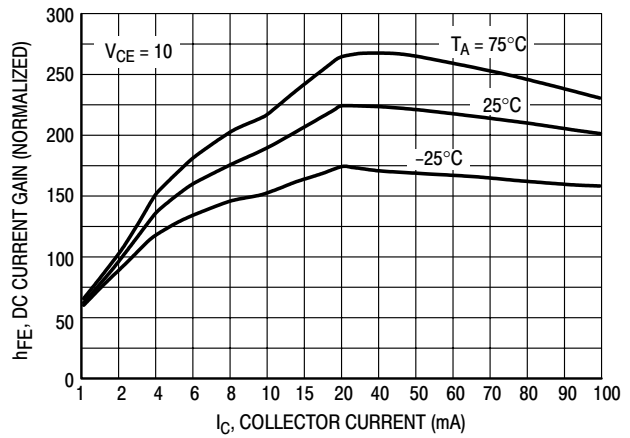

Figure 18. DC Current Gain

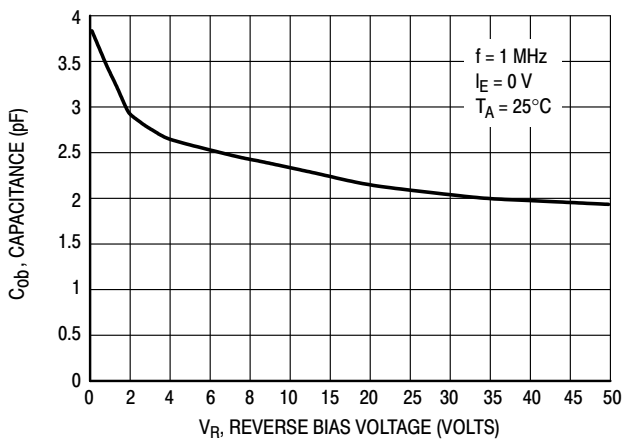

Figure 19. Output Capacitance

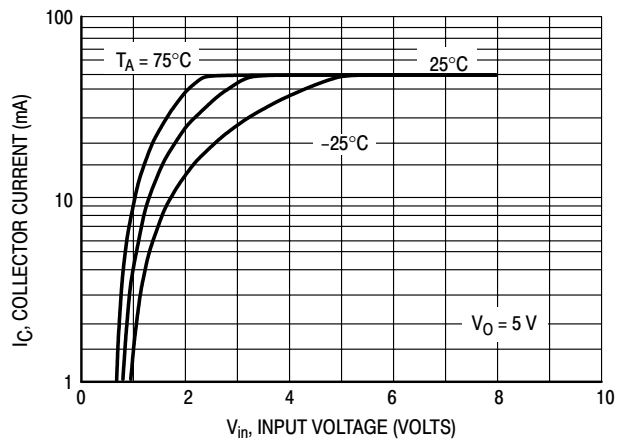

Figure 20. Output Current versus Input Voltage

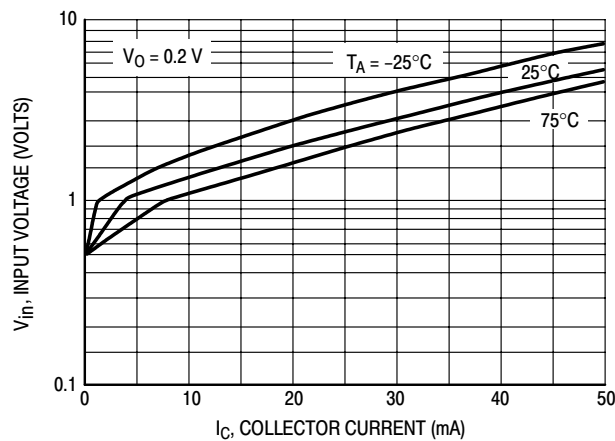

Figure 21. Input Voltage versus Output Current

LDTCT114EM3T5G Series

TYPICAL APPLICATIONS FOR NPN BRTs

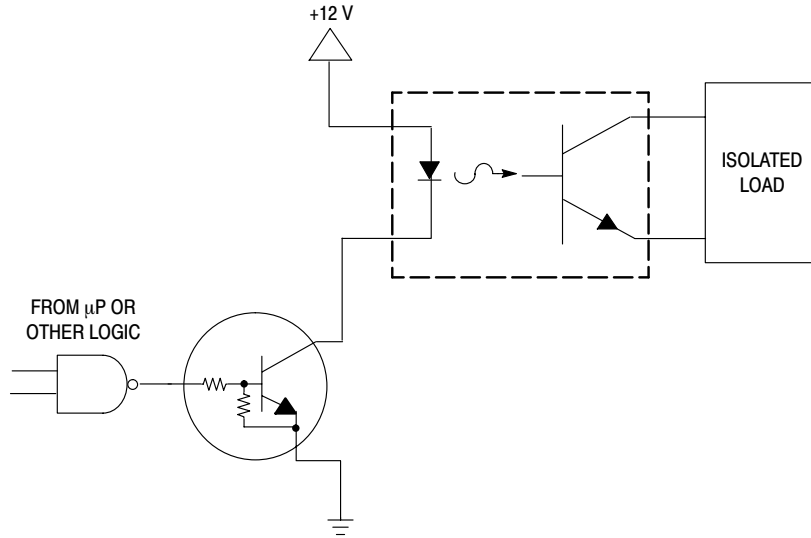

Figure 22. Level Shifter: Connects 12 or 24 Volt Circuits to Logic

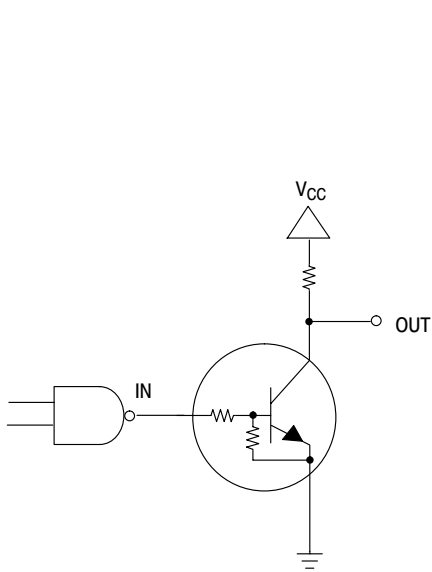

Figure 23. Open Collector Inverter: Inverts the Input Signal

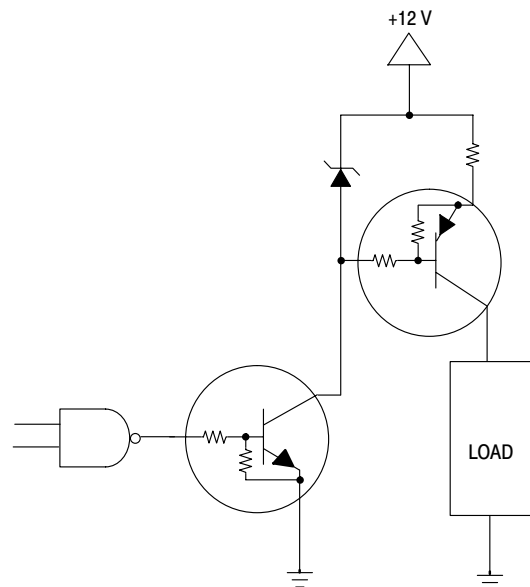
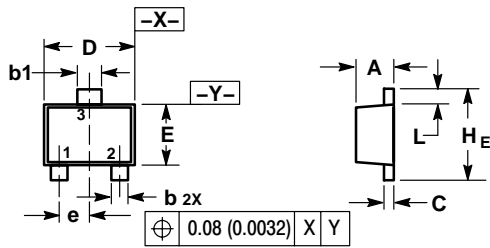

Figure 24. Inexpensive, Unregulated Current Source

LDT C114EM3T5G Series

PACKAGE DIMENSIONS

SOT-723



NOTES:

1. DIMENSIONING AND TOLERANCING PER ANSI Y14.5M, 1982.
2. CONTROLLING DIMENSION: MILLIMETERS.
3. MAXIMUM LEAD THICKNESS INCLUDES LEAD FINISH. MINIMUM LEAD THICKNESS IS THE MINIMUM THICKNESS OF BASE MATERIAL.
4. DIMENSIONS D AND E DO NOT INCLUDE MOLD FLASH, PROTRUSIONS OR GATE BURRS.

DIM	MILLIMETERS			INCHES		
	MIN	NOM	MAX	MIN	NOM	MAX
A	0.45	0.50	0.55	0.018	0.020	0.022
b	0.15	0.20	0.27	0.0059	0.0079	0.0106
b1	0.25	0.3	0.35	0.010	0.012	0.014
C	0.07	0.12	0.17	0.0028	0.0047	0.0067
D	1.15	1.20	1.25	0.045	0.047	0.049
E	0.75	0.80	0.85	0.03	0.032	0.034
e	0.40 BSC			0.016 BSC		
H E	1.15	1.20	1.25	0.045	0.047	0.049
L	0.15	0.20	0.25	0.0059	0.0079	0.0098

- PIN 1. BASE
2. EMITTER
3. COLLECTOR

SOLDERING FOOTPRINT

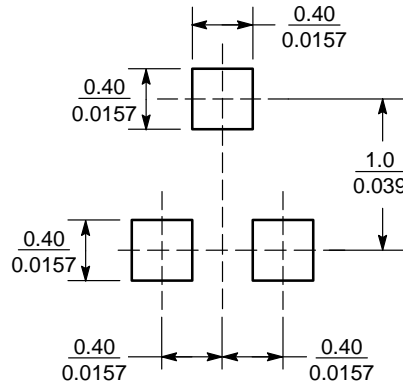

(mm / inches)