

LM1-AHR1-01-N1

Features

Industry Standard 1210 PLCC Package (3.2 x 2.8mm)
 High Operating Temperature Range: $-40^{\circ} \sim +100^{\circ} \text{C}$
 High luminosity with low power consumption
 120° Viewing Angle
 Wave and Re-flow Solderable

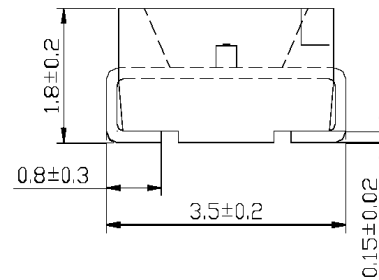

Applications

Indicators
 Illuminators
 LCD Backlights
 Automobile Applications

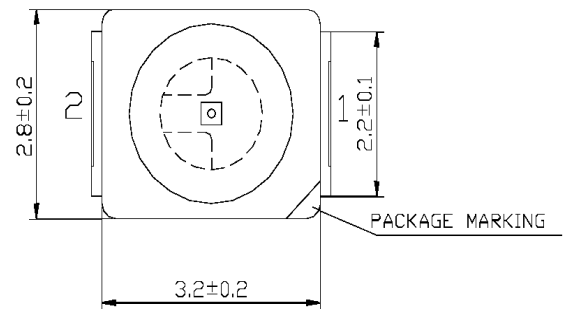

Maximum Ratings (Ta=25°C)

Characteristic	Symbol	Max.	Unit
Forward Current	I _F	50	mA
Reverse Voltage	V _R	5	V
Power Dissipation	P _D	130.00	mW
Operating Temperature	T _{opr}	-40 ~ +100	°C
Storage Temperature	T _{stg}	-40 ~ +100	°C
Soldering Temperature	T _{sol}	260	°C
Soldering Time	-	for 3 sec. max	-

Opto-Electrical Characteristics (Ta=25°C)

Characteristic	Symbol	Test Condition	Min	Typ	Max	Unit
Forward Voltage	V _F	I _F =20mA	-	2.10	2.60	V
Reverse Current	I _R	V _R =5V	-	-	10	μA
Luminous Intensity	I _v	I _F =20mA	280.00	500.00	-	mcd
Viewing Angle	2θ ^{1/2}	-	-	120°	-	deg.
Peak Wavelength	λ _p	I _F =20mA	-	632	-	nm
Dominant Wavelength	λ _d	I _F =20mA	-	624	-	nm
Spectral Line Half Width	Δλ	I _F =20mA	-	20	-	nm

LM1-AHR1-01-N1 Graphs

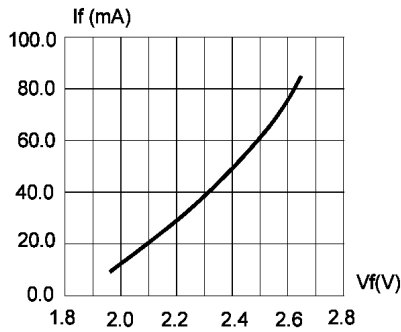

FIG.1 FORWARD CURRENT VS. FORWARD VOLTAGE.

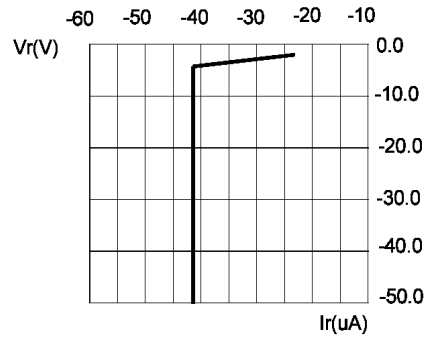

FIG.2 REVERSE CURRENT VS. REVERSE VOLTAGE.

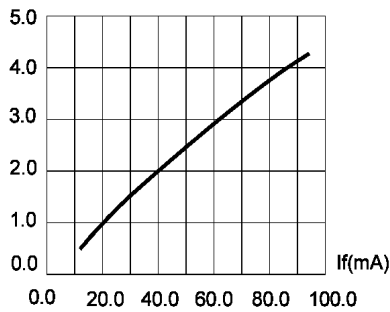

FIG.3 RELATIVE LUMINOUS INTENSITY VS. FORWARD CURRENT.

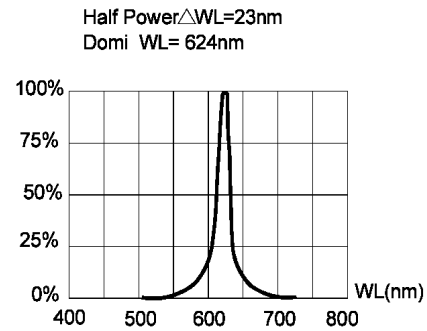

FIG.4 RELATIVE LUMINOUS INTENSITY VS. WAVELENGTH.

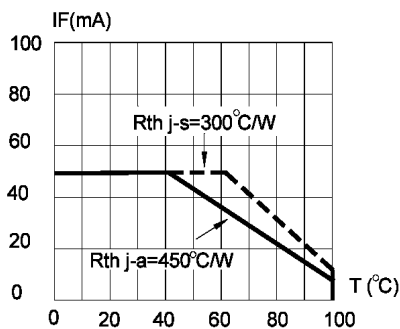

FIG.5 MAXIMUM FORWARD DC CURRENT VS TEMPERATURE. DERATING BASED ON Tjmax=110°C

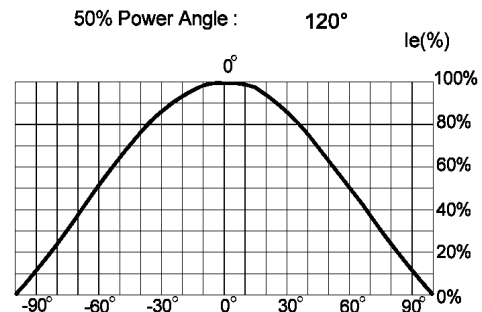

FIG.6 FAR FIELD PATTERN.