

# Non Magnetic SMQ HIPAX PIN Diode

MA4P7470F-1072T

## Features

- Non-Magnetic Package Suitable for MRI Applications
- Rectangular MELF SMQ Ceramic Package
- Hermetically Sealed
- Lower  $R_s$  for Lower Series Loss
- Longer  $\tau_L$  for Lower Intermodulation Distortion
- Lower  $C_j$  for Higher Series Isolation
- Higher Average Incident Power Handling Capability

## Description

The MA4P7470F-1072T is a surface mountable PIN diode in a Non-Magnetic ( patent pending ) Metal Electrode Leadless Faced (MELF) package. The device incorporates M/A-COM's proven HIPAX technology to produce a low inductance ceramic package with no ribbons or whisker wires. The package utilizes M/A-COM's new non-magnetic plating process to provide an extremely low permeability, hermetically sealed package. Incorporated in the package is a passivated PIN diode that is full face bonded to both the cathode and anode of the chip to maximize surface area for lower electrical and thermal resistance. The MA4P7470F-1072T has been comprehensively characterized both electrically and mechanically to ensure repeatable and predictable performance.

## Applications

The diodes are well suited for use in low loss, low distortion, and high power switching circuits applicable for high magnetic field environments from HF through UHF frequencies. The lower thermal resistance of this device provides excellent higher average performance at RF power incident levels up to 200 watts CW. This device is designed to meet the most rigorous electrical and mechanical requirements of MRI testing environments.

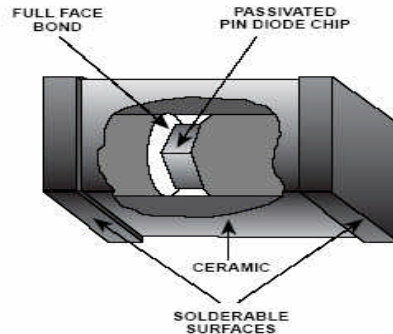

## Designed for Automated Assembly

These SMQ PIN diodes are designed for high volume tape and reel assembly. The rectangular package design provides for highly efficient automatic pick and place assembly techniques. The parallel flat surfaces are suitable for key jaw or vacuum pickup techniques. All solder able surfaces are tin plated and compatible with reflow and vapor phase soldering methods.

## Environmental Capability

HIPAX devices are applicable for use in industrial and military applications and can be screened to meet the environmental requirements of MIL-STD-750, MIL-STD-202 as well as other military standards. The table below lists some of the MIL-STD 750 tests the device is designed to meet.

MIL-STD-750		
Test	Method	Description
High Temperature Storage	1031	+150 °C, for 340 Hours
Temperature Shock	1051	-65 °C to +125 °C, 20 Cycles
HTRB	1038	80% of rated $V_B$ , +150 °C, for 96 Hours
Moisture Resistance	1021	No Initial Conditioning, 85 % RH, +85° C
Gross Leak	1071 Cond. E	Dye Penetrant Visual
Vibration Fatigue	2046	20,000 G's, 60 Hz, x, y, z axis
Solderability	2026	Test Temperature = +245 °C

## Electrical Specifications @ +25 °C

Parameter	Symbol	Condition	Unit Value
Forward Voltage (Maximum)	$V_F$	$I_F = +100 \text{ mA}$	$1.0 V_{DC}$
Voltage Rating (Minimum)	$V_R$	$I_r = -10 \text{ uA}$	$I - 800 I V_{DC}$
Total Capacitance (Maximum)	$C_T$	$-100 \text{ V @ } 100 \text{ MHz}$	$0.7 \text{ pF}$
Series Resistance (Maximum)	$R_S$	$+100 \text{ mA @ } 100 \text{ MHz}$	$0.8 \text{ Ohms}$
Parallel Resistance (Minimum)	$R_P$	$-10 \text{ V @ } 100 \text{ MHz}$	$50 \text{ K } \Omega$
Carrier Lifetime (Nominal)	$\tau_L$	$+6 \text{ mA} / -10 \text{ mA @}$ $(50\% - 90\% \text{ Voltage})$	$6.5 \text{ } \mu\text{s}$
I-Region Length (Nominal)	$\mu\text{m}$	-	$140 \text{ } \mu\text{m}$
C.W. Thermal Resistance (Maximum)	$\theta$	$I_H = 1\text{A}, I_L = 10 \text{ mA},$ $T = 1 \text{ mS}$	$13 \text{ } ^\circ\text{C/W}$
Power Dissipation in Free Air (Maximum)	$W$	$I_F = +100 \text{ mA}$	$4 \text{ W}$
Power Dissipation with Diode Case at Tambient (Maximum)	$P_D$	$I_F = +100 \text{ mA}$	$12 \text{ W}$

Absolute Maximum Ratings<sup>1</sup> @ 25°C

Parameter	Absolute Maximum
Operating Temperature	$-65 \text{ } ^\circ\text{C}$ to $+125 \text{ } ^\circ\text{C}$
Storage Temperature	$-65 \text{ } ^\circ\text{C}$ to $+150 \text{ } ^\circ\text{C}$
Diode Junction Temperature	$+175 \text{ } ^\circ\text{C}$ Continuous
Diode Mounting Temperature	$+235 \text{ } ^\circ\text{C}$ for 10 seconds
RF C.W. Incident Power	$+ 53 \text{ dBm C.W.}$
Forward D.C. Current	$+ 150 \text{ mA}$
Reverse Voltage @ $-10 \text{ uA}$	$I - 900 \text{ V I}$

1. Exceeding these limits may cause permanent damage.

Mechanical Outline

Case Style	Dimensions in Inches (mm)		
	A Square Min / Max	B Min / Max	C Min / Max
1072	0.080 / 0.095 (2.03 / 2.41)	0.115 / 0.135 (2.92 / 3.43)	0.008 / 0.030 (.203 / .762)

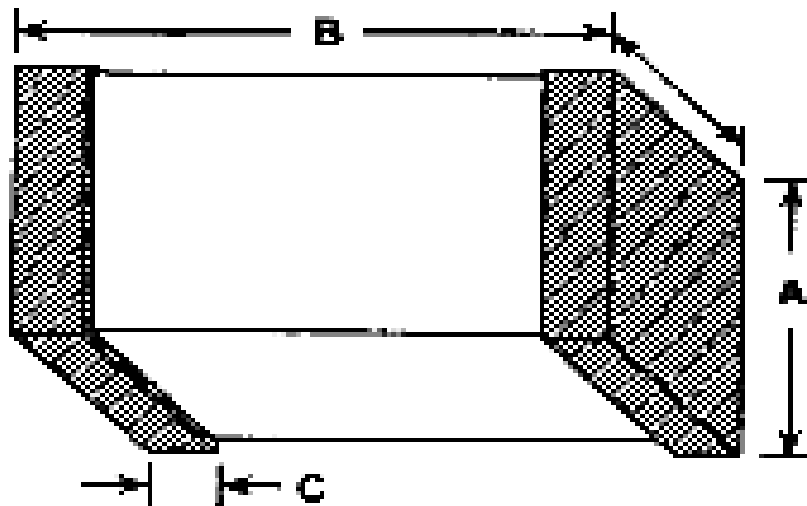

Typical Electrical Performance

MA4P7470F-1072T Rs vs I

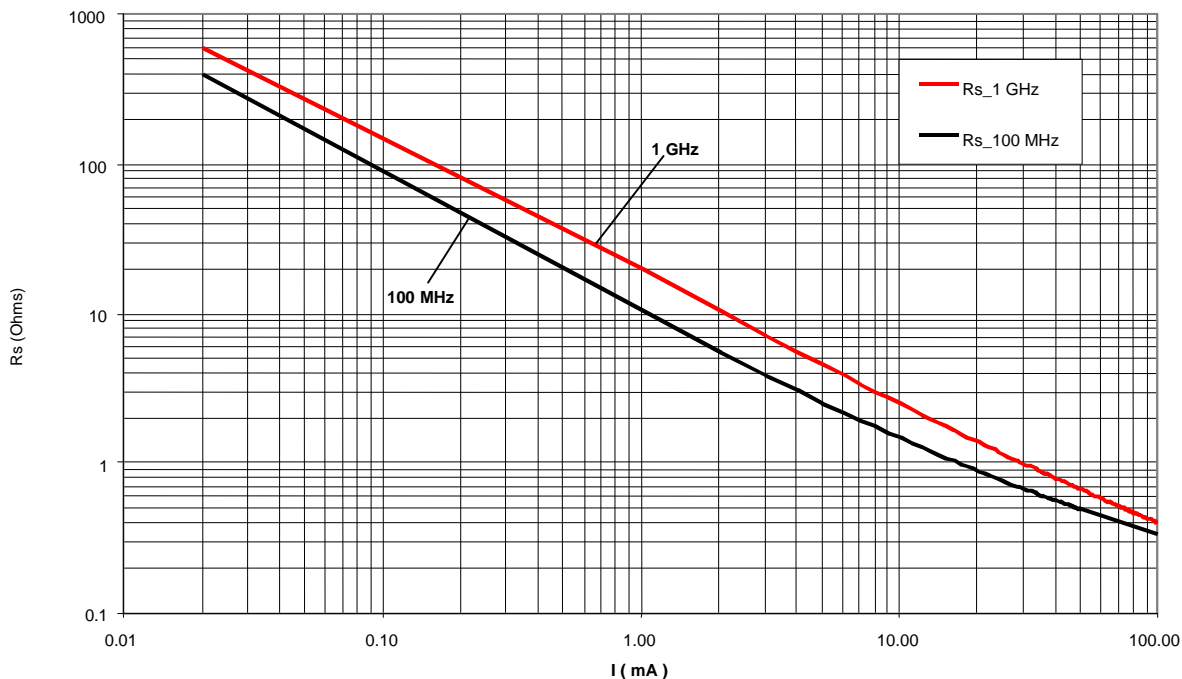

MA4P7470F-1072T Rp vs Voltage

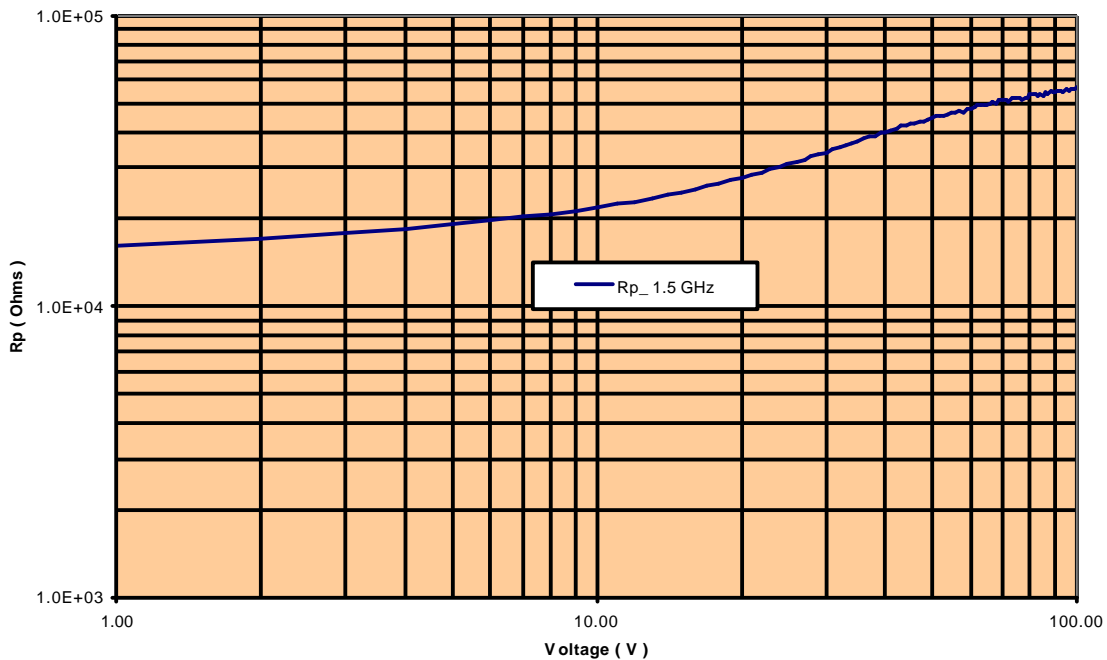

M/A-COM Inc. and its affiliates reserve the right to make changes to the product(s) or information contained herein without notice.

Visit [www.macom.com](http://www.macom.com) for additional data sheets and product information.

- North America: Tel. (800) 366-2266
- Asia/Pacific: Tel.+81-44-844-8296, Fax +81-44-844-8298
- Europe: Tel. +44 (1908) 574 200, Fax+44 (1908) 574 300

Typical Electrical Performance

MA4P7470F-1072T Ct vs Voltage

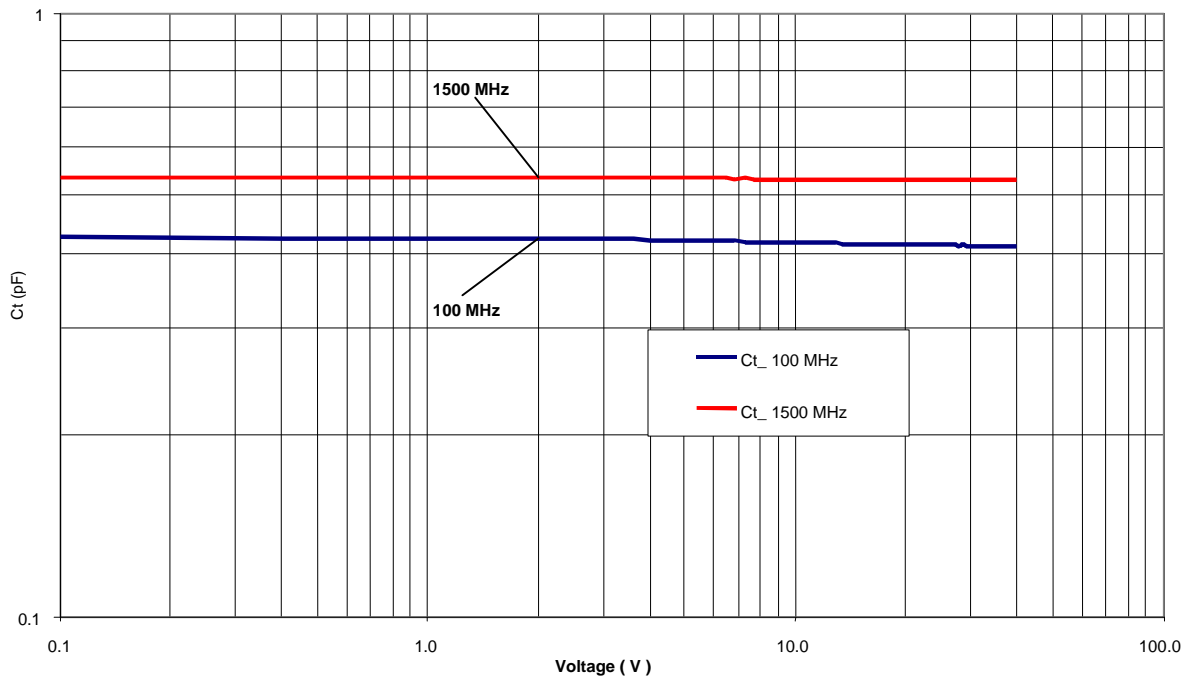

MA4P7470F-1072T Ls vs Frequency

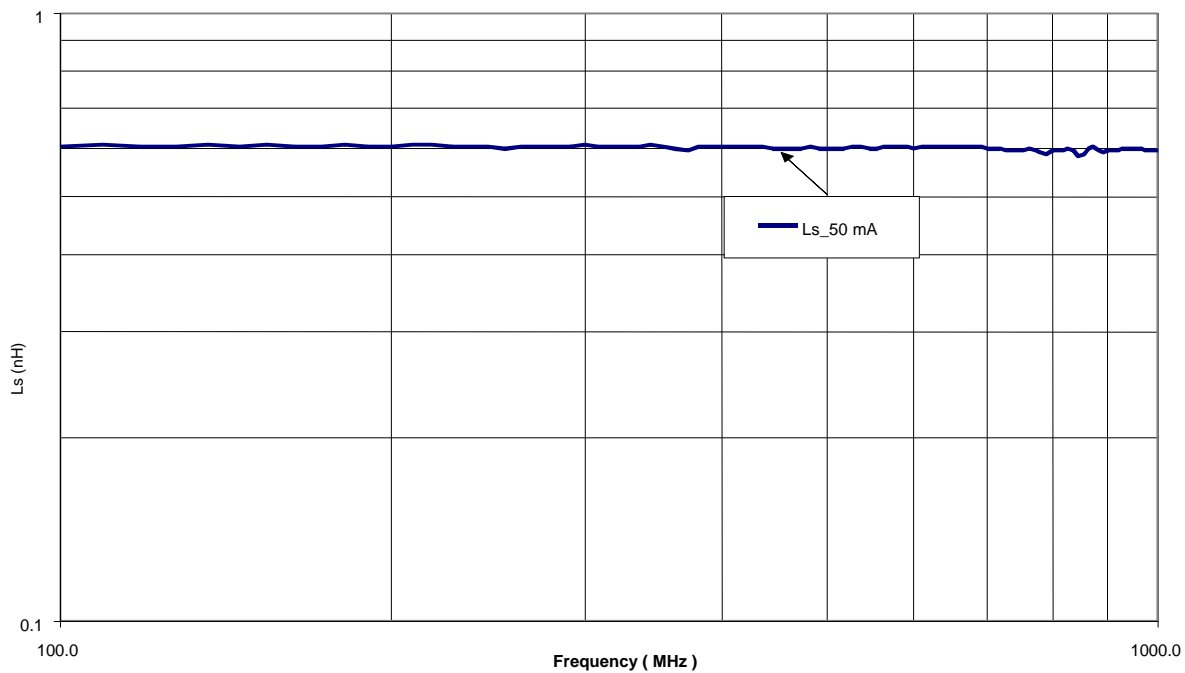

M/A-COM Inc. and its affiliates reserve the right to make changes to the product(s) or information contained herein without notice.

Visit [www.macom.com](http://www.macom.com) for additional data sheets and product information.

- North America: Tel. (800) 366-2266
- Asia/Pacific: Tel.+81-44-844-8296, Fax +81-44-844-8298
- Europe: Tel. +44 (1908) 574 200, Fax+44 (1908) 574 300



Typical Non-Magnetic Performance

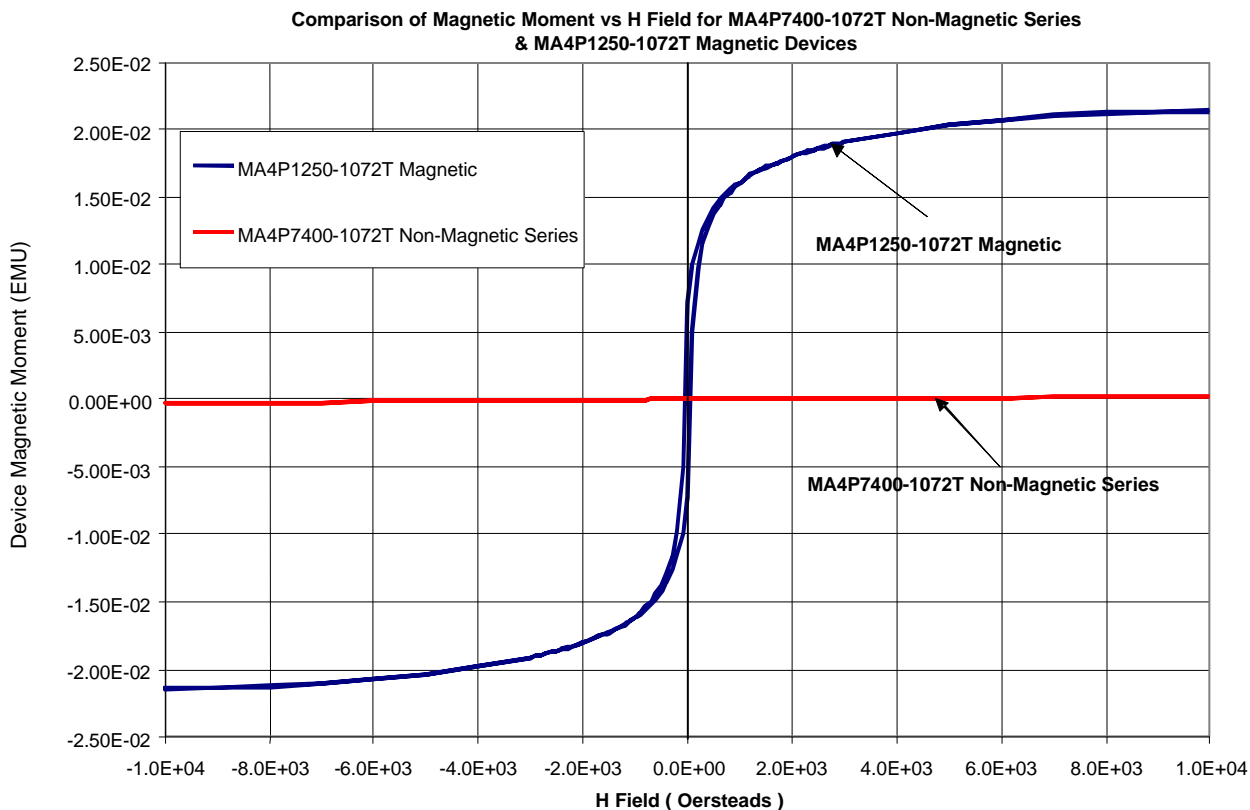

Table 1 - Typical Magnetic Properties of Non-Magnetic MA4P7470F-1072T Device Vs. Conventional MA4P1250-1072T Magnetic Device

Magnetic Property	MA4P7470F-1072T Value	MA4P1250-1072T Value
Saturation Moment (EMU) @ H = H <sub>MAX</sub> Oersteds	2.3 x E-4	2.1 x E-2
Remanance Moment (EMU) @ H = 0 Oersteds	4.2 x E-8	7.1 x E-3
Coercivity (Oersteds) @ EMU = 0 Moment	1	59.2