

M/A-COM 0.4W Variable Distributed Amplifier

1.0 – 15.0 GHz

Preliminary Information

MAAMGM0003-DIE

Features

- ◆ 1.0 to 15.0 GHz Operation
- ◆ 0.4 Watt Saturated Output Power Level
- ◆ Variable Gain Control
- ◆ Select at Test Biasing
- ◆ Variable Drain Voltage (5-8V) Operation
- ◆ Self-Aligned MSAG[®] MESFET Process

1.0 - 15.0 GHz GaAs MMIC Amplifier

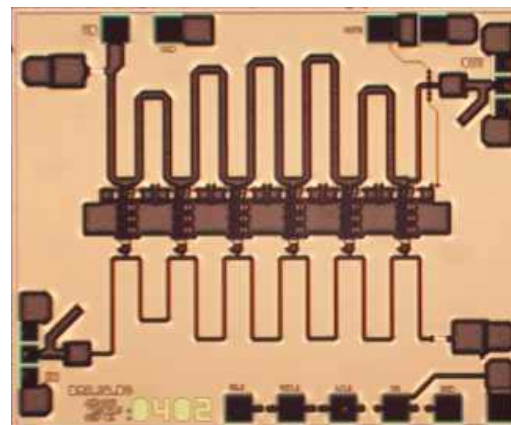

Primary Applications

- ◆ EW
- ◆ Radar

Description

The MAAMGM0003-Die is a 0.4W Distributed Amplifier with on-chip bias networks and variable gain control. This product is fully matched to 50 ohms on both the input and output. The MMIC can be used as a broadband amplifier stage or as a driver stage in high power applications.

Each device is 100% RF tested on wafer to ensure performance compliance. The part is fabricated using M/A-COM's repeatable, high performance and highly reliable GaAs Multifunction Self-Aligned Gate (MSAG[®]) MESFET Process. This process features silicon oxyni-

Electrical Characteristics: $T_B = 40^\circ\text{C}^1$, $Z_0 = 50\Omega$, $V_{DD} = 7\text{V}$, $V_{GG} = -2\text{V}$, $P_{in} = 20\text{ dBm}$

Parameter	Symbol	Typical	Units
Bandwidth	f	1.0-15.0	GHz
Output Power	P_{OUT}	26	dBm
Power Added Efficiency	PAE	11	%
1-dB Compression Point	P_{1dB}	25	dBm
Small Signal Gain	G	7.5	dB
Output TOI	OTOI	39	dBm
Input VSWR	VSWR	2:1	
Gate Current	I_{GG}	< 8	mA
Drain Current	I_{DD}	< 480	mA

1. T_B = MMIC Base Temperature

Maximum Operating Conditions ¹

Parameter	Symbol	Absolute Maximum	Units
Input Power	P_{IN}	25	dBm
Drain Voltage	V_{DD}	+8.0	V
Gate Voltage, Primary	V_{GG}	-3.0	V
Gate Voltage, Select at Test	HI, MID, LO	-5.0	V
Gate Voltage, Control	GATE	0	V
Quiescent Drain Current (No RF)	I_{DQ}	420	mA
Quiescent DC Power Dissipation (No RF)	P_{DISS}	3.4	W
Junction Temperature	T_J	180	°C
Storage Temperature	T_{STG}	-55 to +150	°C

1. Operation outside of these ranges may reduce product reliability. Operation at other than the typical values may result in performance outside the guaranteed limits.

Recommended Operating Conditions

Characteristic	Symbol	Min	Typ	Max	Unit
Drain Voltage	V_{DD}	5	7	8	V
Gate Voltage, Primary	V_{GG}	-2.4	-2.0	-1.6	V
Gate Voltage, Select at Test	HI, MID, LO		-5.0		V
Gate Voltage, Control	GATE	-4	0	0	V
Input Power	P_{IN}			23	dBm
Junction Temperature	T_J			150	°C
MMIC Base Temperature	T_B			Note 2	°C

2. Maximum MMIC Base Temperature = 150°C — 25.8 °C/W * V_{DD} * I_{DQ}

Operating Instructions

This device is static sensitive. Please handle with care. To operate the device, follow these steps.

1. Apply $V_{GG} = -2$ V, $V_{DD} = 0$ V.
2. Ramp V_{DD} to desired voltage, typically 5 V.
3. Adjust V_{GG} to set I_{DQ} , (approximately @ -2 V).
4. Set RF input.
5. Power down sequence in reverse. Turn gate voltage off last.



Specifications subject to change without notice.

Customer Service: Tel. (888)-563-3949

Email: macom_adbu_ics@tycoelectronics.com

- North America: Tel. (800) 366-2266
- Asia/Pacific: Tel. +81-44-844-8296, Fax +81-44-844-8298
- Europe: Tel. +44 (1344) 869 595, Fax+44 (1344) 300 020

tyco / Electronics

MACOM

Visit www.macom.com for additional data sheets and product information.

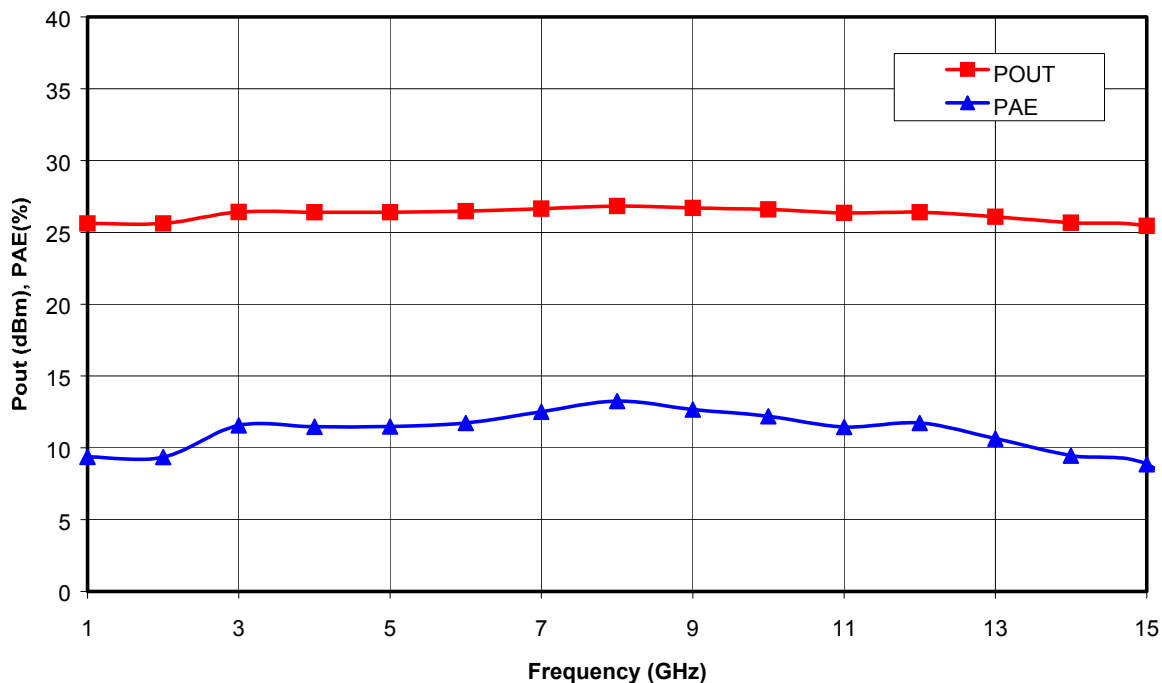

Figure 1. Output Power and Power Added Efficiency vs. Frequency at $V_{DD} = 7V$, $P_{in} = 20dBm$.

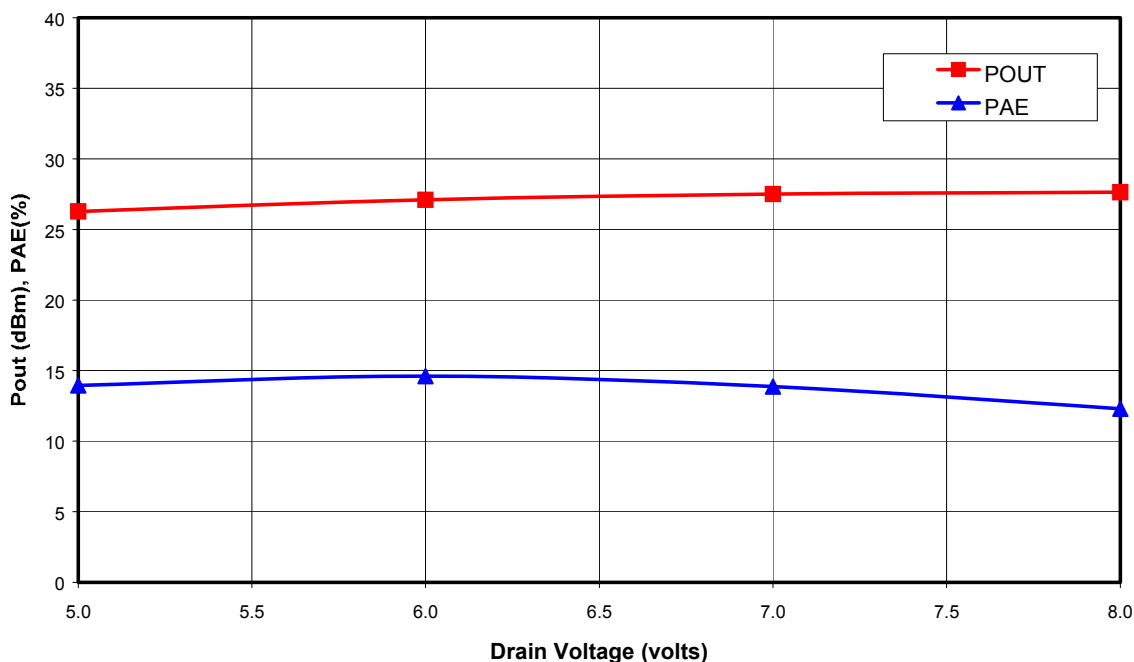

Figure 2. Saturated Output Power and Power Added Efficiency vs. Drain Voltage at $f_o = 9 GHz$.

Specifications subject to change without notice.

Customer Service: Tel. (888)-563-3949

Email: macom_adbu_ics@tycoelectronics.com

■ North America: Tel. (800) 366-2266

■ Asia/Pacific: Tel.+81-44-844-8296, Fax +81-44-844-8298

■ Europe: Tel. +44 (1344) 869 595, Fax+44 (1344) 300 020

tyco / Electronics

MACOM

Visit www.macom.com for additional data sheets and product information.

0.4W Variable Distributed Amplifier

MAAMGM0003-DIE

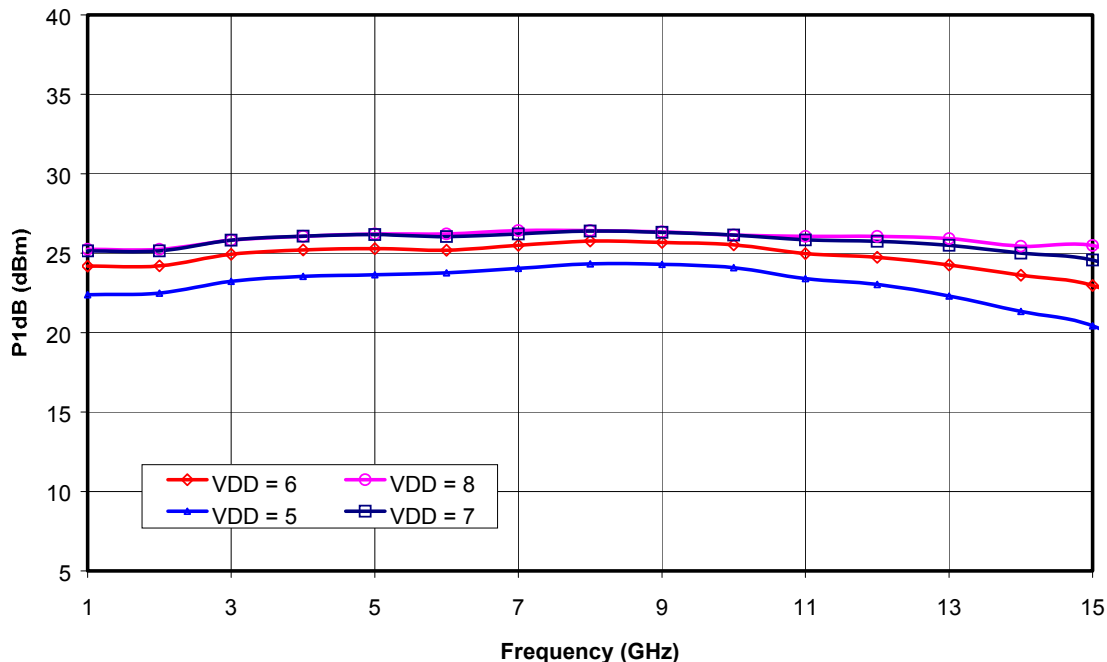

Figure 3. 1dB Compression Point vs. Drain Voltage

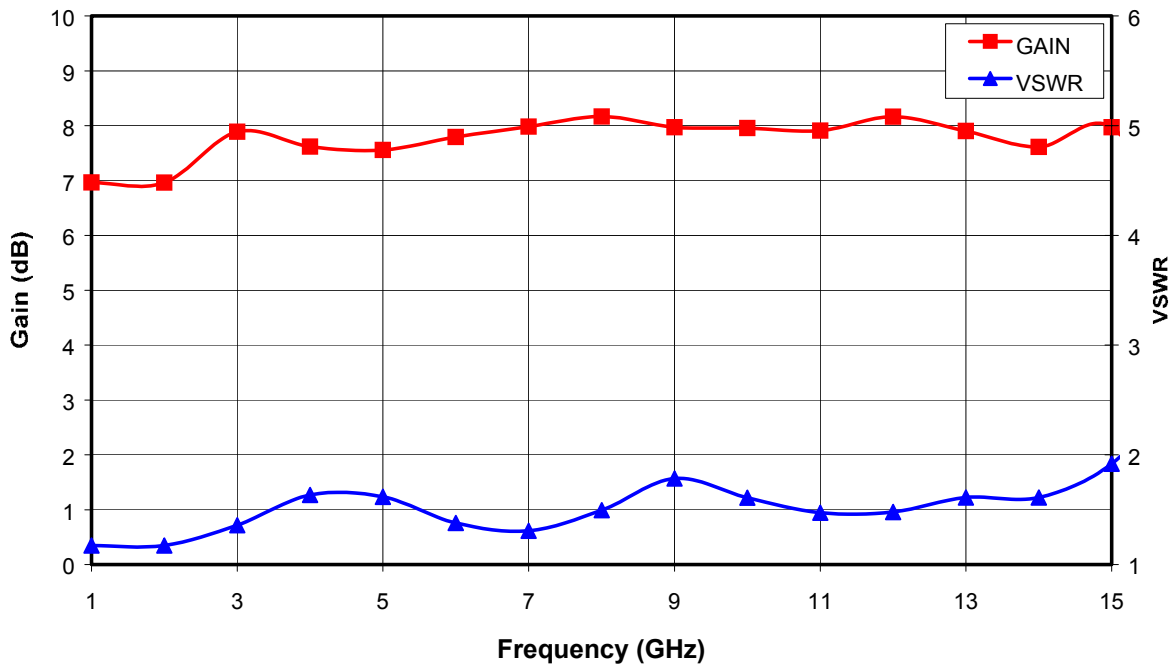

Figure 4. Small Signal Gain and VSWR vs. Frequency at V_{DD} = 7V.

Specifications subject to change without notice.

Customer Service: Tel. (888)-563-3949

Email: macom_adbu_ics@tycoelectronics.com

- North America: Tel. (800) 366-2266
- Asia/Pacific: Tel.+81-44-844-8296, Fax +81-44-844-8298
- Europe: Tel. +44 (1344) 869 595, Fax+44 (1344) 300 020



Visit www.macom.com for additional data sheets and product information.

0.4W Variable Distributed Amplifier

MAAMGM0003-DIE

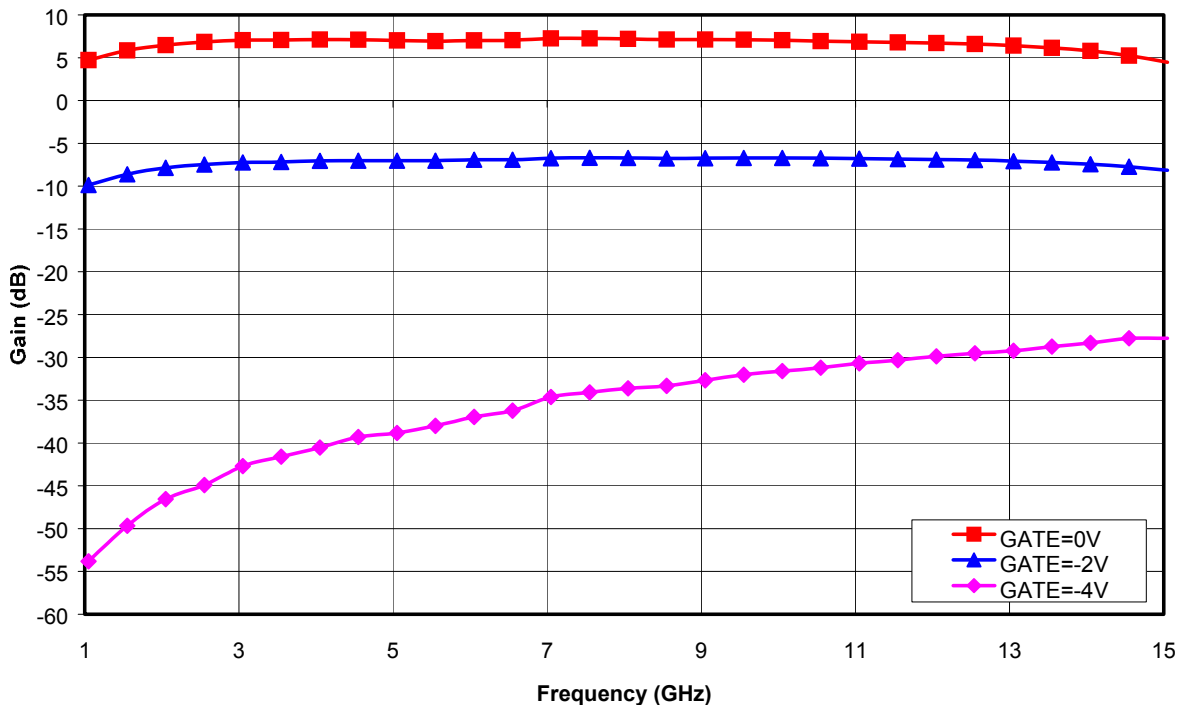

Figure 5. Small Signal Gain vs. Frequency at MID=-5V, V_{DD} = 5V.

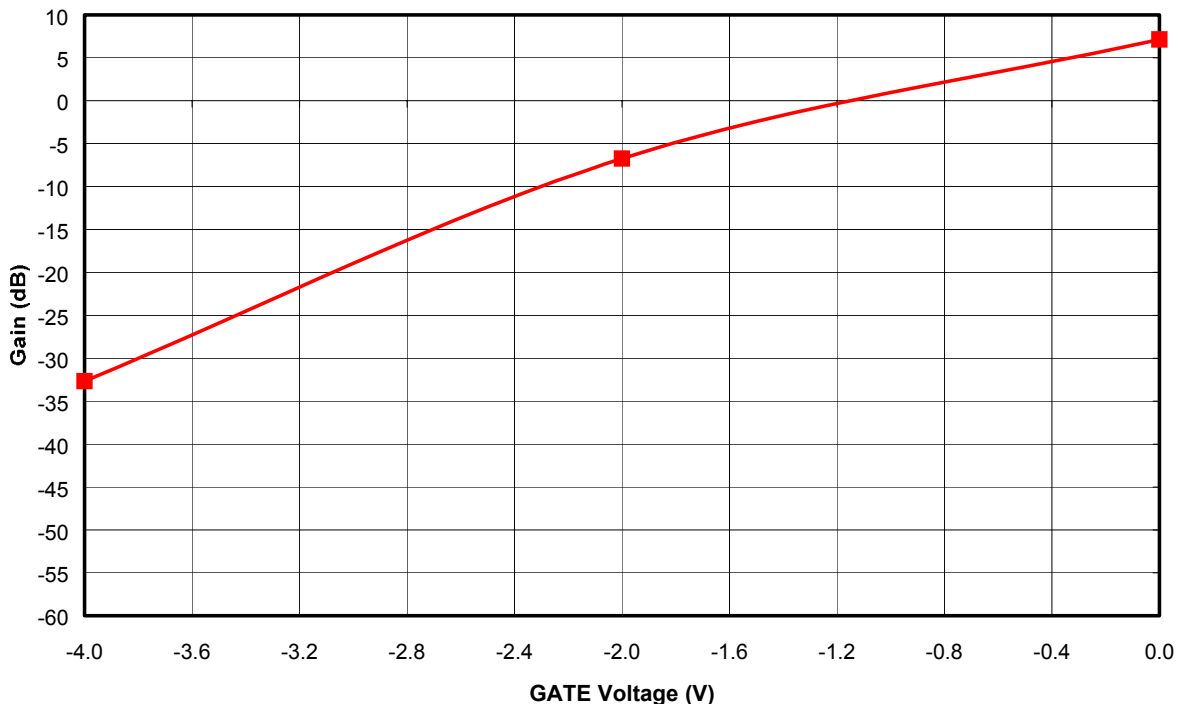

Figure 6. Small Signal Gain vs. GATE Voltage at f₀ = 9.05 GHz, MID=-5V, V_{DD} = 5V.

Specifications subject to change without notice.

Customer Service: Tel. (888)-563-3949

Email: macom_adbu_ics@tycoelectronics.com

- North America: Tel. (800) 366-2266
- Asia/Pacific: Tel.+81-44-844-8296, Fax +81-44-844-8298
- Europe: Tel. +44 (1344) 869 595, Fax+44 (1344) 300 020



Visit www.macom.com for additional data sheets and product information.

Mechanical Information

Chip Size: 2.98 x 2.48 x 0.075 mm (118 x 98 x 3 mils)

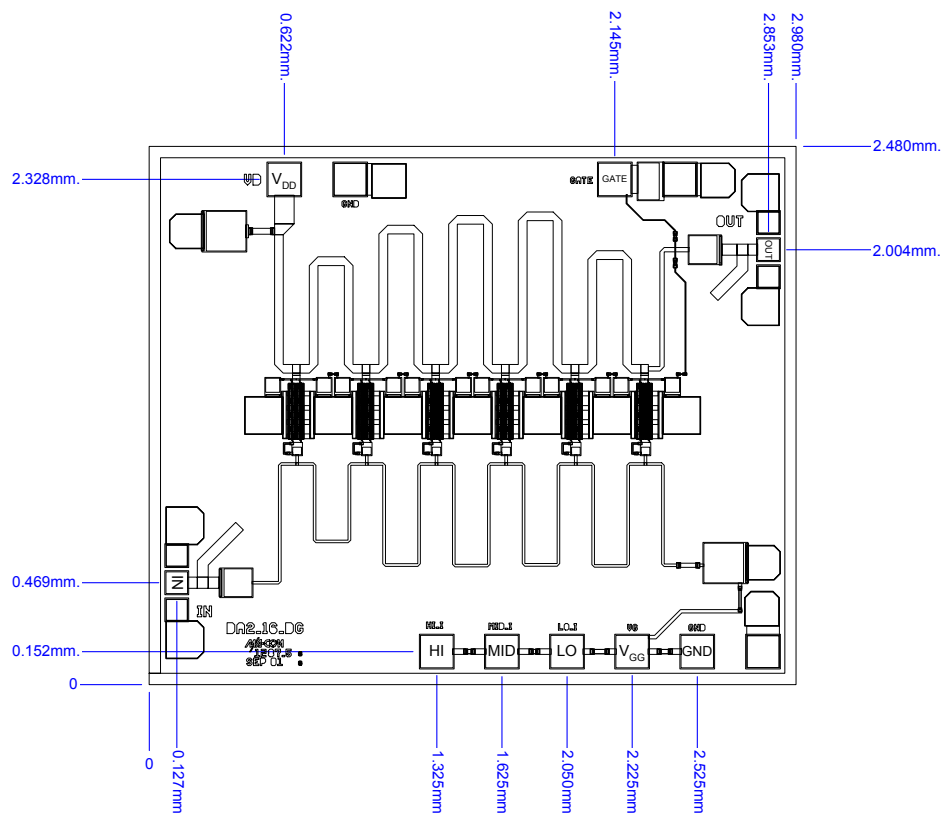

Figure 7. Die Layout

Bond Pad Dimensions

Pad	Size (μm)	Size (mils)
RF In and Out	100 x 200	4 x 8
DC Drain Supply Voltage VDD	150 x 150	6 x 6
DC Gate Supply Voltage VGG	150 x 150	6 x 6

Specifications subject to change without notice.

Customer Service: Tel. (888)-563-3949

Email: macom_adbu_ics@tycoelectronics.com

- North America: Tel. (800) 366-2266
- Asia/Pacific: Tel. +81-44-844-8296, Fax +81-44-844-8298
- Europe: Tel. +44 (1344) 869 595, Fax+44 (1344) 300 020

tyco / Electronics

MACOM

Visit www.macom.com for additional data sheets and product information.

0.4W Variable Distributed Amplifier

MAAMGM0003-DIE

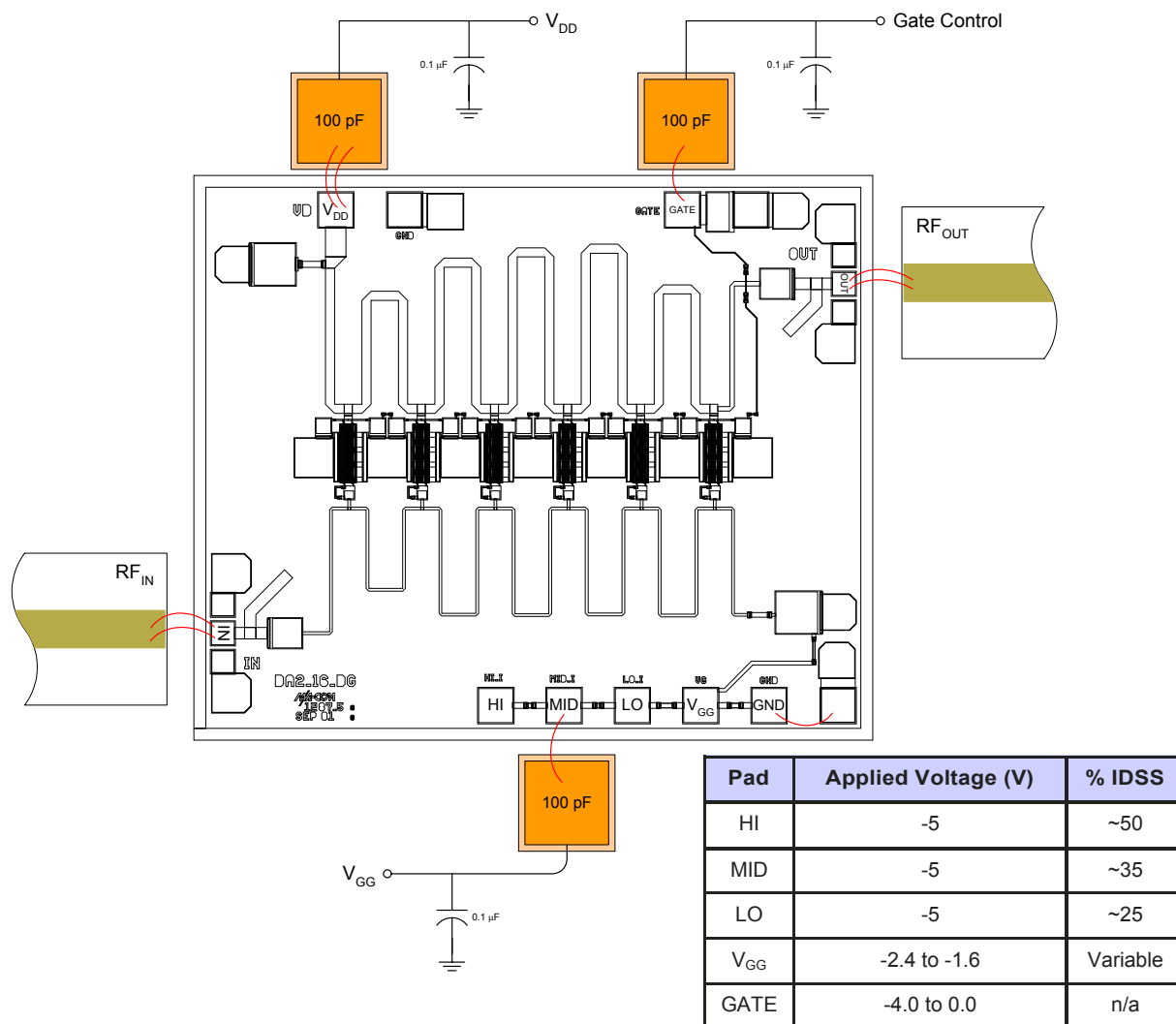

Figure 8. Recommended bonding diagram for pedestal mount. Support circuitry typical of MMIC characterization fixture for CW testing.

Assembly Instructions:

Die attach: Use AuSn (80/20) 1-2 mil. preform solder. Limit time @ 300 °C to less than 5 minutes.

Wirebonding: Bond @ 160 °C using standard ball or thermal compression wedge bond techniques. For DC pad connections, use either ball or wedge bonds. For best RF performance, use wedge bonds of shortest length, although ball bonds are also acceptable.

Biasing Note: Must apply negative bias to V_{GG} before applying positive bias to V_{DD} to prevent damage to amplifier.

Specifications subject to change without notice.

Customer Service: Tel. (888)-563-3949

Email: macom_adbu_ics@tycoelectronics.com

- **North America:** Tel. (800) 366-2266
- **Asia/Pacific:** Tel.+81-44-844-8296, Fax +81-44-844-8298
- **Europe:** Tel. +44 (1344) 869 595, Fax+44 (1344) 300 020

tyco / Electronics

MACOM

Visit www.macom.com for additional data sheets and product information.