

**Features**

- 75 Ohm
- SMT unit
- Low Cost, Low Profile
- RoHS\* Compliant

**Description**

M/A-COM's MAFL-007654-CD0A10 is a low cost, low profile diplex filter designed for use in CATV set-top-box and cable modem applications. Technology used in this design is patent pending.

**Functional Schematic**

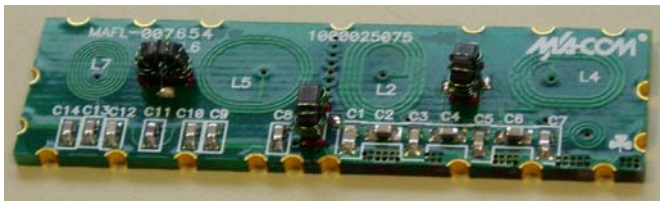
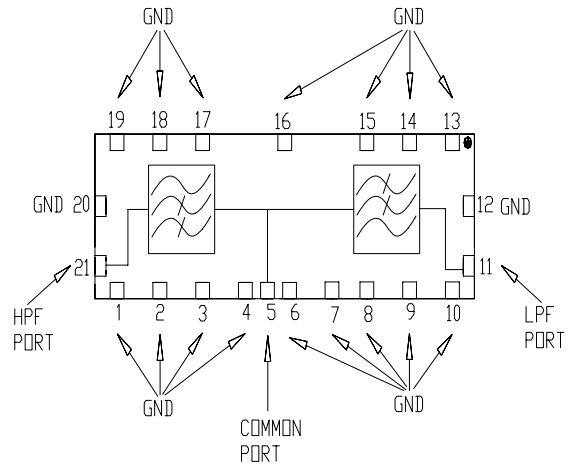

**Pin Configuration**

Function	Pin Number
Common Port	5
Low Pass Port	11
Output Port	21
Ground	1-4, 6-10, 12-20
Not connected	-

**Absolute Maximum Ratings** <sup>1,2</sup>

Parameter	Absolute Maximum
RF Power	250mW
DC Current	30mA
Operating Temperature	-40°C to +85°C
Storage Temperature	-40°C to +85°C

1. Exceeding any one or combination of these limits may cause permanent damage to this device.
2. M/A-COM does not recommend sustained operation near these survivability limits.

***This ADVANCE Data Sheet contains information regarding a product M/A-COM is considering for development. Performance is based on simulated results or target specifications. Commitment to produce in volume is not guaranteed.***

\* Restrictions on Hazardous Substances, European Union Directive 2002/95/EC.

**SM-161 Case Style**

Sm-161 Case Style

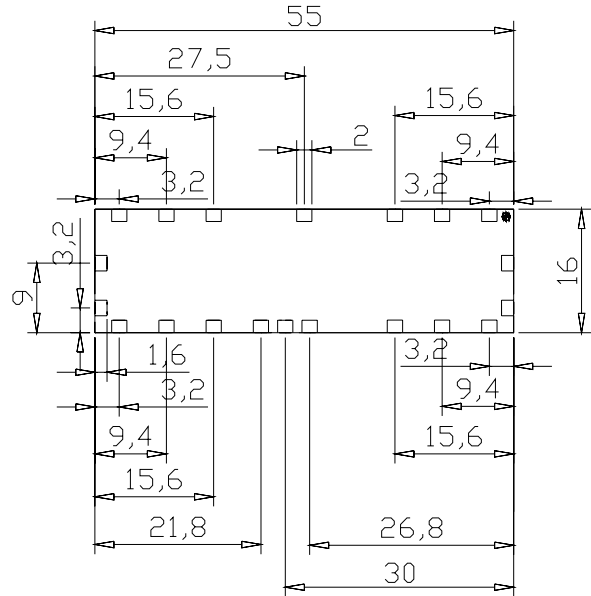
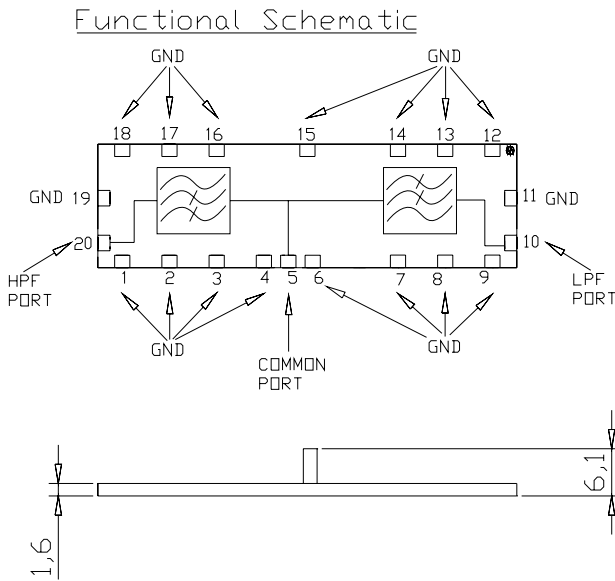

Dimensions in mm. Tolerance: .x ± 0.1, .xx ± 0.05

**Recommended PCB Configuration**

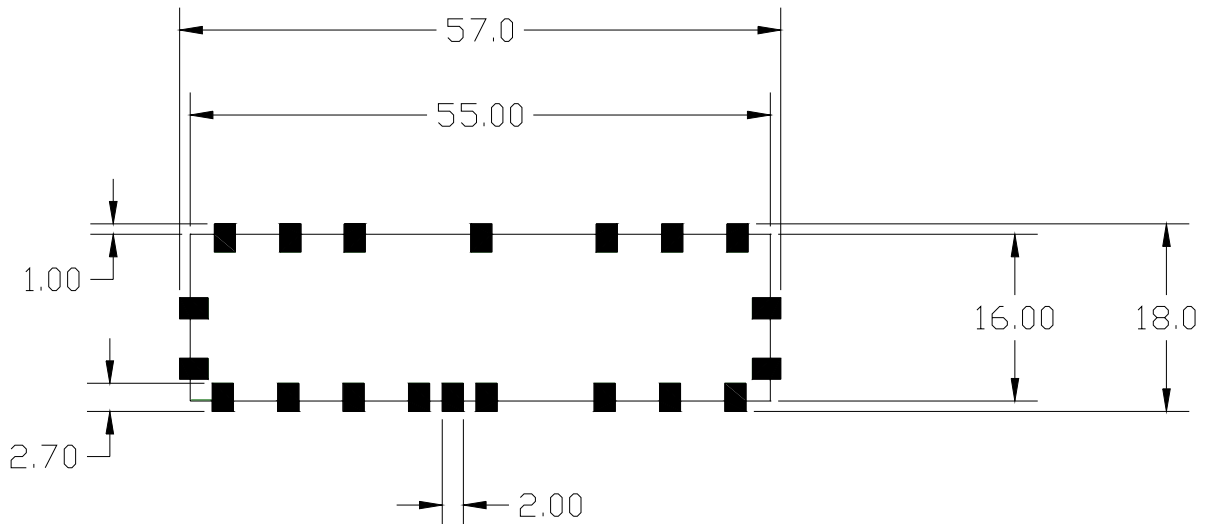

Dimensions in mm. Tolerance: .x ± 0.1, .xx ± 0.05

CATV Diplex Filter  
5 - 42 / 54 - 1000MHz

MAFL-007654-CD0A10  
V1P

**Electrical Specifications:  $T_A = 25^\circ\text{C}$ ,  $Z_0 = 75\Omega$  <sup>1</sup>**

Parameter	Test Conditions	Units	Min	Typ	Max
Frequency Range	5 - 42MHz / 54 - 1000MHz				
Insertion Loss	5 - 42MHz	dB	-	-0.5	-1.1
Insertion Loss	54 - 60MHz 60 - 1000MHz	dB dB	- -	-1.1 -0.5	-1.3 -1.1
Filter Isolation	5 - 39.5MHz 39.5 - 42MHz	dB dB	-55 -48	-62 -55	- -
Filter Isolation	54 - 60MHz 60 - 500MHz 500 - 860MHz 860 - 1000MHz	dB dB db dB	-53 -55 -50 -45	-55 -58 -55 -50	- - - -
Input Return Loss	5 - 42MHz	dB	-14	-17	-
Input Return Loss	54 - 64MHz 64 - 74MHz 74 - 650MHz 650 - 1000MHz	dB dB dB dB	-10 -12 -15 -14	-14 16 20 16	- - - -

**Note:** Performance is target specifications based on a sample batch of 33 units.

**Typical Performance Curves**

**Input Return Loss**

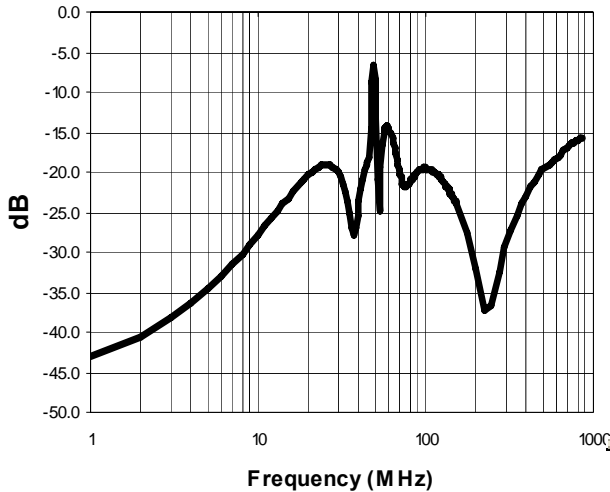

**Filter Isolation**

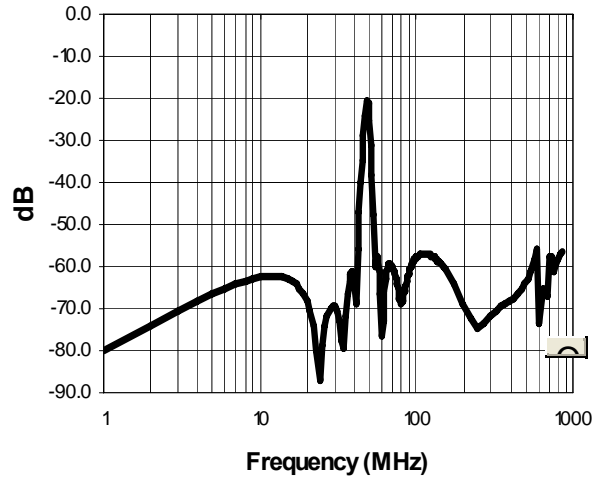

**Low Pass Filter Insertion Loss**

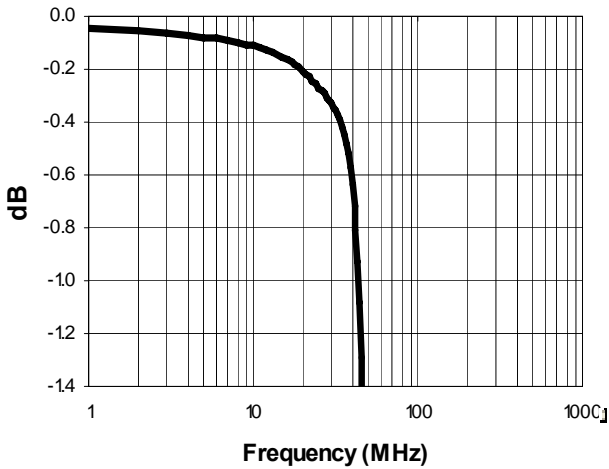

**High Pass Filter Insertion Loss**

