

# Broadband CATV Diplexer

V1

## 5 – 1000 MHz

MAFLCT0032

MAFLCT0032

### Features

- 75 ohm
- SMT unit
- Excellent temperature stability
- Excellent repeatability

### Description

M/A-COM's MAFLCT0032 is a low cost, SMT diplex filter unit designed for CATV FTTx, Home Gateway and Distribution applications. The technology used in this design is patent pending.



### Electrical Specifications @ 25°C, 75 ohm

Parameter	Test Conditions	Units	Min.	Typ.	Max.
Frequency Range:	5-30 / 46-1000MHz				
Insertion Loss <sup>1</sup>	5-30 MHz 46-1000 MHz	dB		0.7 0.75	0.9 0.9
Isolation	5-30 MHz 31-45 MHz 46-1000 MHz	dB	45 15 45	47 20 46	
Input Port Return Loss	5-30 MHz 46-1000 MHz	dB	17 17	18 18	

<sup>1</sup> Flatness is included in the insertion loss specification

M/A-COM Inc. and its affiliates reserve the right to make changes to the product(s) or information contained herein without notice

Visit [www.macom.com](http://www.macom.com) for additional data sheets and product information

■ North America: Tel. (800) 366-266, Fax (800) 618-8883  
 ■ Asia/Pacific: Tel.+ 81-44-844-8296, Fax+81-44-844-8298  
 ■ Europe: Tel. +44(1908) 574 200, Fax +44(1908) 574 300

Typical Performance @ +25° C

Input Return Loss

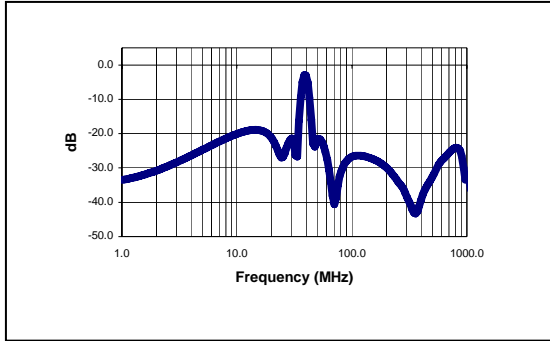

Isolation

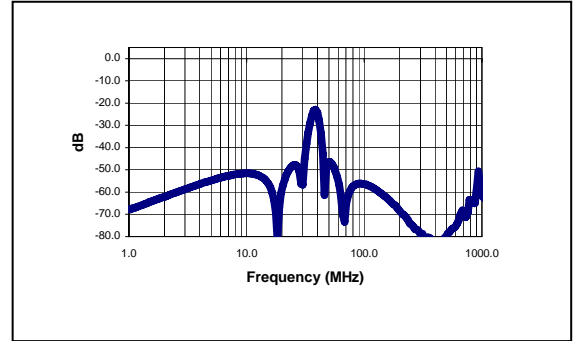

High Pass Filter Insertion Loss

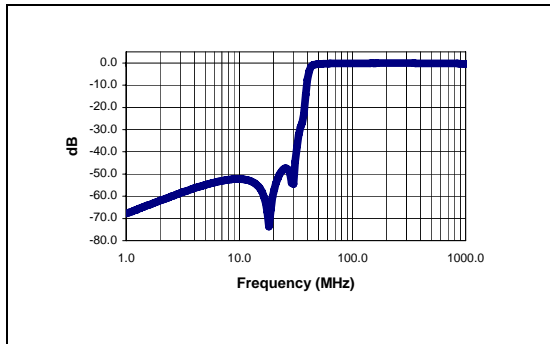

Low Pass Filter Insertion Loss

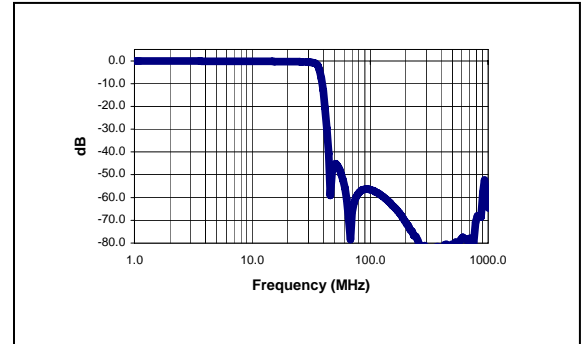

Absolute Maximum Ratings <sup>1</sup>

	Absolute Maximum
RF Power	250 mW
DC Current	30 mA
Operating/Storage Temperature	-40° C to +85° C

<sup>1</sup> Exceeding one or a combination of these settings may cause permanent damage to the unit

M/A-COM Inc. and its affiliates reserve the right to make changes to the product(s) or information contained herein without notice

Visit [www.macom.com](http://www.macom.com) for additional data sheets and product information

■ North America: Tel. (800) 366-266, Fax (800) 618-8883  
 ■ Asia/Pacific: Tel.+ 81-44-844-8296, Fax+81-44-844-8298  
 ■ Europe: Tel. +44(1908) 574 200, Fax +44(1908) 574 300



**SM-160 Case Style**

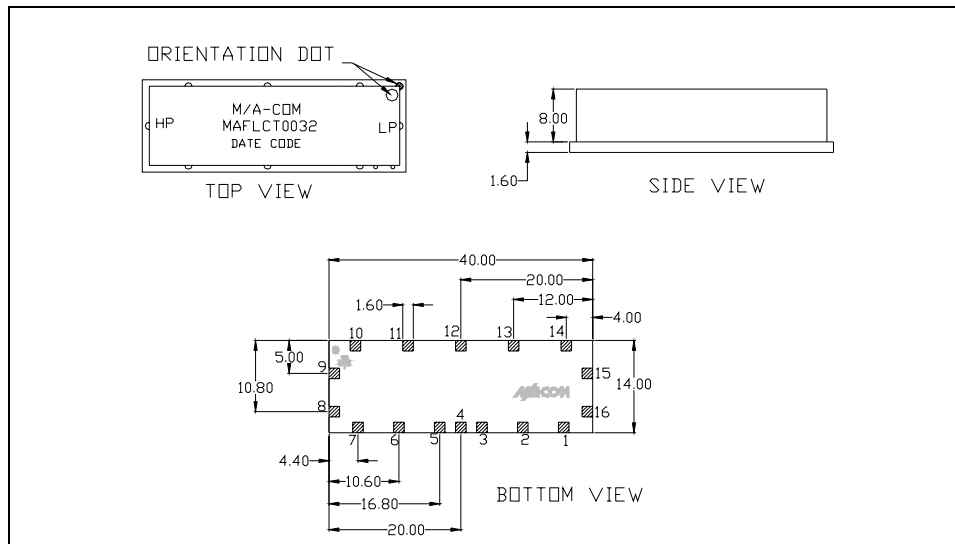

**Suggested Footprint**

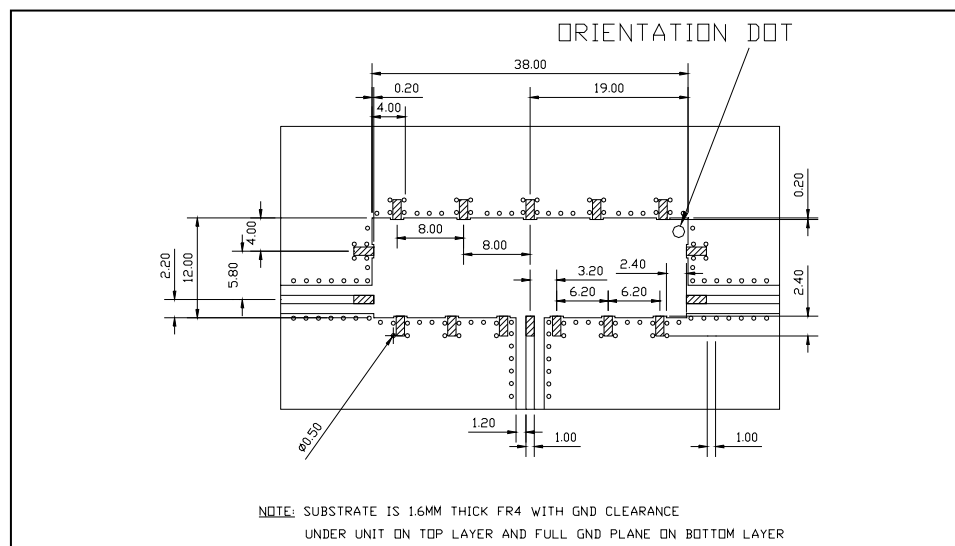

M/A-COM Inc. and its affiliates reserve the right to make changes to the product(s) or information contained herein without notice

Visit [www.macom.com](http://www.macom.com) for additional data sheets and product information

- North America: Tel. (800) 366-266, Fax (800) 618-8883
- Asia/Pacific: Tel.+ 81-44-844-8296, Fax+81-44-844-8298
- Europe: Tel. +44(1908) 574 200, Fax +44(1908) 574 300

**Functional Schematic**

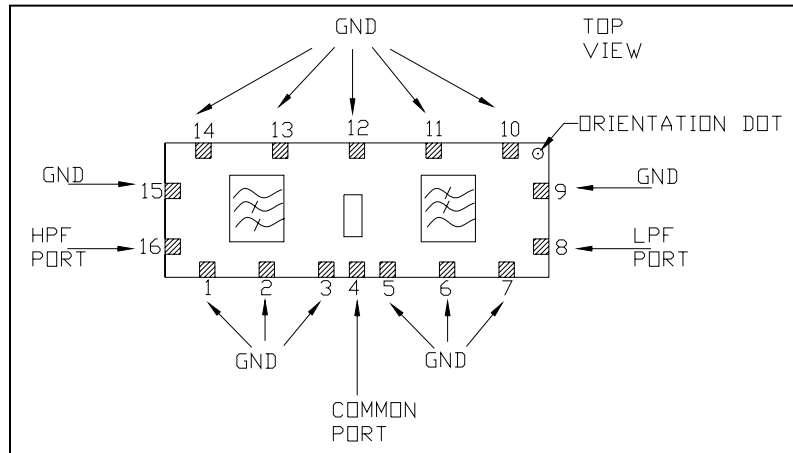

**Pin Configuration**

Function	Pin No.
Common Port	4
Low Pass Port	8
High Pass Port	16
Ground	1-3, 5 - 7, 10 - 15
Not Connected	-

Additional Specifications	Group Delay (nSec)	
	TYP	MAX
28.5 – 30MHz	5ns	10ns
46 – 47.5MHz	10ns	15ns
55.25 – 58.83MHz	5ns	10ns
61.25 – 64.83MHz	5ns	10ns

M/A-COM Inc. and its affiliates reserve the right to make changes to the product(s) or information contained herein without notice  
 Visit [www.macom.com](http://www.macom.com) for additional data sheets and product information

■ North America: Tel. (800) 366-266, Fax (800) 618-8883  
 ■ Asia/Pacific: Tel.+ 81-44-844-8296, Fax+81-44-844-8298  
 ■ Europe: Tel. +44(1908) 574 200, Fax +44(1908) 574 300