

# 2 x 1.5W, Stereo Class D Audio Subsystem with DirectDrive Headphone Amplifier

## General Description

The MAX9775/MAX9776 combine a high-efficiency Class D, stereo/mono audio power amplifier with a mono DirectDrive™ receiver amplifier and a stereo DirectDrive headphone amplifier.

Maxim's 3rd-generation, ultra-low-EMI, Class D audio power amplifiers provide Class AB performance with Class D efficiency. The MAX9775/MAX9776 deliver 1.5W per channel into a 4Ω load from a 5V supply and offer efficiencies up to 79%. Active emissions limiting circuitry and spread-spectrum modulation greatly reduce EMI, eliminating the need for output filtering found in traditional Class D devices.

The MAX9775/MAX9776 utilize a fully differential architecture, a full-bridged output, and comprehensive click-and-pop suppression. A 3D stereo enhancement function allows the MAX9775 to widen the stereo sound field immersing the listener in a cleaner, richer sound experience than typically found in portable applications. The devices utilize a flexible, user-defined mixer architecture that includes an input mixer, volume control, and output mixer. All control is done through I<sup>2</sup>C.

The mono receiver amplifier and stereo headphone amplifier use Maxim's patented† DirectDrive architecture that produces a ground-referenced output from a single supply, eliminating the need for large DC-blocking capacitors, saving cost, space, and component height.

The MAX9775/MAX9776 are available in a 32-pin TQFN (5mm x 5mm) or a 32-bump UCSP™ (3mm x 3mm) package and specified over the extended -40°C to +85°C temperature range.

## Applications

Cell Phones  
Portable Multimedia Players  
Handheld Gaming Consoles

†U.S. Patent# 7,061,327

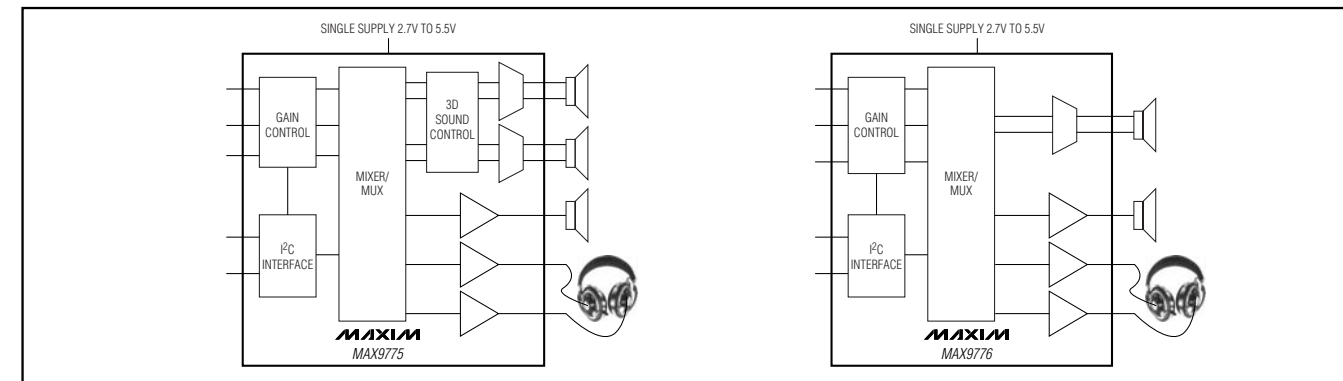

## Features

- ◆ Unique Spread-Spectrum Modulation and Active Emissions Limiting Significantly Reduces EMI
- ◆ 3D Stereo Enhancement (MAX9775 Only)
- ◆ Up to 3 Stereo Inputs
- ◆ 1.5W Stereo Speaker Output (4Ω, V<sub>DD</sub> = 5V)
- ◆ 50mW Mono Receiver/Stereo Headphone Outputs (32Ω, V<sub>DD</sub> = 3.3V)
- ◆ High PSRR (68dB at 217Hz)
- ◆ 79% Efficiency (V<sub>DD</sub> = 3.3V, R<sub>L</sub> = 8Ω, P<sub>OUT</sub> = 470mW)
- ◆ I<sup>2</sup>C Control—Input Configuration, Volume Control, Output Mode
- ◆ Click-and-Pop Suppression
- ◆ Low Total Harmonic Distortion (0.03% at 1kHz)
- ◆ Current-Limit and Thermal Protection

## Ordering Information

PART	PIN-PACKAGE	PKG CODE	CLASS D AMPLIFIER
MAX9775ETJ+*	32 TQFN-EP**	T3255-4	Stereo
MAX9775EBX+T*	32 UCSP-32	B36-4	Stereo
MAX9776ETJ+	32 TQFN-EP**	T3255-4	Mono
MAX9776EBX+T	32 UCSP-32	B36-4	Mono

**Note:** All devices are specified over the -40°C to +85°C operating temperature range.

+Denotes lead-free package.

\*Future product—contact factory for availability.

\*\*EP = Exposed pad.

Pin Configurations appear at end of data sheet.

UCSP is a trademark of Maxim Integrated Products, Inc.

## Simplified Block Diagrams

# 2 x 1.5W, Stereo Class D Audio Subsystem with DirectDrive Headphone Amplifier

## ABSOLUTE MAXIMUM RATINGS

V <sub>DD</sub> to GND	6V	Duration of Short Circuit Between	
PV <sub>DD</sub> to PGND	6V	OUT <sub>+</sub> and OUT <sub>-</sub>	Continuous
CPV <sub>DD</sub> to CPGND	6V	Duration of HP <sub>-</sub> , OUT <sub>-</sub> Short Circuit to	
CPV <sub>SS</sub> to CPGND	-6V to +0.3V	GND or PV <sub>DD</sub>	Continuous
V <sub>SS</sub> to CPGND	-6V to +0.3V	Continuous Power Dissipation (T <sub>A</sub> = +70°C)	
C1N	(CPV <sub>SS</sub> - 0.3V) to (CPGND + 0.3V)	32-Bump (3mm x 3mm) UCSP Multilayer Board	(derate 17.0mW/°C above +70°C) 1360.5mW
C1P	(CPGND - 0.3V) to (CPV <sub>DD</sub> + 0.3V)	32-Pin (5mm x 5mm) TQFN Single-Layer Board	(derate 21.3mW/°C above +70°C) 1702.1mW
HPL, HPR to GND	(CPV <sub>SS</sub> - 0.3V) to (CPV <sub>DD</sub> + 0.3V)	32-Pin TQFN Multilayer Board (derate 34.5mW/°C above +70°C)	2758.6mW
GND to PGND and CPGND	±0.3V	Junction Temperature	+150°C
V <sub>DD</sub> to PV <sub>DD</sub> and CPV <sub>DD</sub>	±0.3V	Operating Temperature Range	-40°C to +85°C
SDA, SCL to GND	-0.3V to +6V	Storage Temperature Range	-65°C to +150°C
All other pins to GND	-0.3V to (V <sub>DD</sub> + 0.3V)	Lead Temperature (soldering, 10s)	+300°C
Continuous Current In/Out of PV <sub>DD</sub> , PGND, CPV <sub>DD</sub> , CPGND, OUT <sub>+</sub> , HPR, and HPL	±800mA		
Continuous Input Current CPV <sub>SS</sub>	±260mA		
Continuous Input Current (all other pins)	±20mA		

Stresses beyond those listed under "Absolute Maximum Ratings" may cause permanent damage to the device. These are stress ratings only, and functional operation of the device at these or any other conditions beyond those indicated in the operational sections of the specifications is not implied. Exposure to absolute maximum rating conditions for extended periods may affect device reliability.

## ELECTRICAL CHARACTERISTICS

(V<sub>DD</sub> = PV<sub>DD</sub> = CPV<sub>DD</sub> = 3.3V, GND = PGND = CPGND = 0V,  $\overline{\text{SHDN}} = \text{V}_{\text{DD}}$ , I<sup>2</sup>C settings (INA gain = +20dB, INB gain = INC gain = 0dB, volume setting = 0dB, mono path gain = 0dB,  $\overline{\text{SHDN}} = 1$ , SSM = 1). Speaker load resistors (R<sub>LS</sub>) are terminated between OUT<sub>+</sub> and OUT<sub>-</sub>, headphone load resistors are terminated to GND, unless otherwise noted. C1 = C2 = C3 = 1μF. T<sub>A</sub> = T<sub>MIN</sub> to T<sub>MAX</sub>, unless otherwise noted. Typical values are at T<sub>A</sub> = +25°C.) (Note 1)

PARAMETER	SYMBOL	CONDITIONS	MIN	TYP	MAX	UNITS	
<b>GENERAL</b>							
Supply Voltage Range	V <sub>DD</sub> , PV <sub>DD</sub> , CPV <sub>DD</sub>	Inferred from PSRR test	2.7		5.5	V	
Quiescent Current (Mono)	I <sub>DD</sub>	Output mode 1, 6, 11 (Rx mode)		6.3	10	mA	
		Output mode 4, 9, 14 (HP mode)		8	12.6		
		Output mode 2, 7, 12 (SP mode)		9.5	15		
		Output mode 3, 8, 13 (SP and HP mode)		12.9	18		
Quiescent Current (Stereo)	I <sub>DD</sub>	Output mode 1, 6, 11 (Rx mode)		7		mA	
		Output mode 4, 9, 14 (HP mode)		9			
		Output mode 2, 7, 12 (SP mode)		16.5			
		Output mode 3, 8, 13 (SP and HP mode)		20			
Mute Current	I <sub>MUTE</sub>	Current in mute (low power)		4.7	10	mA	
Shutdown Current	I <sub>SHDN</sub>	Hard shutdown	$\overline{\text{SHDN}} = \text{GND}$	0.1	10	μA	
		Soft shutdown	See the I <sup>2</sup> C Interface section	8.5	15		
Turn-On Time	t <sub>ON</sub>	Time from shutdown or power-on to full operation		30		ms	
Input Resistance	R <sub>IN</sub>	B and C pair inputs, T <sub>A</sub> = +25°C, VOL = max		17.5	28	41.0	kΩ
		A pair inputs, T <sub>A</sub> = +25°C, +20dB		3.5	5.5	8.0	kΩ
Common-Mode Rejection Ratio	CMRR	T <sub>A</sub> = +25°C, f <sub>IN</sub> = 1kHz (Note 2)	45	50	60	dB	
Input DC Bias Voltage	V <sub>BIAS</sub>	IN <sub>-</sub> inputs	1.12	1.25	1.38	V	

# 2 x 1.5W, Stereo Class D Audio Subsystem with DirectDrive Headphone Amplifier

## ELECTRICAL CHARACTERISTICS (continued)

( $V_{DD} = PV_{DD} = CPV_{DD} = 3.3V$ ,  $GND = PGND = CPGND = 0V$ ,  $\overline{SHDN} = V_{DD}$ , I<sup>2</sup>C settings (INA gain = +20dB, INB gain = INC gain = 0dB, volume setting = 0dB, mono path gain = 0dB,  $\overline{SHDN} = 1$ , SSM = 1). Speaker load resistors ( $R_{LSP}$ ) are terminated between  $OUT_+$  and  $OUT_-$ , headphone load resistors are terminated to GND, unless otherwise noted.  $C1 = C2 = C3 = 1\mu F$ .  $T_A = T_{MIN}$  to  $T_{MAX}$ , unless otherwise noted. Typical values are at  $T_A = +25^\circ C$ .) (Note 1)

PARAMETER	SYMBOL	CONDITIONS		MIN	TYP	MAX	UNITS	
<b>SPEAKER AMPLIFIERS</b>								
Output Offset Voltage	$V_{OS}$	$T_A = +25^\circ C$			±5.5	±23.5	mV	
		$T_{MIN} \leq T_A \leq T_{MAX}$				±40		
Click-and-Pop Level	$K_{CP}$	Peak voltage, $T_A = +25^\circ C$ , A-weighted, 32 samples per second (Notes 2, 3)	Into shutdown		-62		dB	
			Out of shutdown		-60			
			Into mute		-63			
			Out of mute		-62			
Power-Supply Rejection Ratio (Note 3)	PSRR	$T_A = +25^\circ C$	$V_{DD} = 2.7V$ to $5.5V$	48	70		dB	
			$f = 217Hz$ , 100mV <sub>P-P</sub> ripple			68		
			$f = 1kHz$ , 100mV <sub>P-P</sub> ripple			60		
			$f = 20kHz$ , 100mV <sub>P-P</sub> ripple			50		
Output Power (Note 4)	$P_{OUT}$	THD+N = 1%, $T_A = +25^\circ C$	$R_L = 4\Omega$ , $V_{DD} = 5V$		1500		mW	
			$R_L = 8\Omega$ , $V_{DD} = 3.3V$		450			
			$R_L = 8\Omega$ , $V_{DD} = 5V$		1115			
Current Limit					1.6		A	
Total Harmonic Distortion Plus Noise (Note 4)	THD+N	$f = 1kHz$	$R_L = 8\Omega$ , $P_{OUT} = 125mW$		0.03		%	
			$R_L = 4\Omega$ , $P_{OUT} = 250mW$		0.04			
Signal-to-Noise Ratio	SNR	$V_{OUT} = 1.8V_{RMS}$ , $R_L = 8\Omega$ , 3D not active (Note 3)	$BW = 20Hz$ to $20kHz$		81		dB	
			A-weighted		84			
Output Frequency	$f_{OSC}$	Fixed-frequency modulation			1100		kHz	
		Spread-spectrum modulation			1100 ±30			
Efficiency	$\eta$	$P_{OUT} = 470mW$ , $f = 1kHz$ both channels driven, $L = 68\mu H$ in series with $8\Omega$ load			79		%	
Gain	$A_V$				12		dB	
Channel-to-Channel Gain Tracking (Note 5)		$T_A = +25^\circ C$			±1		%	
3D Sound Resistors (Note 5)	$R_{3D}$	Used with 22nF and 2.2nF external capacitors		5	7	9	k $\Omega$	
Crosstalk (Notes 4, 5)		L to R, R to L, $f = 10kHz$ , $R_L = 8\Omega$ , $V_{OUT} = 300mV_{RMS}$			73		dB	

MAX9775/MAX9776

## 2 x 1.5W, Stereo Class D Audio Subsystem with DirectDrive Headphone Amplifier

### ELECTRICAL CHARACTERISTICS (continued)

( $V_{DD} = PV_{DD} = CPV_{DD} = 3.3V$ ,  $GND = PGND = CPGND = 0V$ ,  $\overline{SHDN} = V_{DD}$ , I<sup>2</sup>C settings (INA gain = +20dB, INB gain = INC gain = 0dB, volume setting = 0dB, mono path gain = 0dB,  $\overline{SHDN} = 1$ , SSM = 1). Speaker load resistors ( $R_{LSP}$ ) are terminated between  $OUT_+$  and  $OUT_-$ , headphone load resistors are terminated to GND, unless otherwise noted.  $C1 = C2 = C3 = 1\mu F$ .  $T_A = T_{MIN}$  to  $T_{MAX}$ , unless otherwise noted. Typical values are at  $T_A = +25^\circ C$ .) (Note 1)

PARAMETER	SYMBOL	CONDITIONS		MIN	TYP	MAX	UNITS
<b>RECEIVER AMPLIFIER</b>							
Output Offset Voltage	$V_{OS}$	$T_A = +25^\circ C$			±1.8	±5.5	mV
Click-and-Pop Level	$K_{CP}$	Peak voltage, $T_A = +25^\circ C$ , A-weighted, 32 samples per second (Notes 3, 6)	Into shutdown		-62		dB
			Into mute		-67		
			Out of shutdown		-63		
			Out of mute		-66		
Power-Supply Rejection Ratio (Note 3)	PSRR	$T_A = +25^\circ C$	$V_{DD} = 2.7V$ to 5.5V	58	80		dB
			f = 217Hz, 100mV <sub>P-P</sub> ripple		80		
			f = 1kHz, 100mV <sub>P-P</sub> ripple		70		
Output Power	$P_{OUT}$	$T_A = +25^\circ C$ , THD+N = 1%	$R_L = 16\Omega$		60		mW
			$R_L = 32\Omega$		50		
Gain	$A_V$				3		dB
Total Harmonic Distortion Plus Noise	THD+N	$R_L = 16\Omega$ ( $V_{OUT} = 800mV_{RMS}$ , f = 1kHz)			0.03		%
		$R_L = 32\Omega$ ( $V_{OUT} = 800mV_{RMS}$ , f = 1kHz)			0.024		
Signal-to-Noise Ratio	SNR	$R_L = 16\Omega$ , $V_{OUT} = 800mV_{RMS}$ (Note 3)	BW = 20Hz to 20kHz		87		dB
			A-weighted		89		
Slew Rate	SR				0.3		V/ $\mu s$
Capacitive Drive	$C_L$				300		pF
<b>HEADPHONE AMPLIFIERS</b>							
Output Offset Voltage	$V_{OS}$	$T_A = +25^\circ C$			±1.8	±5.5	mV
Click-and-Pop Level	$K_{CP}$	Peak voltage, $T_A = +25^\circ C$ , A-weighted, 32 samples per second (Notes 2, 4)	Into shutdown		-61		dB
			Into mute		-65		
			Out of shutdown		-60		
			Out of mute		-64		
ESD Protection		HP <sub>-</sub>	Contact		±4		kV
			Air		±8		
Power-Supply Rejection Ratio (Note 3)	PSRR	$T_A = +25^\circ C$	$V_{DD} = 2.7V$ to 5.5V	58	80		dB
			f = 217Hz, 100mV <sub>P-P</sub> ripple		80		
			f = 1kHz, 100mV <sub>P-P</sub> ripple		70		
			f = 20kHz, 100mV <sub>P-P</sub> ripple		62		

# 2 x 1.5W, Stereo Class D Audio Subsystem with DirectDrive Headphone Amplifier

MAX9775/MAX9776

## ELECTRICAL CHARACTERISTICS (continued)

( $V_{DD} = PV_{DD} = CPV_{DD} = 3.3V$ ,  $GND = PGND = CPGND = 0V$ ,  $\overline{SHDN} = V_{DD}$ , I<sup>2</sup>C settings (INA gain = +20dB, INB gain = INC gain = 0dB, volume setting = 0dB, mono path gain = 0dB,  $\overline{SHDN} = 1$ , SSM = 1). Speaker load resistors ( $R_{LSP}$ ) are terminated between  $OUT_+$  and  $OUT_-$ , headphone load resistors are terminated to GND, unless otherwise noted.  $C1 = C2 = C3 = 1\mu F$ .  $T_A = T_{MIN}$  to  $T_{MAX}$ , unless otherwise noted. Typical values are at  $T_A = +25^\circ C$ .) (Note 1)

PARAMETER	SYMBOL	CONDITIONS		MIN	TYP	MAX	UNITS
Output Power	$P_{OUT}$	$T_A = +25^\circ C$ , THD+N = 1%	$R_L = 16\Omega$		60		mW
			$R_L = 32\Omega$		50		
Current Limit					170		mA
Gain	$A_V$				+3		dB
Channel-to-Channel Gain Tracking		$T_A = +25^\circ C$			$\pm 1$		%
Total Harmonic Distortion Plus Noise	THD+N	$R_L = 16\Omega$ ( $V_{OUT} = 800mV_{RMS}$ , $f = 1kHz$ )			0.03		%
		$R_L = 32\Omega$ ( $V_{OUT} = 800mV_{RMS}$ , $f = 1kHz$ )			0.024		
Signal-to-Noise Ratio	SNR	$R_L = 16\Omega$ , $V_{OUT} = 800mV_{RMS}$	BW = 20Hz to 20kHz		92		dB
			A-weighted		93		
Slew Rate	SR				0.3		V/ $\mu s$
Capacitive Drive	$C_L$				300		pF
Crosstalk		L to R, R to L, $f = 10kHz$ , $R_L = 16\Omega$ , $V_{OUT} = 160mV_{RMS}$			75		dB
<b>VOLUME CONTROL</b>							
Volume Control		IN+6dB = 0 (minimum gain setting)	HP gain (max)		3		dB
			SP gain (max)		12		
			HP gain (min)		-72		
			SP gain (min)		-63		
		IN+6dB = 1 (maximum gain setting)	HP gain (max)		9		
			SP gain (max)		18		
			HP gain (min)		-61		
			SP gain (min)		-57		
Mono Gain		All outputs	Mono+6dB = 0		0		dB
			Mono+6dB = 1		6		
Input Pair A Control		INA+20dB = 0 (minimum gain setting)			Set by IN+6dB		dB
		INA+20dB = 1 (maximum gain setting)			20		
Mute Attenuation (Minimum Volume)		$V_{IN} = 1V_{RMS}$			80		dB
<b>DIGITAL INPUTS (<math>\overline{SHDN}</math>, SDA, SCL)</b>							
Input-Voltage High	$V_{IH}$			1.4			V
Input-Voltage Low	$V_{IL}$					0.4	V
Input Hysteresis (SDA, SCL)	$V_{HYS}$				200		mV

## 2 x 1.5W, Stereo Class D Audio Subsystem with DirectDrive Headphone Amplifier

### ELECTRICAL CHARACTERISTICS (continued)

( $V_{DD} = PV_{DD} = CPV_{DD} = 3.3V$ ,  $GND = PGND = CPGND = 0V$ ,  $\overline{SHDN} = V_{DD}$ , I<sup>2</sup>C settings (INA gain = +20dB, INB gain = INC gain = 0dB, volume setting = 0dB, mono path gain = 0dB,  $\overline{SHDN} = 1$ , SSM = 1). Speaker load resistors ( $R_{LSP}$ ) are terminated between OUT<sub>+</sub> and OUT<sub>-</sub>, headphone load resistors are terminated to GND, unless otherwise noted. C1 = C2 = C3 = 1 $\mu$ F.  $T_A = T_{MIN}$  to  $T_{MAX}$ , unless otherwise noted. Typical values are at  $T_A = +25^{\circ}C$ .) (Note 1)

PARAMETER	SYMBOL	CONDITIONS	MIN	TYP	MAX	UNITS
SDA, SCL Input Capacitance	$C_{IN}$			10		pF
Input Leakage Current	$I_{IN}$			0.3	5.0	$\mu$ A
Pulse Width of Spike Suppressed	$t_{SP}$			50		ns
<b>DIGITAL OUTPUTS (SDA Open Drain)</b>						
Output Low Voltage SDA	$V_{OL}$	$I_{SINK} = 6mA$			0.4	V
Output Fall Time SDA	$t_{OF}$	$V_{H(MIN)}$ to $V_{L(MAX)}$ bus capacitance = 10pF to 400pF, $I_{SINK} = 3mA$		250		ns
<b>I<sup>2</sup>C INTERFACE TIMING</b>						
Serial Clock Frequency	$f_{SCL}$		DC		400	kHz
Bus Free Time Between STOP and START Conditions	$t_{BUF}$		1.3			$\mu$ s
START Condition Hold	$t_{HD:STA}$		0.6			$\mu$ s
STOP Condition Setup Time	$t_{SU:STA}$		0.6			$\mu$ s
Clock Low Period	$t_{LOW}$		1.3			$\mu$ s
Clock High Period	$t_{HIGH}$		0.6			$\mu$ s
Data Setup Time	$t_{SU:DAT}$		100			ns
Data Hold Time	$t_{HD:DAT}$		0		900	ns
Maximum Receive SCL/SDA Rise Time	$t_R$				300	ns
Maximum Receive SCL/SDA Fall Time	$t_F$				300	ns
Setup Time for STOP Condition	$t_{SU:STO}$		0.6			$\mu$ s
Capacitive Load for Each Bus Line	$C_b$				400	pF

**Note 1:** All devices are 100% production tested at room temperature. All temperature limits are guaranteed by design.

**Note 2:** Measured at headphone outputs.

**Note 3:** Amplifier inputs AC-coupled to GND.

**Note 4:** Testing performed with a resistive load in series with an inductor to simulate an actual speaker load. For  $R_L = 8\Omega$ ,  $L = 68\mu H$ ; for  $R_L = 4\Omega$ ,  $L = 47\mu H$ .

**Note 5:** MAX9775 only.

**Note 6:** Testing performed at room temperature with an 8 $\Omega$  resistive load in series with a 68 $\mu H$  inductive load connected across BTL outputs for speaker amplifier. Testing performed with a 32 $\Omega$  resistive load connected between OUT<sub>-</sub> and GND for headphone amplifier. Testing performed with 32 $\Omega$  resistive load connected between OUT<sub>Rx</sub> and GND for mono receiver amplifier. Mode transitions are controlled by I<sup>2</sup>C.

# 2 x 1.5W, Stereo Class D Audio Subsystem with DirectDrive Headphone Amplifier

## Typical Operating Characteristics

( $V_{DD} = PV_{DD} = CPV_{DD} = 3.3V$ ,  $GND = PGND = CPGND = 0V$ ,  $\overline{SHDN} = V_{DD}$ , I<sup>2</sup>C default gain settings (INA gain = +20dB, INB gain = INC gain = 0dB, volume setting = 0dB, mono path gain = 0dB,  $\overline{SHDN} = 1$ , SSM = 1). Speaker load resistors ( $R_{LSP}$ ) are terminated between OUT<sub>+</sub> and OUT<sub>-</sub>, headphone load resistors are terminated to GND, unless otherwise stated.  $C_1 = C_2 = C_3 = 1\mu F$ .  $T_A = +25^\circ C$ , unless otherwise noted.)

MAX9775/MAX9776

**TOTAL HARMONIC DISTORTION PLUS NOISE vs. FREQUENCY**

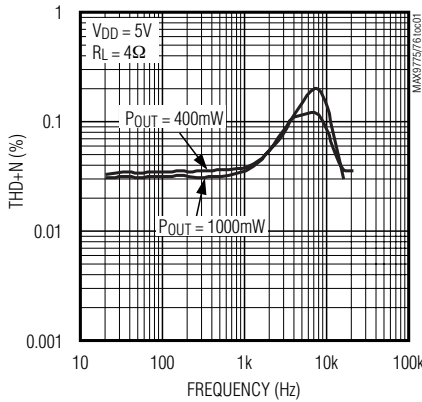

**TOTAL HARMONIC DISTORTION PLUS NOISE vs. FREQUENCY**

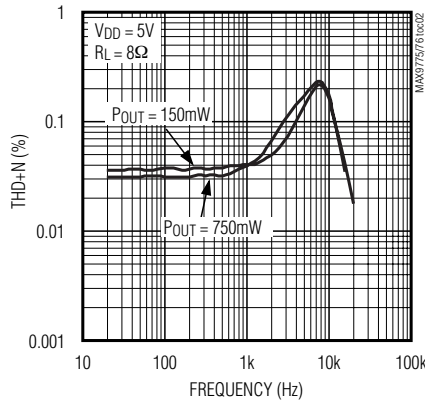

**TOTAL HARMONIC DISTORTION PLUS NOISE vs. FREQUENCY**

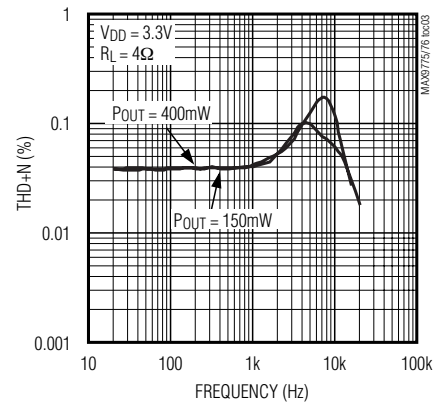

**TOTAL HARMONIC DISTORTION PLUS NOISE vs. FREQUENCY**

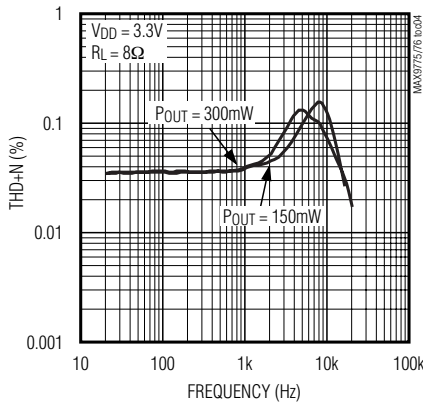

**TOTAL HARMONIC DISTORTION PLUS NOISE vs. FREQUENCY**

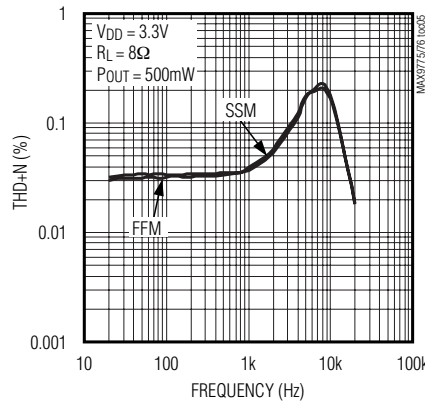

**TOTAL HARMONIC DISTORTION PLUS NOISE vs. OUTPUT POWER**

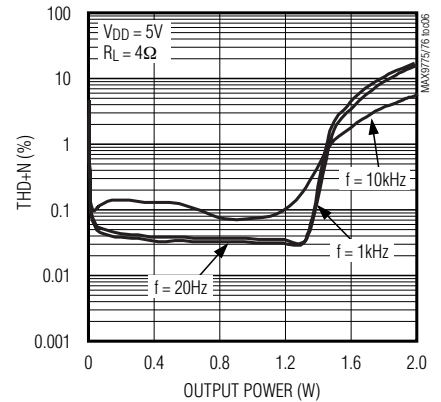

# 2 x 1.5W, Stereo Class D Audio Subsystem with DirectDrive Headphone Amplifier

## Typical Operating Characteristics (continued)

( $V_{DD} = PV_{DD} = CPV_{DD} = 3.3V$ ,  $GND = PGND = CPGND = 0V$ ,  $\overline{SHDN} = V_{DD}$ , I<sup>2</sup>C default gain settings (INA gain = +20dB, INB gain = INC gain = 0dB, volume setting = 0dB, mono path gain = 0dB,  $\overline{SHDN} = 1$ , SSM = 1). Speaker load resistors ( $R_{LSP}$ ) are terminated between OUT<sub>+</sub> and OUT<sub>-</sub>, headphone load resistors are terminated to GND, unless otherwise stated.  $C_1 = C_2 = C_3 = 1\mu F$ .  $T_A = +25^\circ C$ , unless otherwise noted.)

**TOTAL HARMONIC DISTORTION PLUS NOISE vs. OUTPUT POWER**

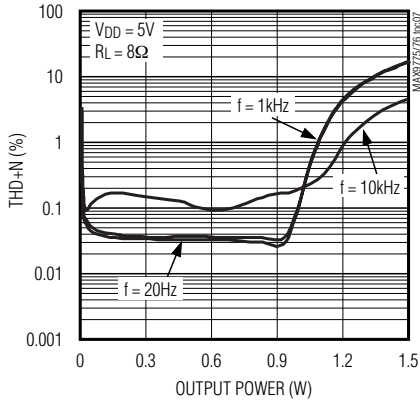

**TOTAL HARMONIC DISTORTION PLUS NOISE vs. OUTPUT POWER**

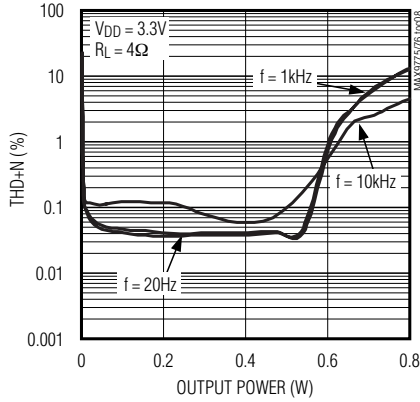

**TOTAL HARMONIC DISTORTION PLUS NOISE vs. OUTPUT POWER**

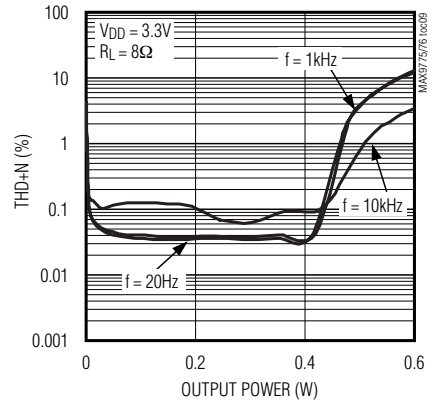

**TOTAL HARMONIC DISTORTION PLUS NOISE vs. OUTPUT POWER**

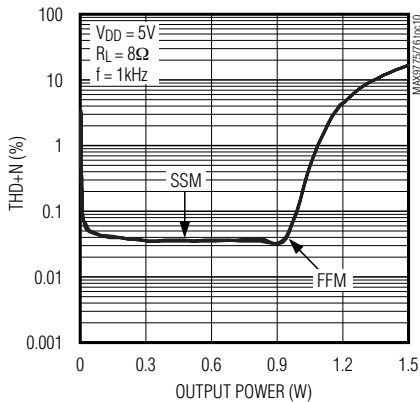

**EFFICIENCY vs. OUTPUT POWER**

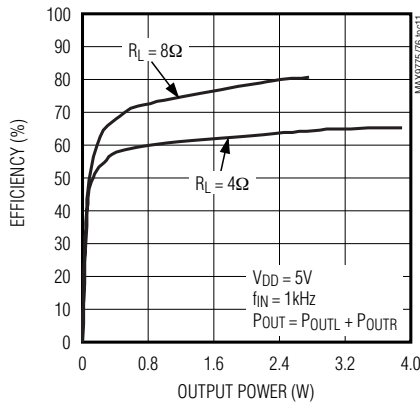

**EFFICIENCY vs. OUTPUT POWER**

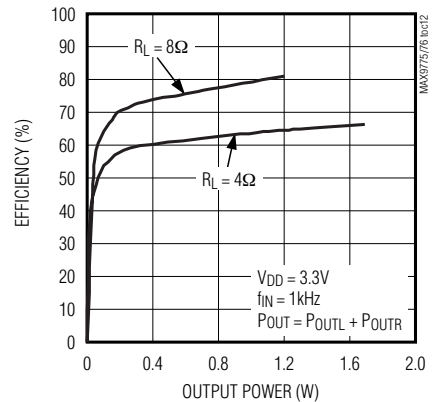



# 2 x 1.5W, Stereo Class D Audio Subsystem with DirectDrive Headphone Amplifier

## Typical Operating Characteristics (continued)

( $V_{DD} = PV_{DD} = CPV_{DD} = 3.3V$ ,  $GND = PGND = CPGND = 0V$ ,  $\overline{SHDN} = V_{DD}$ , I<sup>2</sup>C default gain settings (INA gain = +20dB, INB gain = INC gain = 0dB, volume setting = 0dB, mono path gain = 0dB,  $\overline{SHDN} = 1$ , SSM = 1). Speaker load resistors ( $R_{LSP}$ ) are terminated between OUT<sub>+</sub> and OUT<sub>-</sub>, headphone load resistors are terminated to GND, unless otherwise stated. C1 = C2 = C3 = 1 $\mu$ F. T<sub>A</sub> = +25°C, unless otherwise noted.)

MAX9775/MAX9776

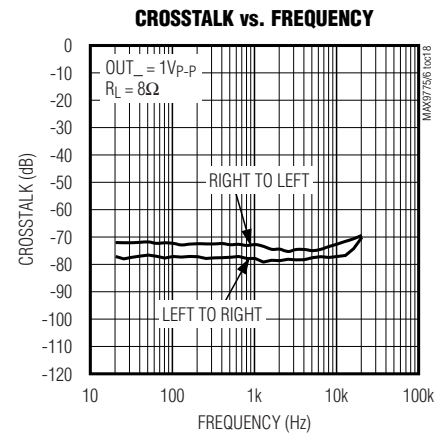
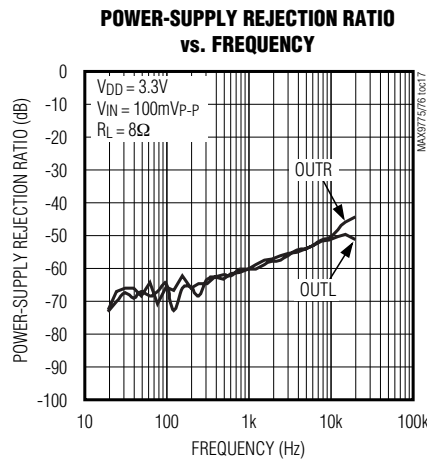
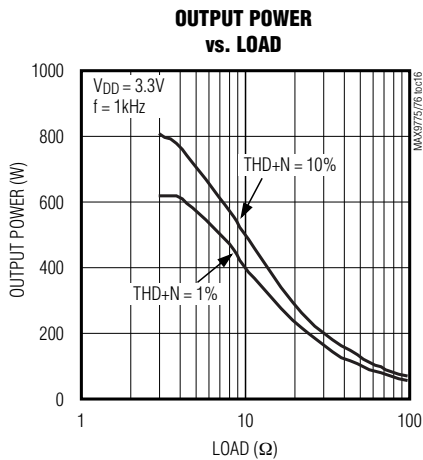
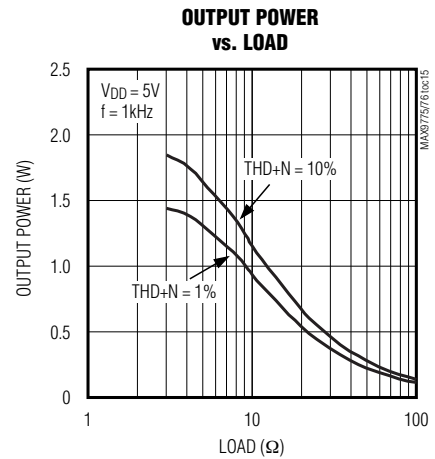
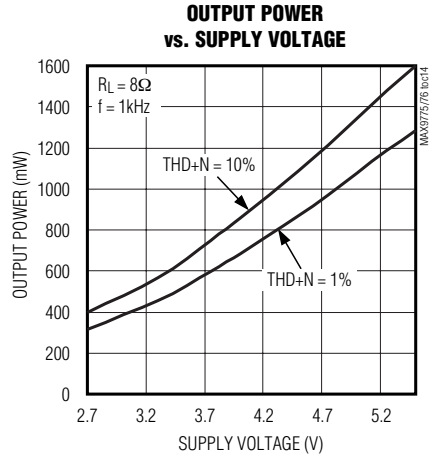
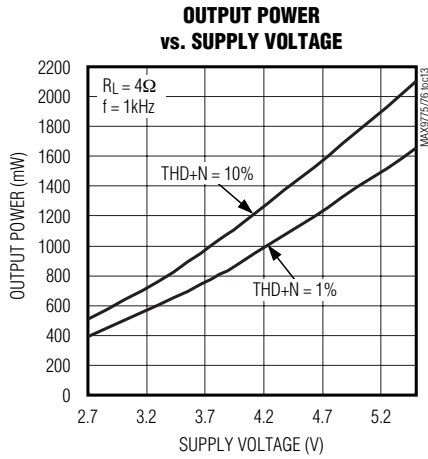

# 2 x 1.5W, Stereo Class D Audio Subsystem with DirectDrive Headphone Amplifier

## Typical Operating Characteristics (continued)

( $V_{DD} = PV_{DD} = CPV_{DD} = 3.3V$ ,  $GND = PGND = CPGND = 0V$ ,  $\overline{SHDN} = V_{DD}$ , I<sup>2</sup>C default gain settings (INA gain = +20dB, INB gain = INC gain = 0dB, volume setting = 0dB, mono path gain = 0dB,  $\overline{SHDN} = 1$ , SSM = 1). Speaker load resistors ( $R_{LSP}$ ) are terminated between OUT<sub>+</sub> and OUT<sub>-</sub>, headphone load resistors are terminated to GND, unless otherwise stated.  $C_1 = C_2 = C_3 = 1\mu F$ .  $T_A = +25^\circ C$ , unless otherwise noted.)

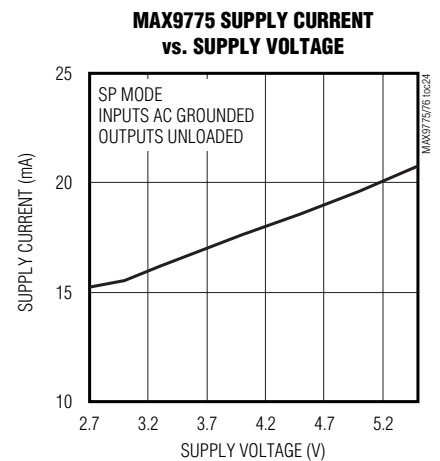
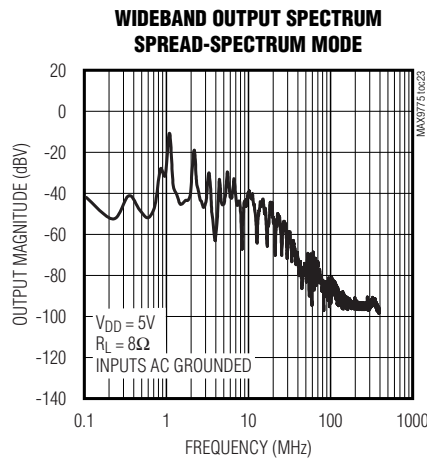
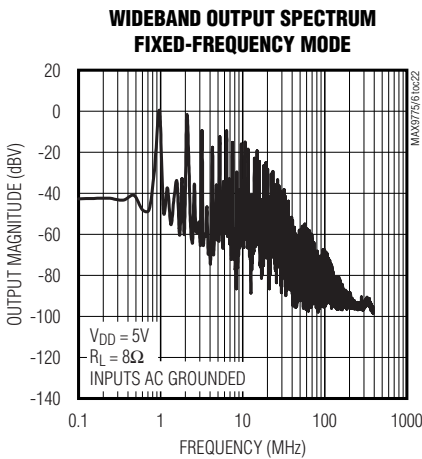
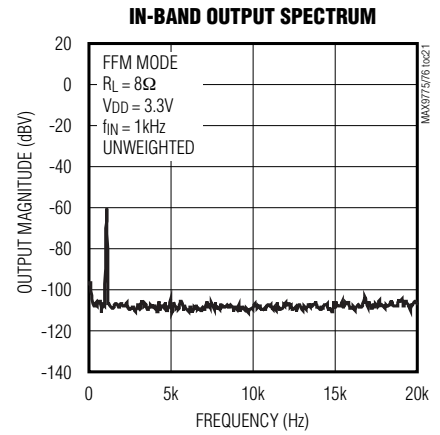
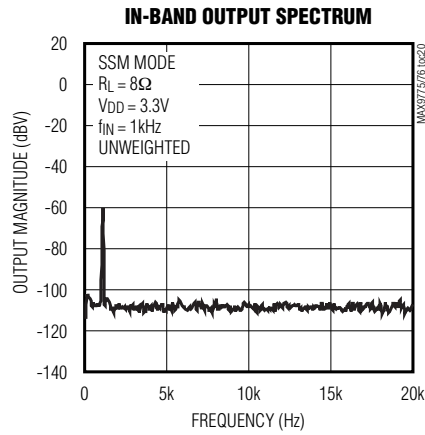
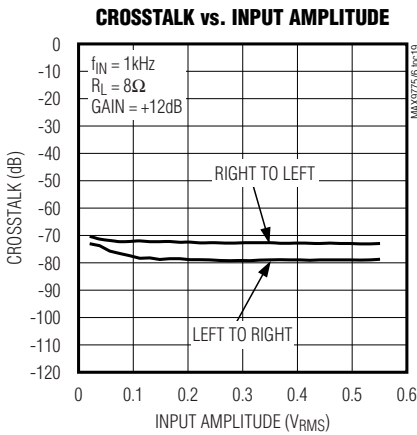

# 2 x 1.5W, Stereo Class D Audio Subsystem with DirectDrive Headphone Amplifier

MAX9775/MAX9776

## Typical Operating Characteristics (continued)

( $V_{DD} = PV_{DD} = CPV_{DD} = 3.3V$ ,  $GND = PGND = CPGND = 0V$ ,  $\overline{SHDN} = V_{DD}$ , I<sup>2</sup>C default gain settings (INA gain = +20dB, INB gain = INC gain = 0dB, volume setting = 0dB, mono path gain = 0dB,  $\overline{SHDN} = 1$ , SSM = 1). Speaker load resistors ( $R_{LSP}$ ) are terminated between OUT<sub>+</sub> and OUT<sub>-</sub>, headphone load resistors are terminated to GND, unless otherwise stated.  $C1 = C2 = C3 = 1\mu F$ .  $T_A = +25^\circ C$ , unless otherwise noted.)

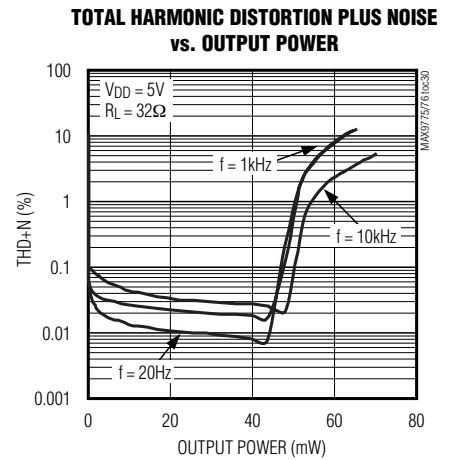
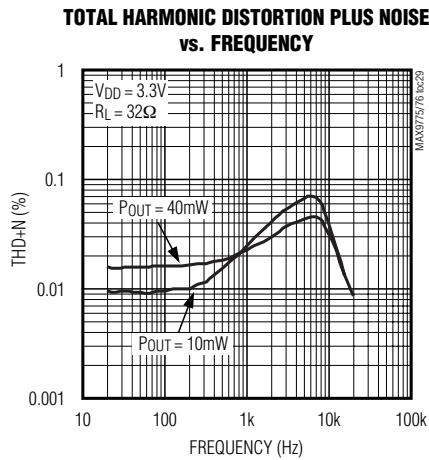
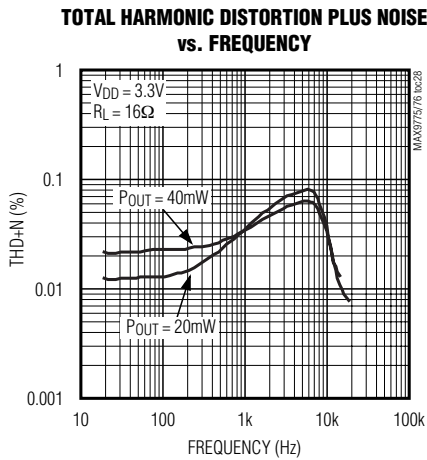
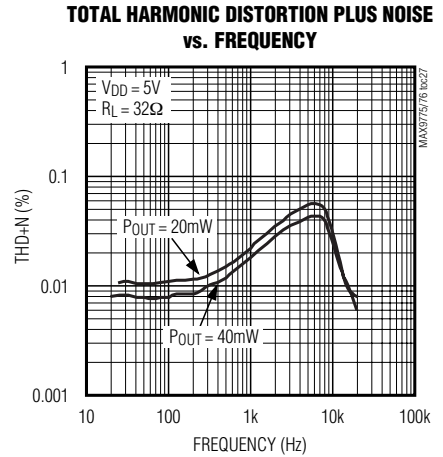
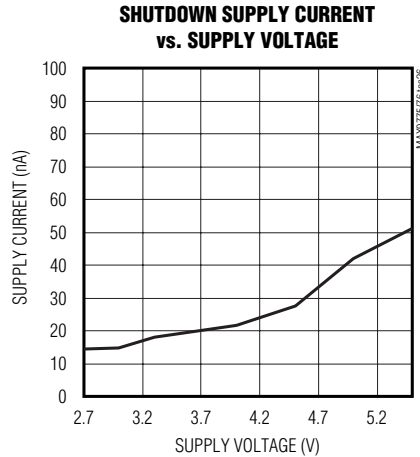
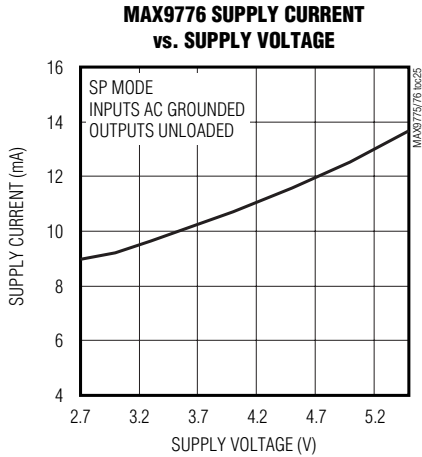

# 2 x 1.5W, Stereo Class D Audio Subsystem with DirectDrive Headphone Amplifier

## Typical Operating Characteristics (continued)

( $V_{DD} = PV_{DD} = CPV_{DD} = 3.3V$ ,  $GND = PGND = CPGND = 0V$ ,  $\overline{SHDN} = V_{DD}$ , I<sup>2</sup>C default gain settings (INA gain = +20dB, INB gain = INC gain = 0dB, volume setting = 0dB, mono path gain = 0dB,  $\overline{SHDN} = 1$ , SSM = 1). Speaker load resistors ( $R_{LSP}$ ) are terminated between OUT<sub>+</sub> and OUT<sub>-</sub>, headphone load resistors are terminated to GND, unless otherwise stated. C1 = C2 = C3 = 1 $\mu$ F. T<sub>A</sub> = +25°C, unless otherwise noted.)

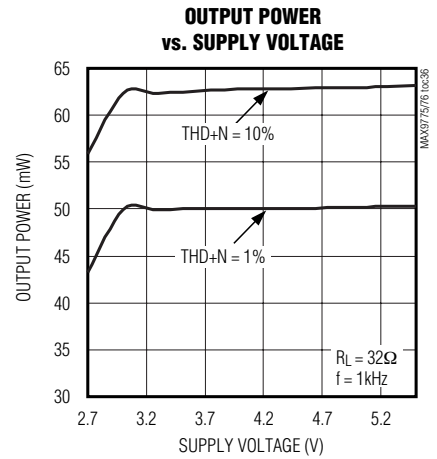
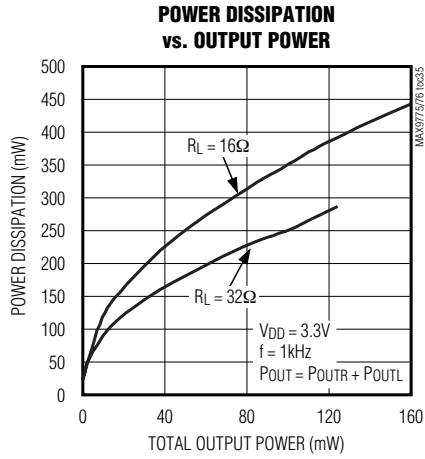
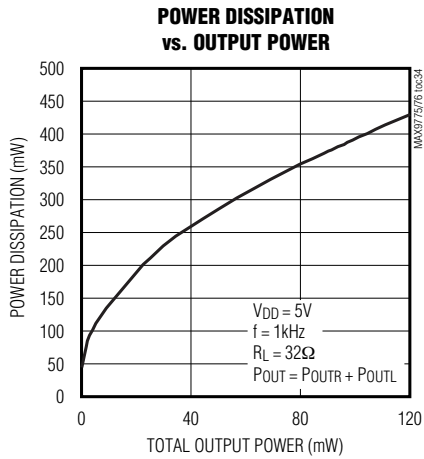
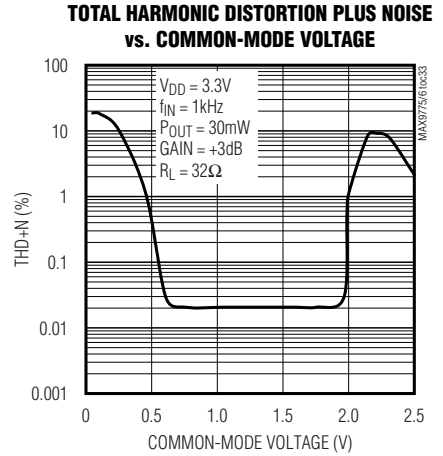
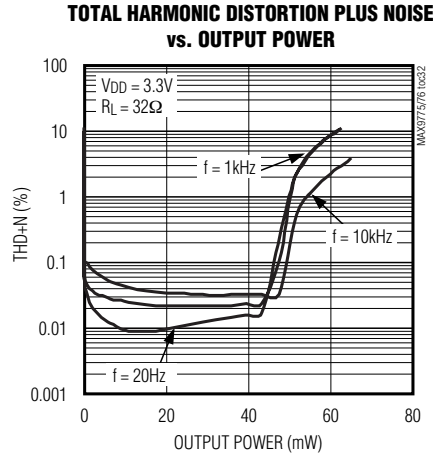
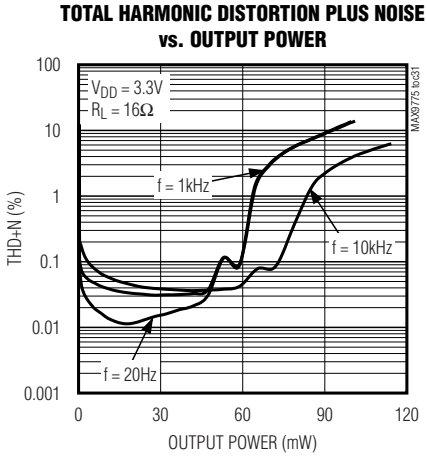

# 2 x 1.5W, Stereo Class D Audio Subsystem with DirectDrive Headphone Amplifier

## Typical Operating Characteristics (continued)

( $V_{DD} = PV_{DD} = CPV_{DD} = 3.3V$ ,  $GND = PGND = CPGND = 0V$ ,  $\overline{SHDN} = V_{DD}$ , I<sup>2</sup>C default gain settings (INA gain = +20dB, INB gain = INC gain = 0dB, volume setting = 0dB, mono path gain = 0dB,  $\overline{SHDN} = 1$ , SSM = 1). Speaker load resistors ( $R_{LSP}$ ) are terminated between OUT<sub>+</sub> and OUT<sub>-</sub>, headphone load resistors are terminated to GND, unless otherwise stated.  $C_1 = C_2 = C_3 = 1\mu F$ .  $T_A = +25^\circ C$ , unless otherwise noted.)

MAX9775/MAX9776

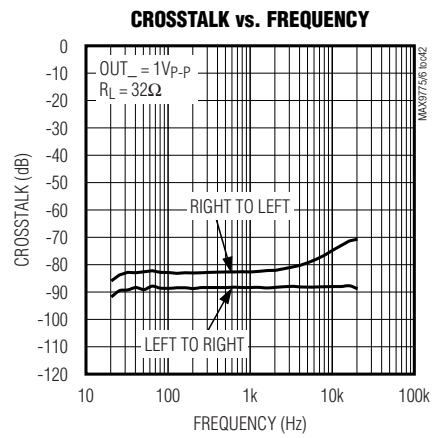
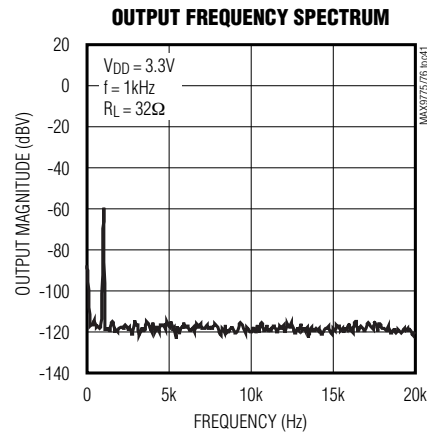
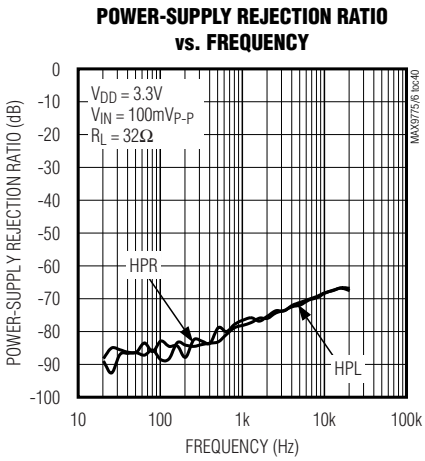
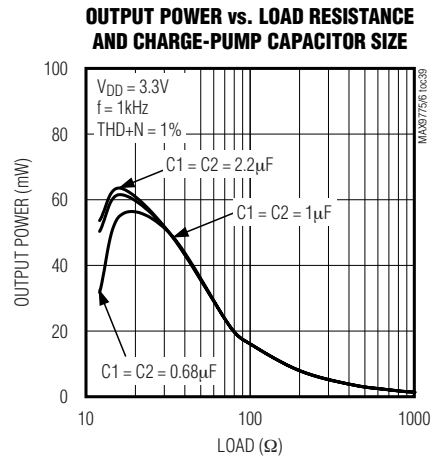
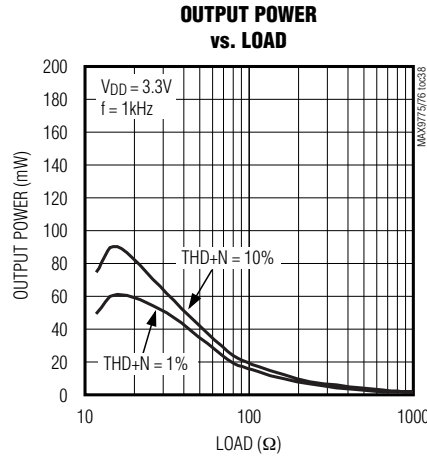
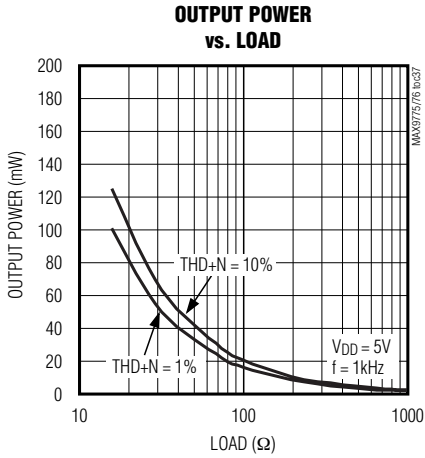

# 2 x 1.5W, Stereo Class D Audio Subsystem with DirectDrive Headphone Amplifier

## Typical Operating Characteristics (continued)

( $V_{DD} = PV_{DD} = CPV_{DD} = 3.3V$ ,  $GND = PGND = CPGND = 0V$ ,  $\overline{SHDN} = V_{DD}$ , I<sup>2</sup>C default gain settings (INA gain = +20dB, INB gain = INC gain = 0dB, volume setting = 0dB, mono path gain = 0dB,  $\overline{SHDN} = 1$ , SSM = 1). Speaker load resistors ( $R_{LSP}$ ) are terminated between OUT<sub>+</sub> and OUT<sub>-</sub>, headphone load resistors are terminated to GND, unless otherwise stated.  $C_1 = C_2 = C_3 = 1\mu F$ .  $T_A = +25^\circ C$ , unless otherwise noted.)

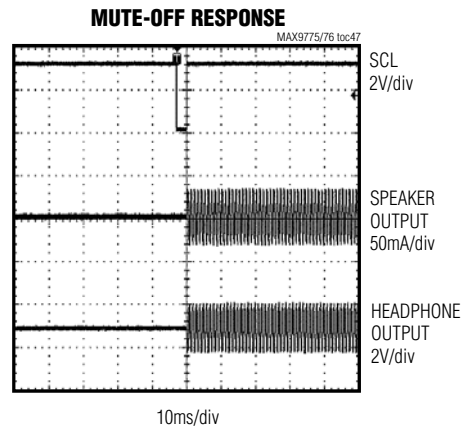
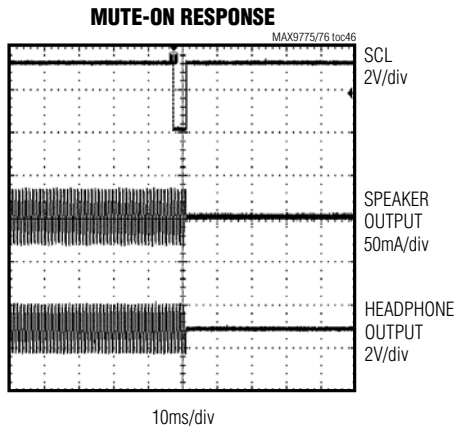
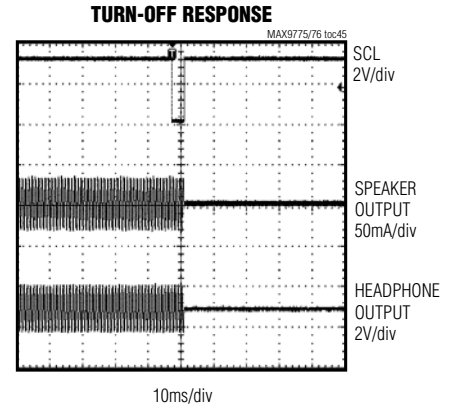
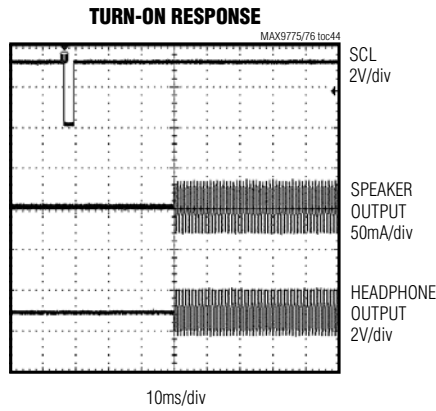
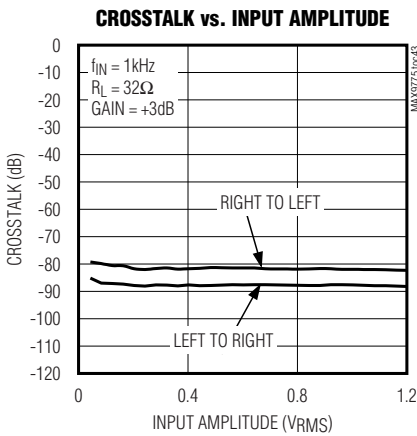

# 2 x 1.5W, Stereo Class D Audio Subsystem with DirectDrive Headphone Amplifier

## Pin Description—MAX9775

**MAX9775/MAX9776**

PIN		NAME	FUNCTION
TQFN	UCSP		
1	F1	PV <sub>DD</sub>	Class D Power Supply
2	E1	OUTL-	Negative Left-Speaker Output
3	D2	SCL	Serial Clock Input. Connect a 1k $\Omega$ pullup resistor from SCL to V <sub>DD</sub> .
4, 29	D1, F3	PGND	Power Ground
5	C1	OUTL+	Positive Left-Speaker Output
6	C2	SDA	Serial Data Input. Connect a 1k $\Omega$ pullup resistor from SDA to V <sub>DD</sub> .
7	B1	CL <sub>L</sub>	3D External Capacitor 3. Connect a 22nF capacitor to GND.
8	B2	CL <sub>H</sub>	3D External Capacitor 4. Connect a 22nF capacitor to GND.
9	A1	CPV <sub>DD</sub>	Charge-Pump Power Supply
10	A2	C1P	Charge-Pump Flying Capacitor Positive Terminal
11	B3	VBIAS	Common-Mode Bias
12	A3	CPGND	Charge-Pump GND
13	A4	C1N	Charge-Pump Flying Capacitor Negative Terminal
14	B4	INC1	Input C1. Left input or positive input (see Table 5a).
15	A5	CPV <sub>SS</sub>	Charge-Pump Output. Connect to V <sub>SS</sub> .
16	A6	HPL	Left Headphone Output
17	B5	V <sub>SS</sub>	Headphone Amplifier Negative Power Supply. Connect to CPV <sub>SS</sub> .
18	B6	HPR	Right Headphone Output
19	C5	INC2	Input C2. Right input or negative input (see Table 5a).
20	C6	OUTRx	Mono Receiver Output
21	D6	V <sub>DD</sub>	Analog Power Supply
22	D5	INB2	Input B2. Right input or negative input (see Table 5a).
23	E6	CR <sub>L</sub>	3D External Capacitor 1. Connect a 22nF capacitor to GND.
24	E5	INB1	Input B1. Left input or positive input (see Table 5a).
25	F6	GND	Analog Ground
26	F5	CR <sub>H</sub>	3D External Capacitor 2. Connect a 22nF capacitor to GND.
27	E4	INA2	Input A2. Right input or negative input (see Table 5a).
28	F4	OUTR+	Positive Right Speaker Output
30	E3	INA1	Input A1. Left input or positive input (see Table 5a).
31	F2	OUTR-	Negative Right Speaker Output
32	E2	SHDN	Active-Low Hardware Shutdown
EP	—	EP	Exposed Pad. The external pad lowers the package's thermal impedance by providing a direct heat conduction path from the die to the PCB. The exposed pad is internally connected to GND. Connect the exposed thermal pad to the GND plane.

## 2 x 1.5W, Stereo Class D Audio Subsystem with DirectDrive Headphone Amplifier

### Pin Description—MAX9776

PIN		NAME	FUNCTION
TQFN	UCSP		
1	F1	PV <sub>DD</sub>	Class D Power Supply
2	E1	OUT-	Negative Left-Speaker Output
3	D2	SCL	Serial Clock Input. Connect a 1k $\Omega$ pullup resistor from SCL to V <sub>DD</sub> .
4, 29	D1, F3	PGND	Power Ground
5	C1	OUT+	Positive Left-Speaker Output
6	C2	SDA	Serial Data Input. Connect a 1k $\Omega$ pullup resistor from SDA to V <sub>DD</sub> .
7, 8, 23, 26, 28, 31	B1, B2, E6, F2, F4, F5	I.C.	Internal Connection. Leave unconnected. This pin is internally connected to the signal path. Do not connect together or to any other pin.
9	A1	CPV <sub>DD</sub>	Charge-Pump Power Supply
10	A2	C1P	Charge-Pump Flying Capacitor Positive Terminal
11	B3	VBIAS	Common-Mode Bias
12	A3	CPGND	Charge-Pump GND
13	A4	C1N	Charge-Pump Flying Capacitor Negative Terminal
14	B4	INC1	Input C1. Left input or positive input (see Table 5a).
15	A5	CPV <sub>SS</sub>	Charge-Pump Output. Connect to V <sub>SS</sub> .
16	A6	HPL	Left Headphone Output
17	B5	V <sub>SS</sub>	Headphone Amplifier Negative Power Supply. Connect to CPV <sub>SS</sub> .
18	B6	HPR	Right Headphone Output
19	C5	INC2	Input C2. Right input or negative input (see Table 5a).
20	C6	OUTRx	Mono Receiver Output
21	D6	V <sub>DD</sub>	Analog Power Supply
22	D5	INB2	Input B2. Right input or negative input (see Table 5a).
24	E5	INB1	Input B1. Left input or positive input (see Table 5a).
25	F6	GND	Analog Ground
27	E4	INA2	Input A2. Right input or negative input (see Table 5a).
30	E3	INA1	Input A1. Left input or positive input (see Table 5a).
32	E2	SHDN	Active-Low Hardware Shutdown
EP	—	EP	Exposed Pad. The external pad lowers the package's thermal impedance by providing a direct heat conduction path from the die to the PCB. The exposed pad is internally connected to GND. Connect the exposed thermal pad to the GND plane.



# 2 x 1.5W, Stereo Class D Audio Subsystem with DirectDrive Headphone Amplifier

## Typical Application Circuits

MAX9775/MAX9776

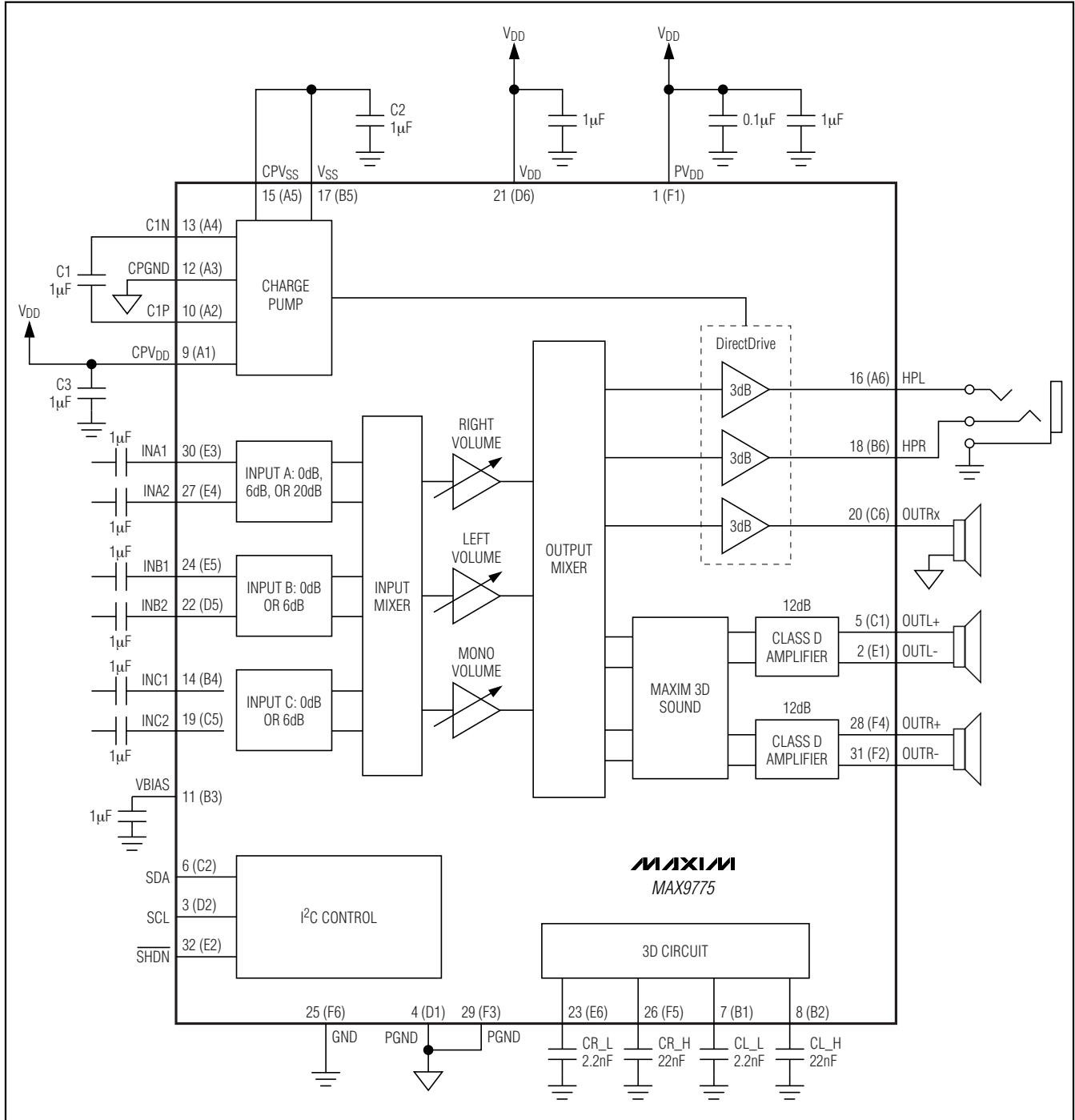

# 2 x 1.5W, Stereo Class D Audio Subsystem with DirectDrive Headphone Amplifier

## Typical Application Circuits (continued)

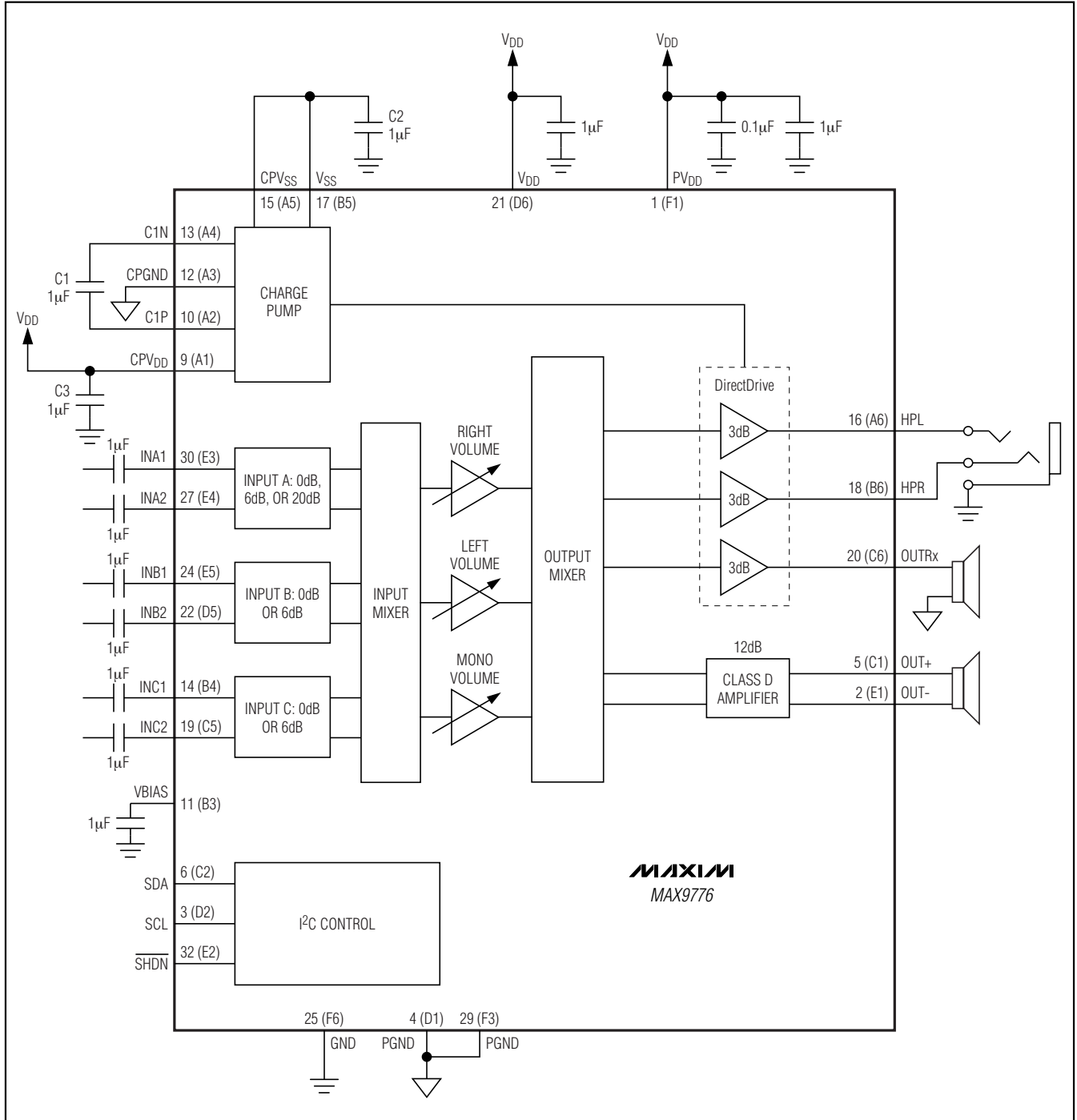

# 2 x 1.5W, Stereo Class D Audio Subsystem with DirectDrive Headphone Amplifier

## Detailed Description

The MAX9775/MAX9776 ultra-low-EMI, filterless, Class D audio power amplifiers feature several improvements to switch-mode amplifier technology. The MAX9775/MAX9776 feature active emissions limiting circuitry to reduce EMI. Zero dead-time technology maintains state-of-the-art efficiency and THD+N performance by allowing the output FETs to switch simultaneously without cross-conduction. A unique filterless modulation scheme and spread-spectrum modulation create compact, flexible, low-noise, efficient audio power amplifiers while occupying minimal board space. The differential input architecture reduces common-mode noise pickup with or without the use of input-coupling capacitors. The MAX9775/MAX9776 can also be configured as single-ended input amplifiers without performance degradation.

The MAX9775/MAX9776 feature three fully differential input pairs (INA\_, INB\_, INC\_) that can be configured as stereo single-ended or mono differential inputs. I<sup>2</sup>C provides control for input configuration, volume level, and mixer configuration. The MAX9775's 3D enhancement feature widens the stereo sound field to improve stereo imaging when stereo speakers are placed in close proximity.

DirectDrive allows the headphone and mono receiver amplifiers to output ground-referenced signals from a single supply, eliminating the need for large DC-blocking capacitors. Comprehensive click-and-pop suppression minimizes audible transients during the turn-on and turn-off of amplifiers.

## Class D Speaker Amplifier

Comparators monitor the audio inputs and compare the complementary input voltages to a sawtooth waveform. The comparators trip when the input magnitude of the sawtooth exceeds their corresponding input voltage. The active emissions limiting circuitry slightly reduces the turn-on rate of the output H-bridge by slew-rate limiting the comparator output pulse. Both comparators reset at a fixed time after the rising edge of the second comparator trip point, generating a minimum-width pulse (t<sub>ON(MIN)</sub>, 100ns typ) at the output of the second comparator (Figure 1). As the input voltage increases or decreases, the duration of the pulse at one output increases while the other output pulse duration remains the same. This causes the net voltage across the speaker (V<sub>OUT+</sub> - V<sub>OUT-</sub>) to change. The minimum-width pulse helps the devices to achieve high levels of linearity.

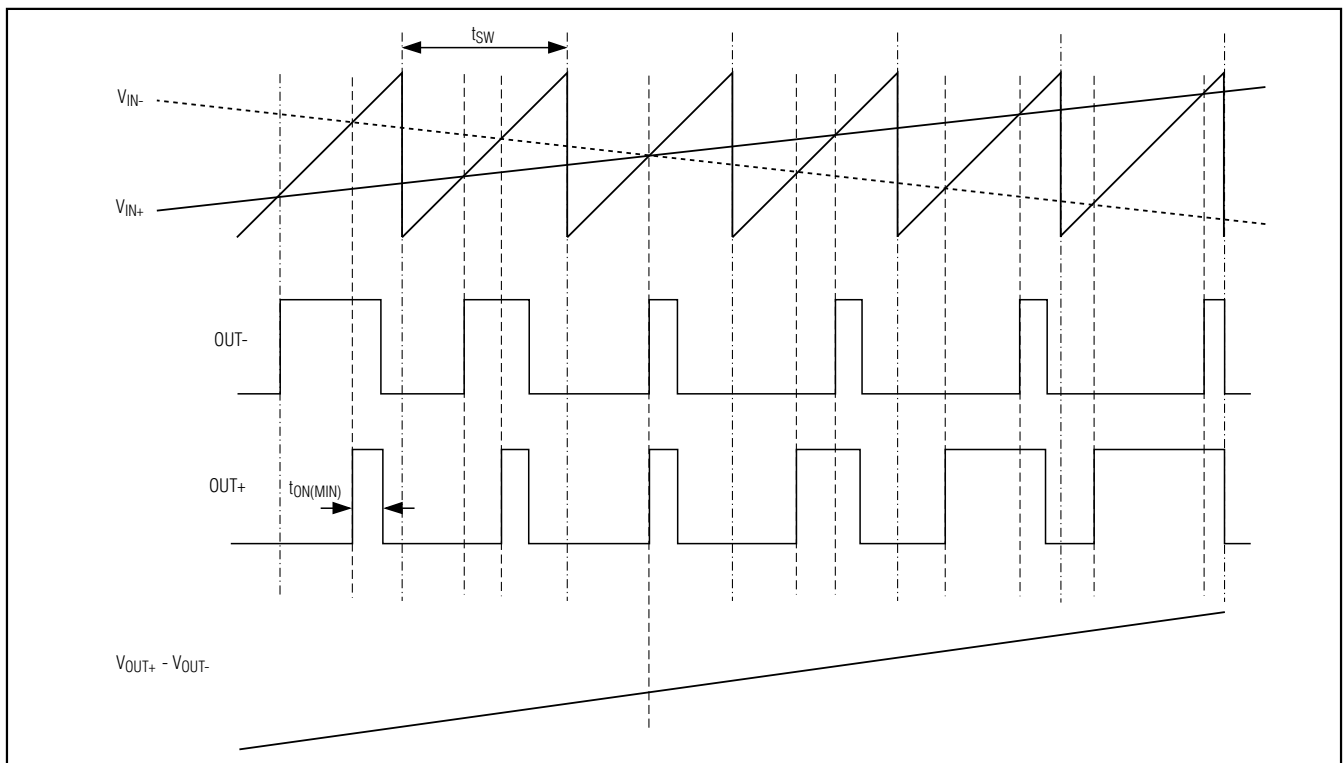

Figure 1. Outputs with an Input Signal Applied

# 2 x 1.5W, Stereo Class D Audio Subsystem with DirectDrive Headphone Amplifier

## Operating Modes

### Fixed-Frequency Modulation

The MAX9775/MAX9776 feature a fixed-frequency modulation mode with a 1.1MHz switching frequency, set through the I<sup>2</sup>C interface (Table 2). In fixed-frequency modulation mode, the frequency spectrum of the Class D output consists of the fundamental switching frequency and its associated harmonics (see the Wideband Output Spectrum Fixed-Frequency Mode graph in the *Typical Operating Characteristics*).

### Spread-Spectrum Modulation

The MAX9775/MAX9776 feature a unique, patented spread-spectrum modulation that flattens the wideband spectral components. Proprietary techniques ensure that

the cycle-to-cycle variation of the switching period does not degrade audio reproduction or efficiency (see the *Typical Operating Characteristics*). Select spread-spectrum modulation mode through the I<sup>2</sup>C interface (Table 2). In spread-spectrum modulation mode, the switching frequency varies randomly by  $\pm 30\text{kHz}$  around the center frequency (1.16MHz). The modulation scheme remains the same, but the period of the sawtooth waveform changes from cycle to cycle (Figure 2). Instead of a large amount of spectral energy present at multiples of the switching frequency, the energy is now spread over a bandwidth that increases with frequency. Above a few megahertz, the wideband spectrum looks like white noise for EMI purposes (see Figure 3).

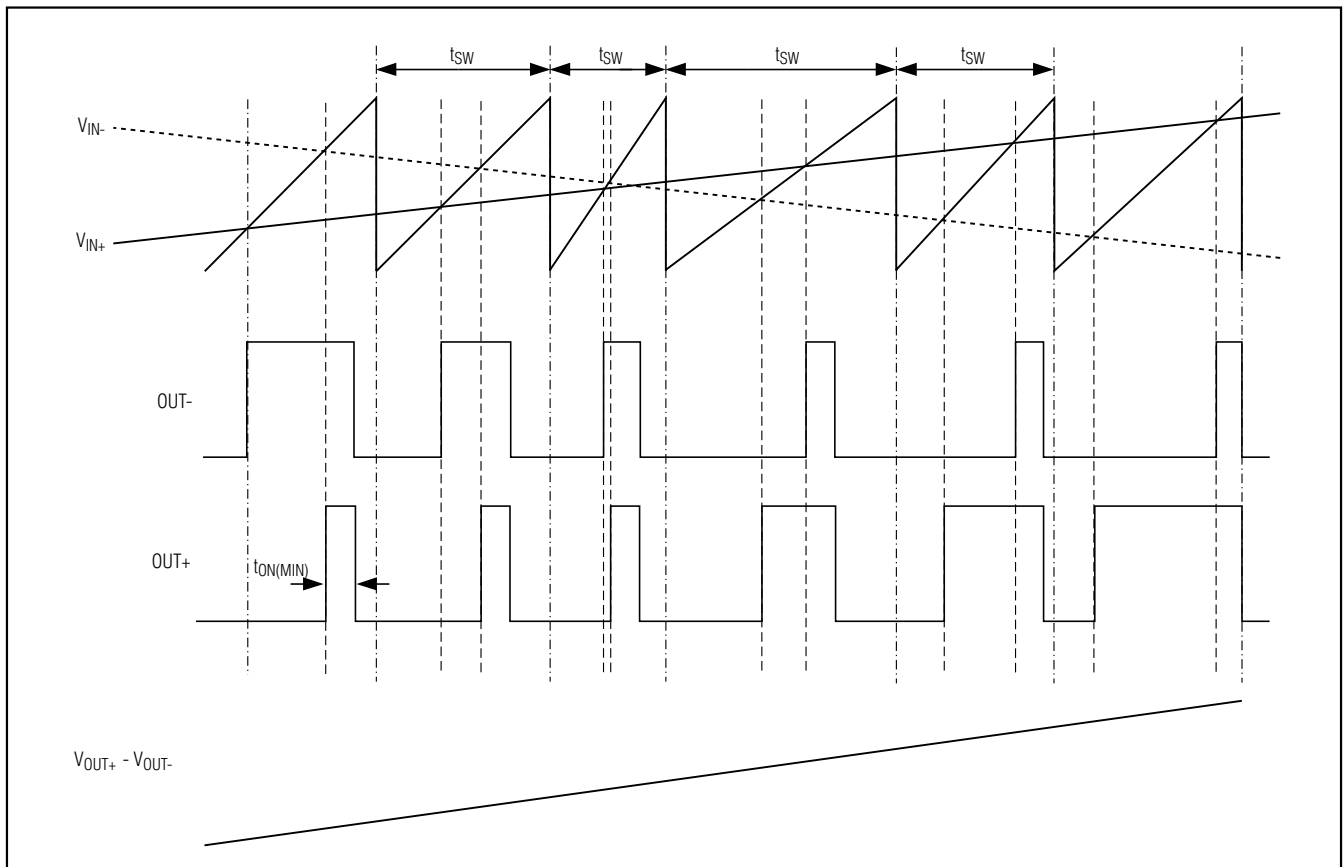

Figure 2. Output with an Input Signal Applied (Spread-Spectrum Modulation Mode)

# 2 x 1.5W, Stereo Class D Audio Subsystem with DirectDrive Headphone Amplifier

MAX9775/MAX9776

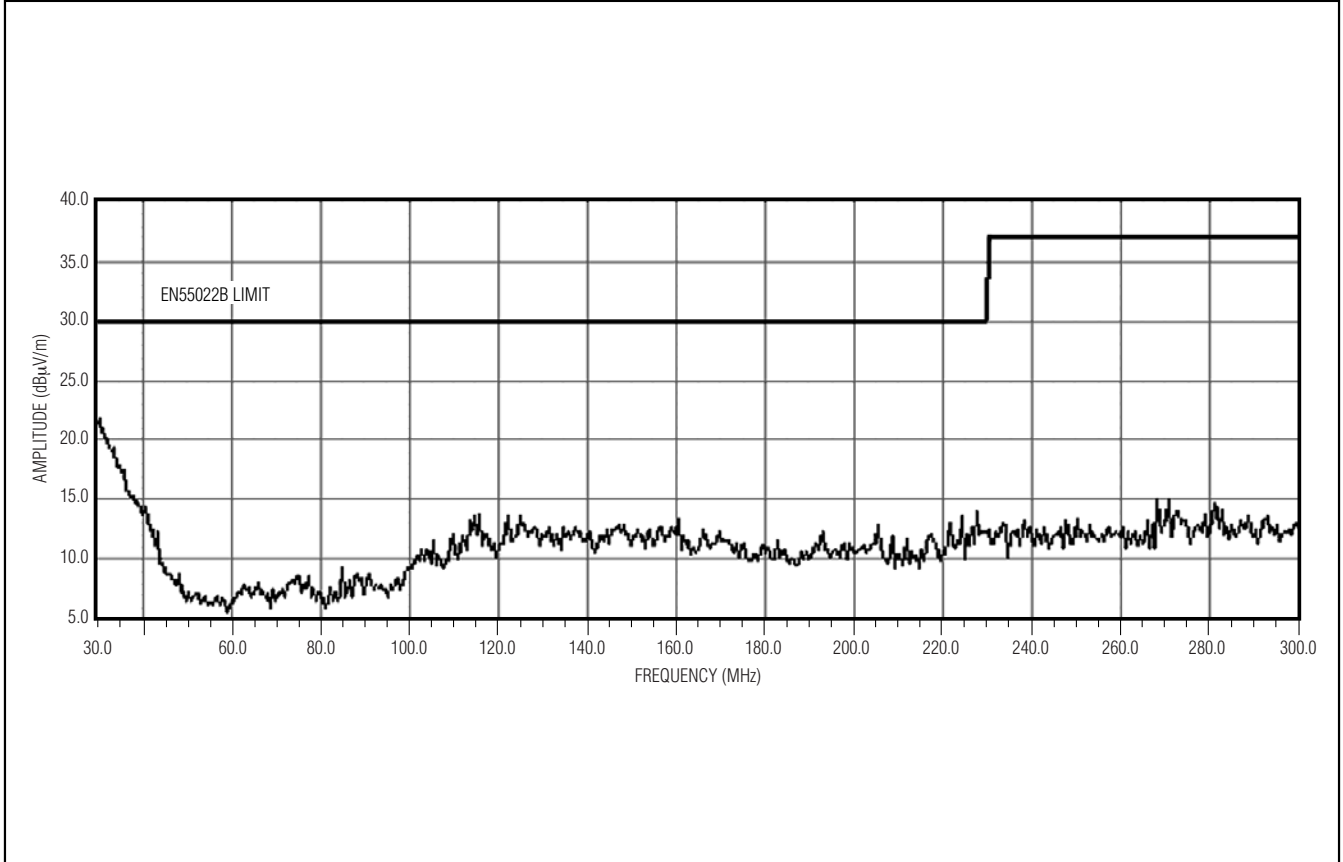

Figure 3. EMI with 76mm of Speaker Cable

## 2 x 1.5W, Stereo Class D Audio Subsystem with DirectDrive Headphone Amplifier

### Filterless Modulation/Common-Mode Idle

The MAX9775/MAX9776 use Maxim's unique, patented modulation scheme that eliminates the LC filter required by traditional Class D amplifiers, improving efficiency, reducing component count, conserving board space and system cost. Conventional Class D amplifiers output a 50% duty-cycle square wave when no signal is present. With no filter, the square wave appears across the load as a DC voltage, resulting in finite load current, increasing power consumption, especially when idling. When no signal is present at the input of the MAX9775/MAX9776, the outputs switch as shown in Figure 4. Because the MAX9775/MAX9776 drive the speaker differentially, the two outputs cancel each other, resulting in no net idle mode voltage across the speaker, minimizing power consumption.

### DirectDrive

Traditional single-supply headphone amplifiers have outputs biased at a nominal DC voltage (typically half the supply) for maximum dynamic range. Large coupling capacitors are needed to block this DC bias from the headphone. Without these capacitors, a significant amount of DC current flows to the headphone, resulting in unnecessary power dissipation and possible damage to both headphone and headphone amplifier.

Maxim's patented DirectDrive architecture uses a charge pump to create an internal negative supply voltage. This allows the headphone outputs of the MAX9775/MAX9776 to be biased at GND, almost doubling dynamic range while operating from a single supply. With no DC component, there is no need for the large DC-blocking capacitors. Instead of two large (220 $\mu$ F, typ) tantalum capacitors, the MAX9775/MAX9776 charge pump requires two small ceramic capacitors, conserving board space, reducing cost, and improving the frequency response of the headphone amplifier. See the Output Power vs. Load Resistance and Charge-Pump Capacitor Size graph in the *Typical Operating Characteristics* for details of the possible capacitor sizes. There is a low DC voltage on the amplifier outputs due to amplifier offset. However, the offset of the MAX9775/MAX9776 is typically 1.4mV, which, when combined with a 32 $\Omega$  load, results in less than 44nA of DC current flow to the headphones.

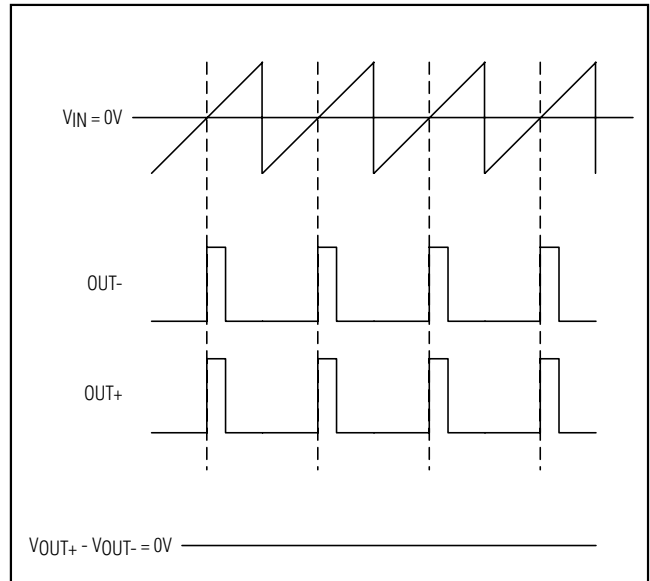

Figure 4. Outputs with No Input Signal

In addition to the cost and size disadvantages of the DC-blocking capacitors required by conventional headphone amplifiers, these capacitors limit the amplifier's low-frequency response and can distort the audio signal. Previous attempts at eliminating the output-coupling capacitors involved biasing the headphone return (sleeve) to the DC bias voltage of the headphone amplifiers. This method raises some issues:

- 1) The sleeve is typically grounded to the chassis. Using the midrail biasing approach, the sleeve must be isolated from system ground, complicating product design.
- 2) During an ESD strike, the driver's ESD structures are the only path to system ground. Thus, the amplifier must be able to withstand the full ESD strike.
- 3) When using the headphone jack as a lineout to other equipment, the bias voltage on the sleeve may conflict with the ground potential from other equipment, resulting in possible damage to the amplifiers.

# 2 x 1.5W, Stereo Class D Audio Subsystem with DirectDrive Headphone Amplifier

MAX9775/MAX9776

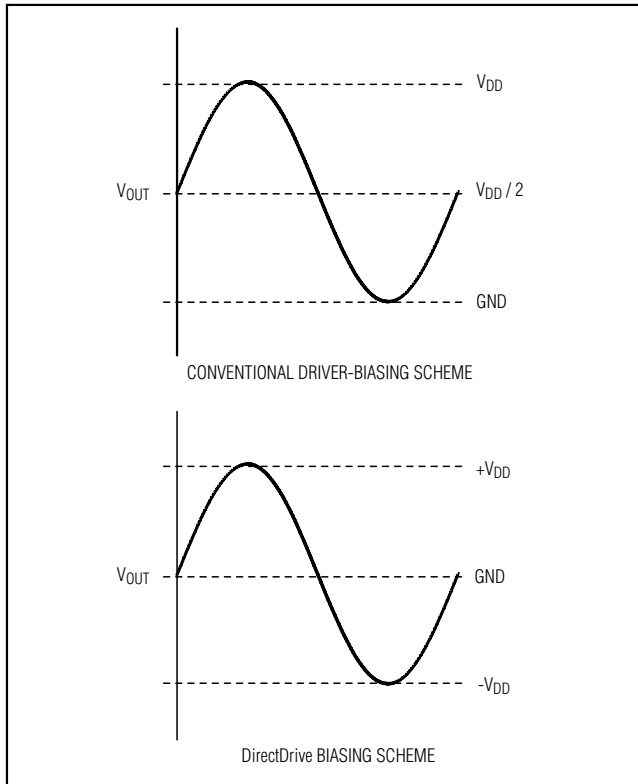

Figure 5. Traditional Amplifier Output vs. MAX9775/MAX9776 DirectDrive Output

### Charge Pump

The MAX9775/MAX9776 feature a low-noise charge pump. The switching frequency of the charge pump is half the switching frequency of the Class D amplifier, regardless of the operating mode. The nominal switching frequency is well beyond the audio range, and thus does not interfere with the audio signals, resulting in an SNR of 93dB. Although not typically required, additional high-frequency noise attenuation can be achieved by increasing the size of C2 (see the *Typical Application Circuits*). The charge pump is active in both speaker and headphone modes.

### 3D Enhancement

The MAX9775 features a 3D stereo enhancement function, allowing the MAX9775 to widen the stereo sound field and immerse the listener in a cleaner, richer sound experience. Note the MAX9776, mono Class D speaker amplifier does not feature 3D stereo enhancement.

As stereo speaker applications become more compact, the quality of stereophonic sound is jeopardized.

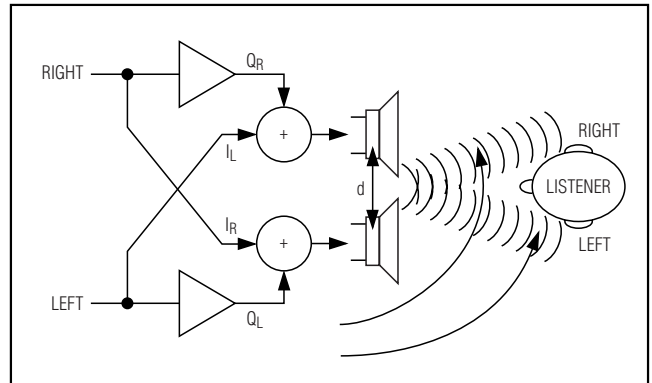

Figure 6. MAX9775 3D Stereo Enhancement

With Maxim's 3D stereo enhancement, it is possible to emulate stereo sound in situations where the speakers must be positioned close together. As shown in Figure 6, wave interference can be used to cancel the left channel in the vicinity of the listener's right ear and vice versa. This technique can yield an apparent separation between the speakers that is a factor of four or greater than the actual physical separation.

The external capacitors CL\_L, CL\_H, CR\_L, and CR\_H set the starting and stopping range of the 3D effect. CL\_H and CR\_H are for the lower limit (in the MAX9775 *Typical Application Circuit*, it is 1kHz), CR\_L and CL\_L are for the higher limit (10kHz). The internal resistor is typically 7kΩ and the frequencies are calculated as:

$$3D\_START = \frac{1}{2\pi RC}$$

where R = 7kΩ and C = CR\_H and CL\_H.

$$3D\_STOP = \frac{1}{2\pi RC}$$

where R = 7kΩ and C = CR\_L and CL\_L.

For example, with CR\_L = CL\_L = 2.2nF and CR\_H = CL\_H = 22nF, the 3D start frequency is 1kHz and the 3D stop frequency is 10kHz.

Enabling the 3D sound effect results in an apparent 6dB gain because the internal left and right signals are mixed together. This gain can be nulled by volume adjusting the left and right signals. The volume control can be programmed through the I<sup>2</sup>C-compatible interface to compensate for the extra 6dB increase in gain. For example,

## 2 x 1.5W, Stereo Class D Audio Subsystem with DirectDrive Headphone Amplifier

if the right and left volume controls are set for a maximum gain 0dB (11111 in Table 7, IN+6dB = 0 from Table 10) before the 3D effect is activated, the volume control should be programmed to -6dB (11001 in Table 7) immediately after the 3D effect has been activated.

### Signal Path

The audio inputs of the MAX9775/MAX9776—INA, INB, and INC—are preamplified and then mixed by the input mixer to create three internal signals: Left (L), Right (R), and Mono (M). Tables 5a and 5b show how the inputs are mixed to create L, R, and M. These signals are then independently volume adjusted by the L, R, and M volume control and routed to the output mixer. The output mixer mixes the internal L, R, and M signals to create a variety of audio mixes that are output to the headphone speaker and mono receiver amplifiers. Figure 6 shows the signal path that the audio signals take.

Signal amplification takes place in three stages. In the first stage, the inputs (INA, INB, and INC) are preamplified. The amount by which each input is amplified is determined by the bits INA+20dB (B4 in the Input Mode Control Register) and IN+6dB (B3 in the Global Control Register). After preamplification, they are mixed

in the Input Mixer to create the internal signals L, R, and M.

In the second stage of amplification, the internal L, R, and M signals are independently volume adjusted.

Finally, each output amplifier has its own internal gain. The speaker, headphone, and mono receiver amplifiers have fixed gains of 12dB, 3dB, and 3dB, respectively.

### Current-Limit and Thermal Protection

The MAX9775/MAX9776 feature current limiting and thermal protection to protect the device from short circuits and overcurrent conditions. The headphone amplifier pulses in the event of an overcurrent condition with a pulse every 100 $\mu$ s as long as the condition is present. Should the current still be high, the above cycle is repeated. The speaker amplifier current-limit protection clamps the output current without shutting down the output. This can result in a distorted output. Current is limited to 1.6A in the speaker amplifiers and 170mA in the headphone and mono receiver amplifiers.

The MAX9775/MAX9776 have thermal protection that disables the device at +150°C until the temperature decreases to +120°C.

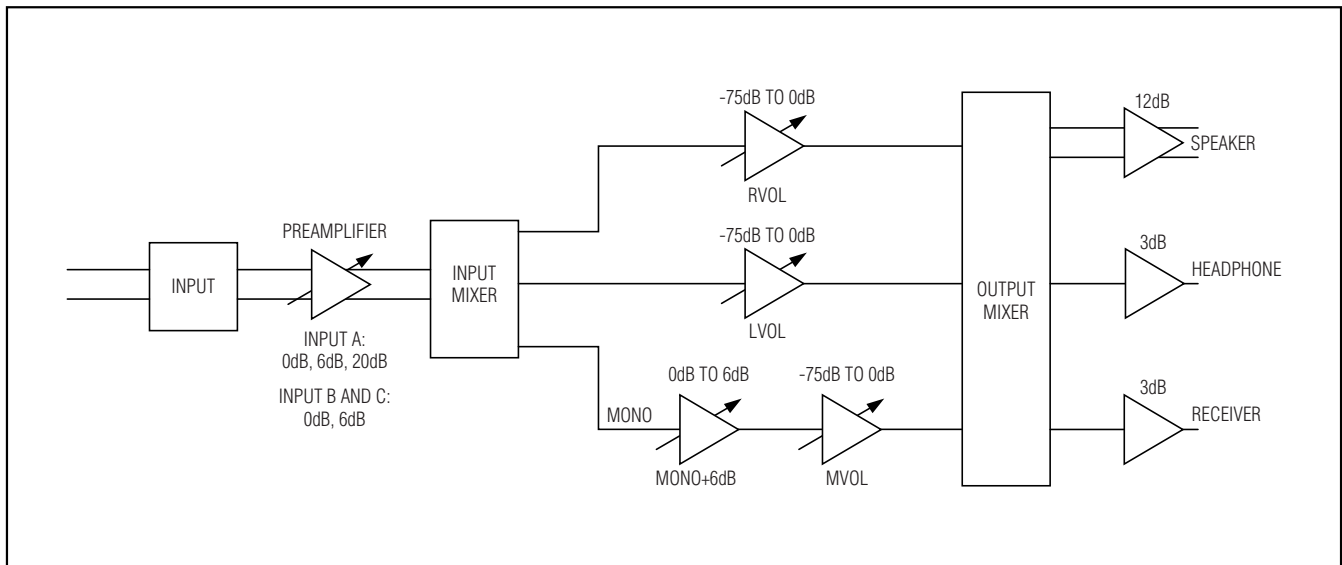

Figure 7. Signal Path



# 2 x 1.5W, Stereo Class D Audio Subsystem with DirectDrive Headphone Amplifier

## Click-and-Pop Suppression

In conventional single-supply headphone amplifiers, the output-coupling capacitor is a major contributor of audible clicks and pops. Upon startup, the amplifier charges the coupling capacitor to its bias voltage, typically half the supply. Likewise, during shutdown, the capacitor is discharged to GND. This results in a DC shift across the capacitor, which, in turn, appears as an audible transient at the speaker. Since the MAX9775/MAX9776 headphone amplifier does not require output-coupling capacitors, this problem does not arise.

In most applications, the output of the preamplifier driving the MAX9775/MAX9776 has a DC bias of typically half the supply. During startup, the input-coupling capacitor is charged to the preamplifier's DC bias voltage, resulting in a DC shift across the capacitor and an audible click/pop. An internal delay of 30ms eliminates the click/pop caused by the input filter.

## Shutdown

The MAX9775/MAX9776 feature a 0.1 $\mu$ A hard shutdown mode that reduces power consumption to extend battery life and a soft shutdown where current consumption is typically 8.5 $\mu$ A. Hard shutdown is controlled by connecting the SHDN pin to GND, disabling the amplifiers, bias circuitry, charge pump, and I<sup>2</sup>C. In shutdown, the headphone amplifier output impedance is 1.4k $\Omega$  and the speaker output impedance is 300k $\Omega$ . Similarly, the MAX9775/MAX9776 enter soft-shutdown when the SHDN bit = 0 (see Table 2). The I<sup>2</sup>C interface is active and the contents of the command register are not affected when in soft-shutdown. This allows the master to write to the MAX9775/MAX9776 while in shutdown. The I<sup>2</sup>C interface is completely disabled in hardware shutdown. When the MAX9775/MAX9776 are re-enabled the default settings are applied (see Table 3).

## I<sup>2</sup>C Interface

The MAX9775/MAX9776 feature an I<sup>2</sup>C 2-wire serial interface consisting of a serial data line (SDA) and a serial clock line (SCL). SDA and SCL facilitate communication between the MAX9775/MAX9776 and the master at clock rates up to 400kHz. Figure 8 shows the 2-wire interface timing diagram. The MAX9775/MAX9776 are receive-only slave devices relying on the master to generate the SCL signal. The master, typically a microcontroller, generates SCL and initiates data transfer on the bus. The MAX9775/MAX9776 cannot write to the SDA bus except to acknowledge the receipt of data from the master. The MAX9775/MAX9776 will not acknowledge a read command from the master.

A master device communicates to the MAX9775/MAX9776 by transmitting the proper address followed by the data word. Each transmit sequence is framed by a START (S) or REPEATED START (Sr) condition and a STOP (P) condition. Each word transmitted over the bus is 8 bits long and is always followed by an acknowledge clock pulse.

The MAX9775/MAX9776 SDA line operates as both an input and an open-drain output. A pullup resistor, greater than 500 $\Omega$ , is required on the SDA bus. The MAX9775/MAX9776 SCL line operates as an input only. A pullup resistor (greater than 500 $\Omega$ ) is required on SCL if there are multiple masters on the bus or if the master in a single-master system has an open-drain SCL output. Series resistors in line with SDA and SCL are optional. Series resistors protect the digital inputs of the MAX9775/MAX9776 from high-voltage spikes on the bus lines, and minimize crosstalk and undershoot of the bus signals.

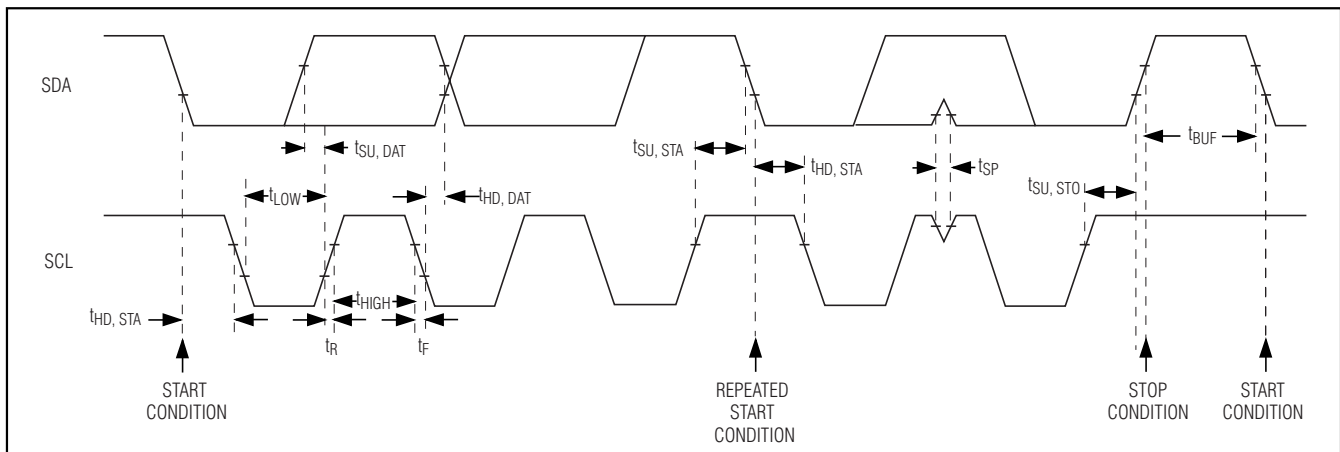

Figure 8. 2-Wire Serial-Interface Timing Diagram

# 2 x 1.5W, Stereo Class D Audio Subsystem with DirectDrive Headphone Amplifier

### Bit Transfer

One data bit is transferred during each SCL cycle. The data on SDA must remain stable during the high period of the SCL pulse. Changes in SDA while SCL is high are control signals (see the *START and STOP Conditions* section). SDA and SCL idle high when the I<sup>2</sup>C bus is not busy.

### START and STOP Conditions

A master device initiates communication by issuing a START condition. A START condition is a high-to-low transition on SDA with SCL high. A STOP condition is a low-to-high transition on SDA while SCL is high (Figure 9). A START (S) condition from the master signals the beginning of a transmission to the MAX9775/MAX9776. The master terminates transmission, and frees the bus, by issuing a STOP (P) condition. The bus remains active if a REPEATED START (Sr) condition is generated instead of a STOP condition.

### Early STOP Conditions

The MAX9775/MAX9776 recognize a STOP condition at any point during data transmission except if the STOP condition occurs in the same high pulse as a START condition.

### Slave Address

The MAX9775/MAX9776 are available with one preset slave address (see Table 1). The address is defined as

the seven most significant bits (MSBs) followed by the Read/Write bit. The address is the first byte of information sent to the MAX9775/MAX9776 after the START condition. The MAX9775/MAX9776 are slave devices only capable of being written to. The Read/Write bit should be a zero when configuring the MAX9775/MAX9776.

### Acknowledge

The acknowledge bit (ACK) is a clocked 9th bit that the MAX9775/MAX9776 use to handshake receipt of each byte of data (see Figure 10). The MAX9775/MAX9776 pull down SDA during the master-generated 9th clock pulse. Monitoring ACK allows for detection of unsuccessful data transfers. An unsuccessful data transfer occurs if a receiving device is busy or if a system fault has occurred. In the event of an unsuccessful data transfer, the bus master may reattempt communications.

**Table 1. MAX9775/MAX9776 Address Map**

PART	SLAVE ADDRESS							R/W
	A6	A5	A4	A3	A2	A1	A0	
MAX9775	1	0	0	1	1	0	0	0
MAX9776	1	0	0	1	1	0	1	0

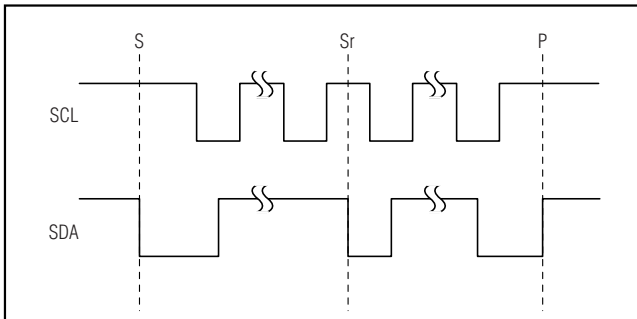

Figure 9. START, STOP, and REPEATED START Conditions

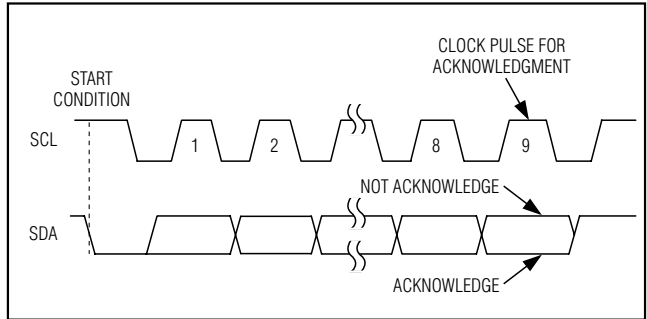

Figure 10. Acknowledge

# 2 x 1.5W, Stereo Class D Audio Subsystem with DirectDrive Headphone Amplifier

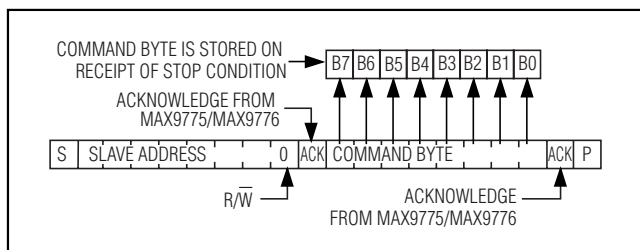

Figure 11. Write Data Format Example

### Write Data Format

A write to the MAX9775/MAX9776 includes transmission of a START condition, the slave address with the R/W bit set to 0 (Table 1), one byte of data to configure the Command Register, and a STOP condition. Figure 11 illustrates the proper format for one frame.

The MAX9775/MAX9776 only accept write data, but they acknowledge the receipt of the address byte with the R/W bit set high. The MAX9775/MAX9776 do not write to the SDA bus in the event that the R/W bit is set high. Subsequently, the master reads all 1's from the MAX9775/MAX9776. Always set the R/W bit to zero to avoid this situation.

### Programming the MAX9775/MAX9776

The MAX9775/MAX9776 are programmed through 6 control registers. Each register is addressed by the 3 MSBs (B5–B7) followed by 5 configure bits (B0–B4) as shown in Table 2. Correct programming of the MAX9775/MAX9776 requires writing to all 6 control registers. Upon power-on, their default settings are as listed in Table 3.

Table 2. Control Registers

FUNCTION	B7	B6	B5	B4	B3	B2	B1	B0
	COMMAND			DATA				
Input Mode Control	0	0	0	INA+20dB	INMODE (Tables 5a and 5b)			
Mono Volume Control	0	0	1	MVOL (Table 7)				
Left Volume Control	0	1	0	LVOL (Table 7)				
Right Volume Control	0	1	1	RVOL (Table 7)				
Output Mode Control	1	0	0	MONO+6dB	OUTMODE (Table 9)			
Global Control Register	1	0	1	SHDN	IN+6dB	MUTE	SSM	3D/MONO

Table 3. Power-On Reset Conditions

COMMAND	DATA	DESCRIPTION
Input Mode (000)	10000	Input A gain = +20dB; input A, B, and C singled-ended stereo inputs
Mono Volume (001)	11111	Maximum volume
Left Volume (010)	11111	Maximum volume
Right Volume (011)	11111	Maximum volume
Output Mode (100)	01000	0dB of extra mono gain, mode 8: stereo headphone, stereo speaker
Global Control Register (101)	00011	Powered-off, input B/C gain = 0dB, MUTE off, SSM on, 3D/MONO on

## 2 x 1.5W, Stereo Class D Audio Subsystem with DirectDrive Headphone Amplifier

### Input Mode Control

**Table 4. Input Mode Control Register**

REGISTER	B7	B6	B5	B4	B3	B2	B1	B0
Input Mode Control	0	0	0	INA+20dB	INMODE (Tables 5a and 5b)			

The MAX9775/MAX9776 have three flexible inputs that can be configured as single-ended stereo inputs or differential mono inputs. All input signals are summed into three unique signals—Left (L), Right (R), and Mono (M)—which are routed to the output amplifiers. The bit INA+20dB allows the option of boosting low-level signals on INA. INA+20dB can be set as follows:

1 = Input A's gain +20dB for low-level signals such as FM receivers.

0 = Input A's gain is either 0dB or +6dB as set by INA+6dB (bit B3 of the Control Register).

Tables 5a and 5b show how the inputs—INA, INB, and INC—are mixed to create the internal signals Left (L), Right (R), and Mono (M).

**Table 5a. Input Mode**

PROGRAMMING MODE				INPUT CONFIGURATION					
INMODE				INA1	INA2	INB1	INB2	INC1	INC2
B3	B2	B1	B0						
0	0	0	0	L	R	L	R	L	R
0	0	0	1	L	R	L	R	M+	M-
0	0	1	0	L	R	M+	M-	L	R
0	0	1	1	L	R	M+	M-	M+	M-
0	1	0	0	L	R	R+	R-	L+	L-
0	1	0	1	L	R	L+	L-	R+	R-
0	1	1	0	M+	M-	L	R	L	R
0	1	1	1	M+	M-	L	R	M+	M-
1	0	0	0	M+	M-	M+	M-	L	R
1	0	0	1	M+	M-	M+	M-	M+	M-
1	0	1	0	M+	M-	R+	R-	L+	L-
1	0	1	1	M+	M-	L+	L-	R+	R-

**Table 5b. Internal Signals L, R, and M**

PROGRAMMING MODE				INTERNAL SIGNALS LEFT (L), RIGHT (R), AND MONO (M)		
INMODE				L	R	M
B3	B2	B1	B0			
0	0	0	0	INA1 + INB1 + INC1	INA2 + INB2 + INC2	—
0	0	0	1	INA1 + INB1	INA2 + INB2	INC1 - INC2
0	0	1	0	INA1 + INC1	INA2 + INC2	INB1 - INB2
0	0	1	1	INA1	INA2	(INB1 - INB2) + (INC1 - INC2)
0	1	0	0	INA1 + (INC1 - INC2)	INA2 + (INB1 - INB2)	—
0	1	0	1	INA1 + (INB1 - INB2)	INA2 + (INC1 - INC2)	—
0	1	1	0	INB1 + INC1	INB2 + INC2	INA1 - INA2
0	1	1	1	INB1	INB2	(INA1 - INA2) + (INC1 - INC2)
1	0	0	0	INC1	INC2	(INA1 - INA2) + (INB1 - INB2)
1	0	0	1	—	—	(INA1 - INA2) + (INB1 - INB2) + (INC1 - INC2)
1	0	1	0	INC1 - INC2	INB1 - INB2	INA1 - INA2
1	0	1	1	INB1 - INB2	INC1 - INC2	INA1 - INA2

# 2 x 1.5W, Stereo Class D Audio Subsystem with DirectDrive Headphone Amplifier

Mono/Left/Right Volume Control

**Table 6. Mono/Left/Right Volume Control Registers**

REGISTER	B7	B6	B5	B4	B3	B2	B1	B0
Mono Volume Control	0	0	1	MVOL				
Left Volume Control	0	1	0	LVOL				
Right Volume Control	0	1	1	RVOL				

The MAX9775/MAX9776 have separate volume controls for each of the internal signals: Left (L), Right (R), and Mono (M). The final gain of each signal is determined by the way the following bits are set: MVOL, LVOL,

RVOL, INA+20dB, IN+6dB, and MONO+6dB. Table 7 shows how to configure the L, R, and M amplifiers for specific gains.

**Table 7. Volume Control Settings**

MVOL/LVOL/RVOL					GAIN (dB)
B4	B3	B2	B1	B0	
0	0	0	0	0	Mute
0	0	0	0	1	-75
0	0	0	1	0	-71
0	0	0	1	1	-67
0	0	1	0	0	-63
0	0	1	0	1	-59
0	0	1	1	0	-55
0	0	1	1	1	-51
0	1	0	0	0	-47
0	1	0	0	1	-44
0	1	0	1	0	-41
0	1	0	1	1	-38
0	1	1	0	0	-35
0	1	1	0	1	-32
0	1	1	1	0	-29
0	1	1	1	1	-26

MVOL/LVOL/RVOL					GAIN (dB)
B4	B3	B2	B1	B0	
1	0	0	0	0	-23
1	0	0	0	1	-21
1	0	0	1	0	-19
1	0	0	1	1	-17
1	0	1	0	0	-15
1	0	1	0	1	-13
1	0	1	1	0	-11
1	0	1	1	1	-9
1	1	0	0	0	-7
1	1	0	0	1	-6
1	1	0	1	0	-5
1	1	0	1	1	-4
1	1	1	0	0	-3
1	1	1	0	1	-2
1	1	1	1	0	-1
1	1	1	1	1	0

MAX9775/MAX9776

## 2 x 1.5W, Stereo Class D Audio Subsystem with DirectDrive Headphone Amplifier

### Output Mode Control

**Table 8. Output Mode Control Register**

REGISTER	B7	B6	B5	B4	B3	B2	B1	B0
Output Mode Control	1	0	0	MONO+6dB	OUTMODE (Table 9)			

MONO+6dB in the Output Mode Control register allows an extra 6dB of gain on the internal mono signal:

1 = Additional 6dB of gain is applied to the internal Mono (M) signal path.

0 = No additional gain is applied to the Internal Mono (M) signal path.

The MAX9775 has five output amplifiers: a mono receiver amplifier, a stereo DirectDrive headphone

amplifier, and a stereo Class D amplifier. The MAX9776 has four output amplifiers: a mono receiver amplifier, a stereo DirectDrive headphone amplifier, and a mono Class D amplifier.

Table 9 shows how each of the three internal signals—Left (L), Right (R), and Mono (M)—are mixed and routed to the various outputs.

**Table 9. Output Modes**

MODE	OUTMODE				RECEIVER	LEFT HP	RIGHT HP	MAX9775		MAX9776
	B3	B2	B1	B0				LEFT SPK	RIGHT SPK	SPK
0	0	0	0	0	—	—	—	—	—	—
1	0	0	0	1	M	—	—	—	—	—
2	0	0	1	0	—	—	—	M	M	M
3	0	0	1	1	—	M	M	M	M	M
4	0	1	0	0	—	M	M	—	—	—
5	0	1	0	1	—	—	—	—	—	—
6	0	1	1	0	L + R	—	—	—	—	—
7	0	1	1	1	—	—	—	L	R	L + R
8	1	0	0	0	—	L	R	L	R	L + R
9	1	0	0	1	—	L	R	—	—	—
10	1	0	1	0	—	—	—	—	—	—
11	1	0	1	1	M + L + R	—	—	—	—	—
12	1	1	0	0	—	—	—	L + M	R + M	L + R + M
13	1	1	0	1	—	L + M	R + M	L + M	R + M	L + R + M
14	1	1	1	0	—	L + M	R + M	—	—	—
15	1	1	1	1	MUTE	MUTE	MUTE	MUTE	MUTE	MUTE

— = Amplifier off.

L = Left signal.

R = Right signal.

M = Mono signal.

# 2 x 1.5W, Stereo Class D Audio Subsystem with DirectDrive Headphone Amplifier

Global Control Register

**Table 10. Global Control Register**

REGISTER	B7	B6	B5	B4	B3	B2	B1	B0
Global Control Register	1	0	1	SHDN	IN+6dB	MUTE	SSM	3D/MONO

The Global Control Register is used for global configurations, those affecting all inputs and outputs. The bits in the control register are shown in Table 11.

**Table 11. Global Control Register Configurations**

BIT	NAME	FUNCTION
B4	SHDN	1 = Normal operation 0 = Low-power shutdown mode. I <sup>2</sup> C settings are saved.
B3	IN+6dB	1 = All input signals are boosted by 6dB. 0 = All input signals are passed un-amplified. This bit does not affect INA if the INA+20dB bit (B4 of the Input Mode Control Register) is set to 1, in which case INA is boosted by 20dB.
B2	MUTE	1 = Mute all outputs. 0 = All outputs are active.
B1	SSM	1 = Spread-spectrum Class D modulation. 0 = Fixed-frequency Class D modulation.
B0	3D/MONO	MAX9775: 1 = 3D Enhancement is on. 0 = 3D Enhancement is off. 1 = Speakers will output L+R in modes 7, 8, 12, and 13 (see Table 9). 0 = Speakers will output L in modes 7, 8, 12, and 13 (see Table 9).

## Applications Information

### Class D Filterless Operation

Traditional Class D amplifiers require an output filter to recover the audio signal from the amplifier's PWM output. The filters add cost, increase the solution size of the amplifier, and can decrease efficiency. The traditional PWM scheme uses large differential output swings ( $2 \times V_{DD(P-P)}$ ) and causes large ripple currents. Any parasitic resistance in the filter components results in a loss of power, lowering the efficiency.

The MAX9775/MAX9776 do not require an output filter. The device relies on the inherent inductance of the speaker coil and the natural filtering of both the speaker and the human ear to recover the audio component of the square-wave output. Eliminating the output filter results in a smaller, less costly, more efficient solution.

Because the switching frequency of the MAX9775/MAX9776 speaker output is well beyond the bandwidth

of most speakers, voice coil movement due to the square-wave frequency is very small. Although this movement is small, a speaker not designed to handle the additional power may be damaged. For optimum results use a speaker with a series inductance  $> 10\mu\text{H}$ . Typical  $8\Omega$  speakers, for portable audio applications, exhibit series inductances in the  $20\mu\text{H}$  to  $100\mu\text{H}$  range.

### Input Amplifier

#### Differential Input

The MAX9775/MAX9776 feature a programmable differential input structure, making it compatible with many CODECs, and offering improved noise immunity over a single-ended input amplifier. In devices such as cell phones, high-frequency signals from the RF transmitter can be picked up by the amplifier's input traces. The signals appear at the amplifier's inputs as common-mode noise. A differential input amplifier amplifies the difference of the two inputs and any signal common to both is cancelled.

MAX9775/MAX9776

## 2 x 1.5W, Stereo Class D Audio Subsystem with DirectDrive Headphone Amplifier

### Single-Ended Input

The MAX9775/MAX9776 can be configured as a single-ended input amplifier by appropriately configuring the Input Control Register (see Tables 5a and 5b).

### DC-Coupled Input

The input amplifier can accept DC-coupled inputs that are biased to the amplifier's bias voltage. DC-coupling eliminates the input-coupling capacitors; reducing component count to potentially six external components (see the *Typical Application Circuits*). However, the highpass filtering effect of the capacitors is lost, allowing low-frequency signals to feed through to the load.

### Unused Inputs

Connect any unused input pin directly to VBIAS. This saves input capacitors on unused inputs and provides the highest noise immunity on the input.

## Component Selection

### Input Filter

An input capacitor ( $C_{IN}$ ) in conjunction with the input impedance of the MAX9775/MAX9776 form a highpass filter that removes the DC bias from the incoming signal. The AC-coupling capacitor allows the amplifiers to automatically bias the signal to an optimum DC level. Assuming zero source impedance, the -3dB point of the highpass filter is given by:

$$f_{-3dB} = \frac{1}{2\pi R_{IN} C_{IN}}$$

Choose  $C_{IN}$  so that  $f_{-3dB}$  is well below the lowest frequency of interest. Use capacitors whose dielectrics have low-voltage coefficients, such as tantalum or aluminum electrolytic. Capacitors with high-voltage coefficients, such as ceramics, may result in increased distortion at low frequencies.

Other considerations when designing the input filter include the constraints of the overall system and the actual frequency band of interest. Although high-fidelity audio calls for a flat-gain response between 20Hz and 20kHz, portable voice-reproduction devices such as cell phones and two-way radios need only concentrate on the frequency range of the spoken human voice (typi-

cally 300Hz to 3.5kHz). In addition, speakers used in portable devices typically have a poor response below 300Hz. Taking these two factors into consideration, the input filter may not need to be designed for a 20Hz to 20kHz response, saving both board space and cost due to the use of smaller capacitors.

### Class D Output Filter

The MAX9775/MAX9776 do not require a Class D output filter. The devices pass EN55022B emission standards with 152mm of unshielded speaker cables. However, output filtering can be used if a design is failing radiated emissions due to board layout or cable length, or the circuit is near EMI-sensitive devices. Use a ferrite bead filter when radiated frequencies above 10MHz are of concern. Use an LC filter when radiated frequencies below 10MHz are of concern, or when long leads (> 152mm) connect the amplifier to the speaker. Figure 12 shows optional speaker amplifier output filters.

## External Component Selection

### BIAS Capacitor

VBIAS is the output of the internally generated DC bias voltage. The VBIAS bypass capacitor,  $C_{VBIAS}$  improves PSRR and THD+N by reducing power supply and other noise sources at the common-mode bias node, and also generates the clickless/popless, startup/shutdown DC bias waveforms for the speaker amplifiers. Bypass VBIAS with a 1 $\mu$ F capacitor to GND.

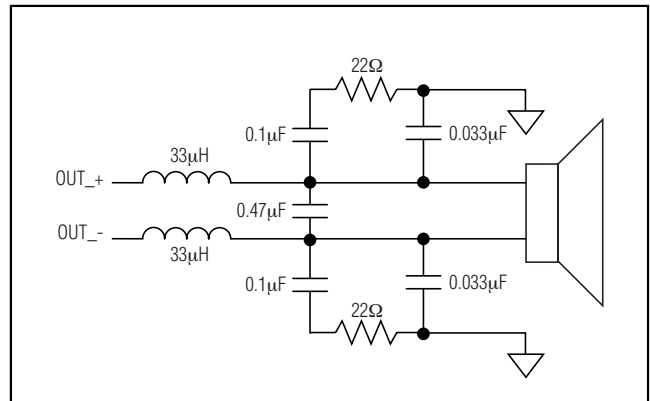

Figure 12. Speaker Amplifier Output Filter



## 2 x 1.5W, Stereo Class D Audio Subsystem with DirectDrive Headphone Amplifier

### Charge-Pump Capacitor Selection

Use capacitors with an ESR less than 100m $\Omega$  for optimum performance. Low-ESR ceramic capacitors minimize the output resistance of the charge pump. Most surface-mount ceramic capacitors satisfy the ESR requirement. For best performance over the extended temperature range, select capacitors with an X7R dielectric or better. Table 12 lists suggested manufacturers.

### Flying Capacitor (C1)

The value of the flying capacitor (C1) affects the output resistance of the charge pump. A C1 value that is too small degrades the device's ability to provide sufficient current drive, which leads to a loss of output voltage. Increasing the value of C1 reduces the charge-pump output resistance to an extent. Above 1 $\mu$ F, the on-resistance of the switches and the ESR of C1 and C2 dominate.

### Output Capacitor (C2)

The output capacitor value and ESR directly affect the ripple at CPV<sub>SS</sub>. Increasing the value of C2 reduces output ripple. Likewise, decreasing the ESR of C2 reduces both ripple and output resistance. Lower capacitance values can be used in systems with low maximum output power levels. See the Output Power vs. Load Resistance and Charge-Pump Capacitor Size graph in the *Typical Operating Characteristics*.

### CPV<sub>DD</sub> Bypass Capacitor (C3)

The CPV<sub>DD</sub> bypass capacitor (C3) lowers the output impedance of the power supply and reduces the impact of the MAX9775/MAX9776's charge-pump switching transients. Bypass CPV<sub>DD</sub> with C3 to PGND and place it physically close to the CPV<sub>DD</sub> and PGND. Use a value for C3 that is equal to C1.

### Supply Bypassing, Layout, and Grounding

Proper layout and grounding are essential for optimum performance. Use large traces for the power-supply inputs and amplifier outputs to minimize losses due to parasitic trace resistance. Large traces also aid in moving heat away from the package. Proper grounding improves audio performance, minimizes crosstalk between channels, and prevents any switching noise from coupling into the audio signal. Connect PGND and GND together at a single point on the PCB. Route all

traces that carry switching transients away from GND and the traces/components in the audio signal path.

Connect all of the power-supply inputs (CPV<sub>DD</sub>, V<sub>DD</sub>, and PV<sub>DD</sub>) together. Bypass CPV<sub>DD</sub> with a 1 $\mu$ F capacitor to CPGND. Bypass V<sub>DD</sub> with 1 $\mu$ F capacitor to GND. Bypass PV<sub>DD</sub> with a 1 $\mu$ F capacitor in parallel with a 0.1 $\mu$ F capacitor to PGND. Place the bypass capacitors as close to the MAX9775/MAX9776 as possible. Place a bulk capacitor between PV<sub>DD</sub> and PGND if needed.

Use large, low-resistance output traces. Current drawn from the outputs increases as load impedance decreases. High output trace resistance decreases the power delivered to the load. Large output, supply, and GND traces also allow more heat to move from the MAX9775/MAX9776 to the PCB, decreasing the thermal impedance of the circuit.

### TQFN Applications Information

The MAX9775/MAX9776 TQFN-EP package features an exposed thermal pad on its underside. This pad lowers the package's thermal impedance by providing a direct heat conduction path from the die to the PCB. The exposed pad is internally connected to GND. Connect the exposed thermal pad to the PCB GND plane.

### UCSP Applications Information

For the latest application details on UCSP construction, dimensions, tape carrier information, PCB techniques, bump-pad layout, and recommended reflow temperature profile, as well as the latest information of reliability testing results, refer to Application Note: *UCSP—A Wafer-Level Chip-Scale Package* available on Maxim's website at [www.maxim-ic.com/ucsp](http://www.maxim-ic.com/ucsp).

### UCSP Thermal Consideration

When operating at maximum output power, the UCSP thermal dissipation can become a limiting factor. The UCSP package does not dissipate as much power as a TQFN and as a result will operate at a higher temperature. At peak output power into a 4 $\Omega$  load, the MAX9775/MAX9776 can exceed its thermal limit, triggering thermal protection. As a result, do not choose the UCSP package when maximum output power into 4 $\Omega$  is required.

**Table 12. Suggested Capacitor Manufacturers**

SUPPLIER	PHONE	FAX	WEBSITE
Taiyo Yuden	800-348-2496	847-925-0899	<a href="http://www.t-yuden.com">www.t-yuden.com</a>
TDK	807-803-6100	847-390-4405	<a href="http://www.component.tdk.com">www.component.tdk.com</a>

# 2 x 1.5W, Stereo Class D Audio Subsystem with DirectDrive Headphone Amplifier

## Pin Configurations

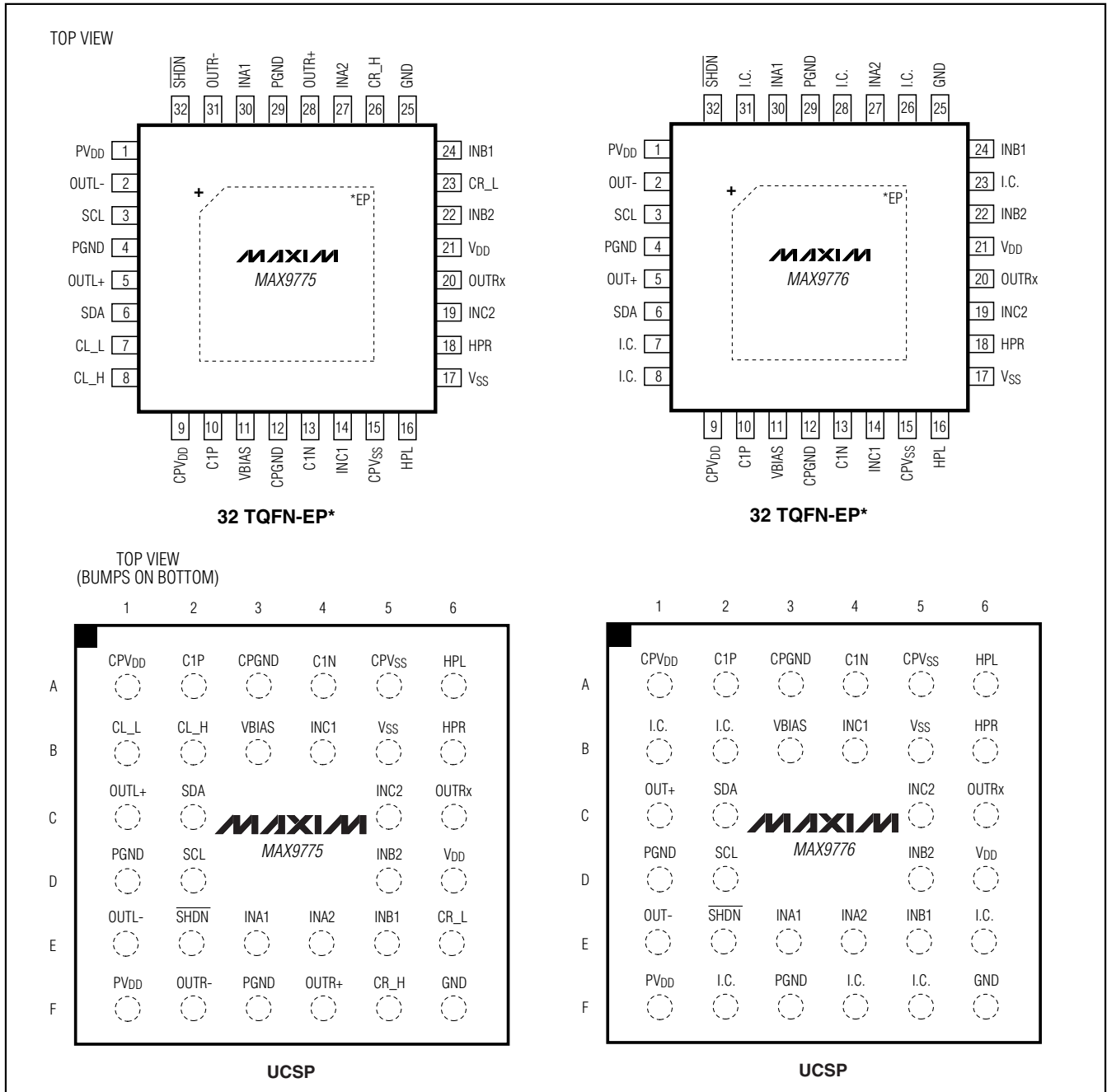

### Chip Information

PROCESS: BiCMOS

# 2 x 1.5W, Stereo Class D Audio Subsystem with DirectDrive Headphone Amplifier

## Package Information

(The package drawing(s) in this data sheet may not reflect the most current specifications. For the latest package outline information go to [www.maxim-ic.com/packages](http://www.maxim-ic.com/packages).)

MAX9775/MAX9776

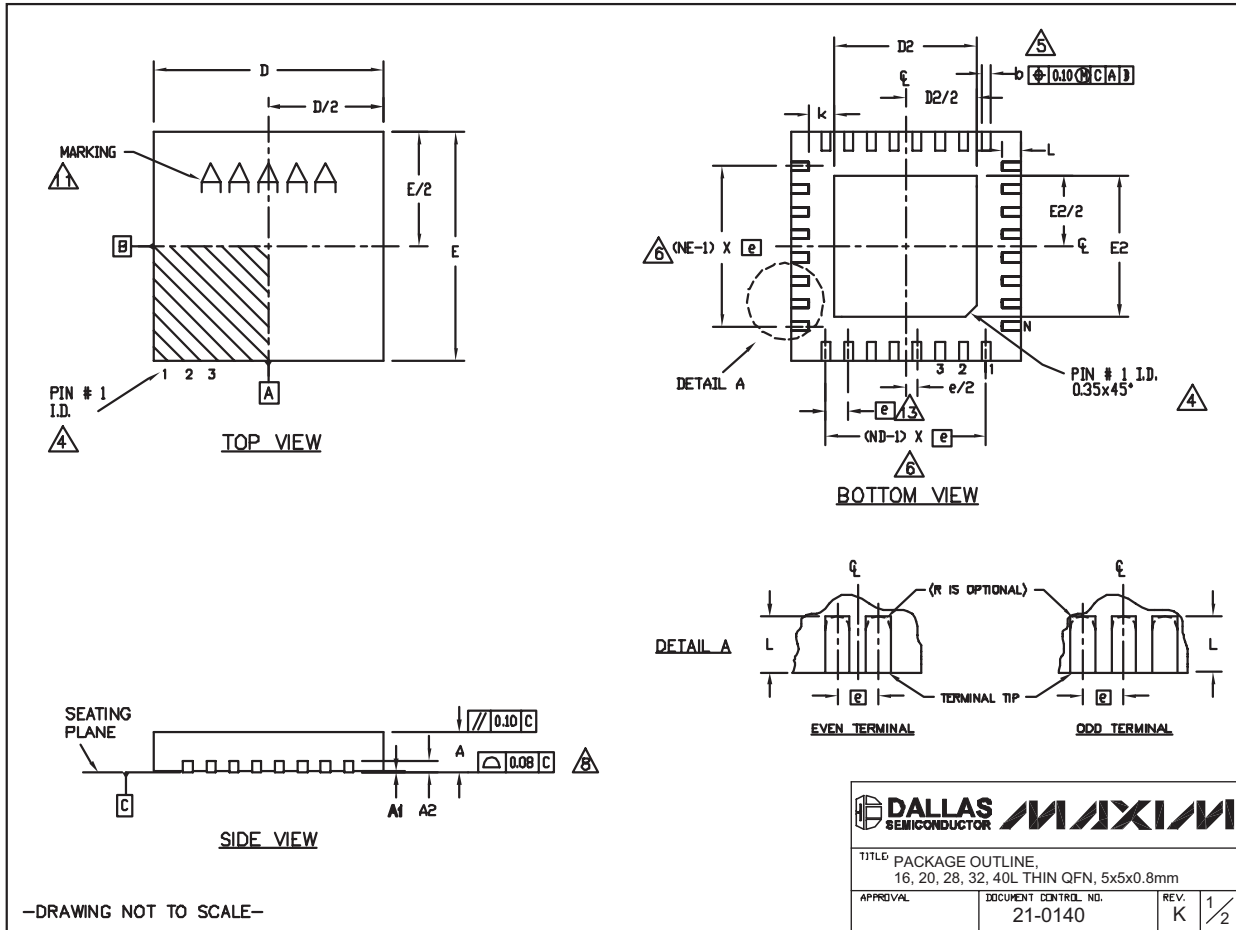

-DRAWING NOT TO SCALE-

TITLE: PACKAGE OUTLINE, 16, 20, 28, 32, 40L THIN QFN, 5x5x0.8mm	
APPROVAL	DOCUMENT CONTROL NO. 21-0140
REV. K	1/2

# 2 x 1.5W, Stereo Class D Audio Subsystem with DirectDrive Headphone Amplifier

## Package Information (continued)

(The package drawing(s) in this data sheet may not reflect the most current specifications. For the latest package outline information go to [www.maxim-ic.com/packages](http://www.maxim-ic.com/packages).)

COMMON DIMENSIONS															
PKG. SYMBOL	16L 5x5			20L 5x5			28L 5x5			32L 5x5			40L 5x5		
	MIN.	NOM.	MAX.	MIN.	NOM.	MAX.	MIN.	NOM.	MAX.	MIN.	NOM.	MAX.	MIN.	NOM.	MAX.
A	0.70	0.75	0.80	0.70	0.75	0.80	0.70	0.75	0.80	0.70	0.75	0.80	0.70	0.75	0.80
A1	0	0.02	0.05	0	0.02	0.05	0	0.02	0.05	0	0.02	0.05	0	0.02	0.05
A2	0.20 REF.			0.20 REF.			0.20 REF.			0.20 REF.			0.20 REF.		
b	0.25	0.30	0.35	0.25	0.30	0.35	0.20	0.25	0.30	0.20	0.25	0.30	0.15	0.20	0.25
D	4.90	5.00	5.10	4.90	5.00	5.10	4.90	5.00	5.10	4.90	5.00	5.10	4.90	5.00	5.10
E	4.90	5.00	5.10	4.90	5.00	5.10	4.90	5.00	5.10	4.90	5.00	5.10	4.90	5.00	5.10
e	0.80 BSC.			0.65 BSC.			0.50 BSC.			0.50 BSC.			0.40 BSC.		
k	0.25	-	-	0.25	-	-	0.25	-	-	0.25	-	-	0.25	-	-
L	0.30	0.40	0.50	0.45	0.55	0.65	0.45	0.55	0.65	0.30	0.40	0.50	0.30	0.40	0.50
N	16			20			28			32			40		
ND	4			5			7			8			10		
NE	4			5			7			8			10		
JEDEC	VHHB			WHHC			WHHD-1			WHHD-2			-----		

EXPOSED PAD VARIATIONS							
PKG. CODES	D2			E2			
	MIN.	NOM.	MAX.	MIN.	NOM.	MAX.	
T1655-2	3.00	3.10	3.20	3.00	3.10	3.20	
T1655-3	3.00	3.10	3.20	3.00	3.10	3.20	
T1655N-1	3.00	3.10	3.20	3.00	3.10	3.20	
T2055-3	3.00	3.10	3.20	3.00	3.10	3.20	
T2055-4	3.00	3.10	3.20	3.00	3.10	3.20	
T2055-5	3.15	3.25	3.35	3.15	3.25	3.35	
T2055M-5	3.15	3.25	3.35	3.15	3.25	3.35	
T2855-3	3.15	3.25	3.35	3.15	3.25	3.35	
T2855-4	2.60	2.70	2.80	2.60	2.70	2.80	
T2855-5	2.60	2.70	2.80	2.60	2.70	2.80	
T2855-6	3.15	3.25	3.35	3.15	3.25	3.35	
T2855-7	2.60	2.70	2.80	2.60	2.70	2.80	
T2855-8	3.15	3.25	3.35	3.15	3.25	3.35	
T2855N-1	3.15	3.25	3.35	3.15	3.25	3.35	
T3255-3	3.00	3.10	3.20	3.00	3.10	3.20	
T3255-4	3.00	3.10	3.20	3.00	3.10	3.20	
T3255M-4	3.00	3.10	3.20	3.00	3.10	3.20	
T3255-5	3.00	3.10	3.20	3.00	3.10	3.20	
T3255N-1	3.00	3.10	3.20	3.00	3.10	3.20	
T4055-1	3.40	3.50	3.60	3.40	3.50	3.60	
T4055-2	3.40	3.50	3.60	3.40	3.50	3.60	

**NOTES:**

- DIMENSIONING & TOLERANCING CONFORM TO ASME Y14.5M-1994.
- ALL DIMENSIONS ARE IN MILLIMETERS. ANGLES ARE IN DEGREES.
- N IS THE TOTAL NUMBER OF TERMINALS.
- THE TERMINAL #1 IDENTIFIER AND TERMINAL NUMBERING CONVENTION SHALL CONFORM TO JEDEC 95-1 SPP-012. DETAILS OF TERMINAL #1 IDENTIFIER ARE OPTIONAL, BUT MUST BE LOCATED WITHIN THE ZONE INDICATED. THE TERMINAL #1 IDENTIFIER MAY BE EITHER A MOLD OR MARKED FEATURE.
- DIMENSION b APPLIES TO METALLIZED TERMINAL AND IS MEASURED BETWEEN 0.25 mm AND 0.30 mm FROM TERMINAL TIP.
- ND AND NE REFER TO THE NUMBER OF TERMINALS ON EACH D AND E SIDE RESPECTIVELY.
- DEPOPULATION IS POSSIBLE IN A SYMMETRICAL FASHION.
- COPLANARITY APPLIES TO THE EXPOSED HEAT SINK SLUG AS WELL AS THE TERMINALS.
- DRAWING CONFORMS TO JEDEC M0220, EXCEPT EXPOSED PAD DIMENSION FOR T2855-3, T2855-6, T4055-1 AND T4055-2.
- WARPAGE SHALL NOT EXCEED 0.10 mm.
- MARKING IS FOR PACKAGE ORIENTATION REFERENCE ONLY.
- NUMBER OF LEADS SHOWN ARE FOR REFERENCE ONLY.
- LEAD CENTERLINES TO BE AT TRUE POSITION AS DEFINED BY BASIC DIMENSION 'e', ±0.05.

—DRAWING NOT TO SCALE—

TITLE: PACKAGE OUTLINE, 16, 20, 28, 32, 40L THIN QFN, 5x5x0.8mm			
APPROVAL	DOCUMENT CONTROL NO.	REV.	2/2
	21-0140	K	

# 2 x 1.5W, Stereo Class D Audio Subsystem with DirectDrive Headphone Amplifier

## Package Information (continued)

(The package drawing(s) in this data sheet may not reflect the most current specifications. For the latest package outline information go to [www.maxim-ic.com/packages](http://www.maxim-ic.com/packages).)

MAX9775/MAX9776

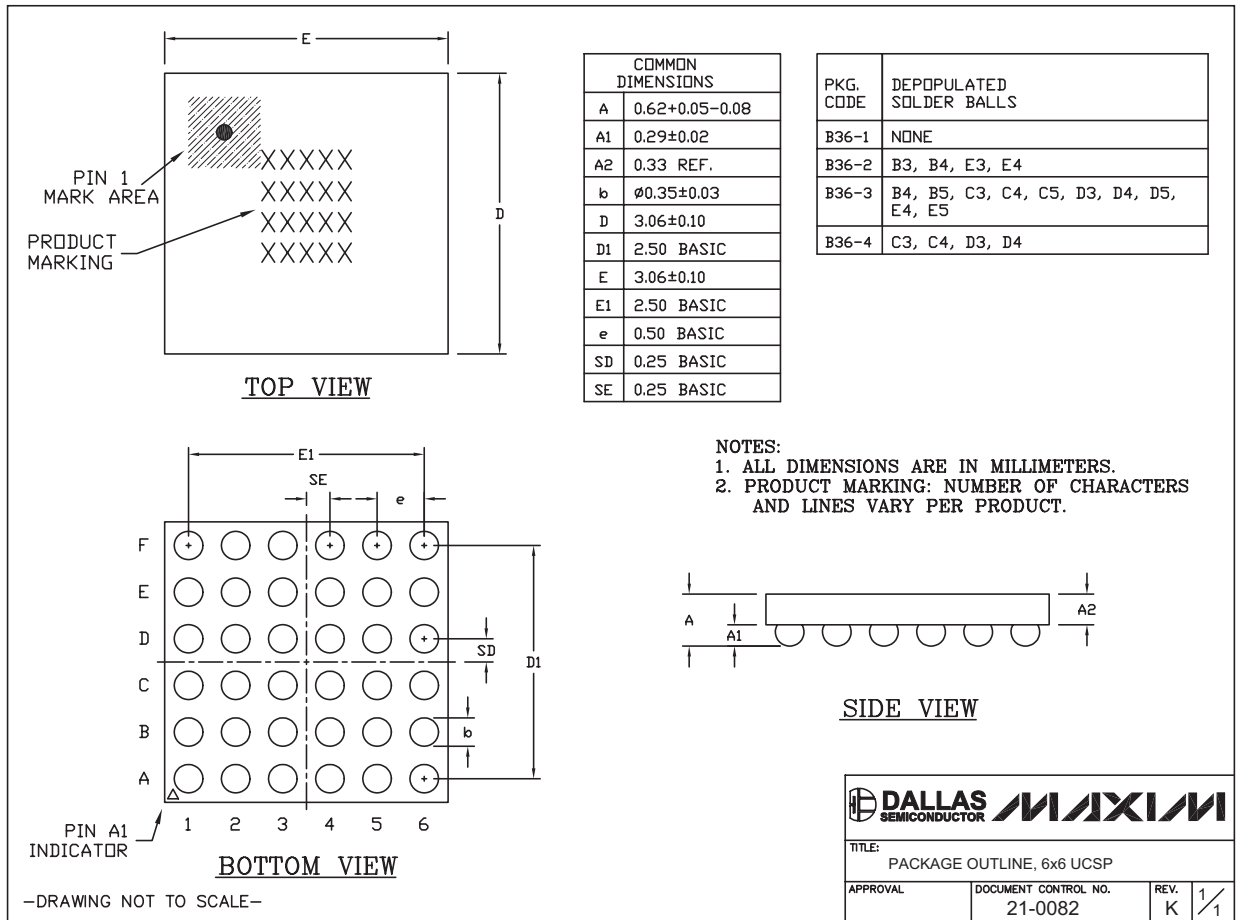

## Revision History

Pages changed at Rev 1: 1, 7, 27, 28, 37

Maxim cannot assume responsibility for use of any circuitry other than circuitry entirely embodied in a Maxim product. No circuit patent licenses are implied. Maxim reserves the right to change the circuitry and specifications without notice at any time.

Maxim Integrated Products, 120 San Gabriel Drive, Sunnyvale, CA 94086 408-737-7600 37