

FEATURES

- -55° to +125°C operation
- 16 to 40 VDC input
(19 to 40 VDC for 15 volt outputs)
- Fully Isolated
- Optocoupler feedback
- Fixed frequency 600 kHz typical
- Forward converter topology
- 50 V for up to 50 ms transient protection
- Inhibit function
- Indefinite short circuit protection
- Up to 83% efficiency, 22 W/in³

DC/DC CONVERTERS 28 VOLT INPUT

MHF SERIES 12 WATT



Size (max.): 1.460 x 1.130 x 0.330 inches (37.08 x 28.70 x 8.38 mm)
See Section B8, case E1 for dimensions.
Weight: 21 grams typical.
Screening: Standard or ES.
See section C2 for screening options.

MODELS	
VDC OUTPUT	
SINGLE	DUAL
5	±12
12	±15
15	

DESCRIPTION

The MHF Series™ of DC/DC converters offer up to 12 watts of power from single or dual outputs in a single package over a the full military temperature range. Thick film hybrid manufacturing technology produces high levels of miniaturization, giving the MHF Series converters a low profile (0.330 inch), small board area (1.65 square inches), and high power density (22 watt/in³).

The parts are packaged in hermetically sealed steel enclosures, making them ideal for use in military, aerospace, and high reliability industrial applications.

DESIGN METHODOLOGY

The MHF converters are switching regulators which use a quasi-square wave, single ended forward converter design with a nominal switching frequency of 600 kHz. Isolation between input and output circuits is provided with a transformer in the forward power loop and a temperature insensitive optical link in the feedback control loop. Output regulation is accomplished with constant frequency pulse width modulation. Both line and load regulation are typically within 10 mV.

On dual output models, the positive output is independently regulated and the negative output is cross-regulated. Figures 7 and 8 illustrate what effects load changes have on the negative output.

Indefinite short circuit protection and overload protection are provided by sensing output load current and restricting the output current to approximately 125% of full load output current. Since the output current is sensed in the secondary stage, the result is a predictable, constant output current control with no foldback characteristics. MHF converters are provided with internal filtering

elements on both the input and output to help reduce the need for external components. For information about filtering to meet MIL-STD-461's CE03 test, contact your Interpoint representative.

WIDE VOLTAGE RANGE

The MHF Series is designed to provide full power operation over the input voltage range of 16 to 40 volts. The 15 volt models provide a 19 to 40 volt range. Operation below 16 volts (or 19 volts for the 15 volt models), including operation in MIL-STD-704E emergency power conditions, is possible with derated output power. Please refer to the low line drop-out graphs, Figures 9 and 10.

MILITARY TEMPERATURE RANGE

The MHF Series provides full power operation at case temperatures from -55°C up to +125°C. All 12 and 15 volt models in both single and dual output configurations provide full power operation at +125°C with derated power to 135°C. The +5 volt model provides full power at 110°C derated to 0% at 130°C. Depending on operating levels, air flow, and ambient temperature; heat sinking may be required.

INHIBIT FEATURE

An inhibit terminal is provided that can be used to disable internal switching, resulting in a very low quiescent input current. An open collector TTL compatible low ($\leq 0.8V$) is required to control the inhibit function. This level may be supplied by an open collector gate since the inhibit pin is provided with an internal pull-up resistor.

MHF SERIES 12 WATT

DC/DC CONVERTERS

ABSOLUTE MAXIMUM RATINGS	
Input Voltage	• 16 to 40 VDC (19 to 40 VDC 15 volt output)
Output Power	• 12 watts (10 watts MHF2805S)
Lead Soldering Temperature (10 sec per lead)	• 300°C
Storage Temperature Range (Case)	• -55°C to +135°C

INHIBIT	
Inhibit TTL Open Collector	<ul style="list-style-type: none"> • Logic low (output disabled) Logic low 0.8 V max Inhibit pin current 4 mA max • Referenced to input common • Logic high (output enabled) Open collector

TYPICAL CHARACTERISTICS	
Output Voltage Temperature Coefficient	• 150 ppm/°C, typical
Input to Output Capacitance	• 50 pF, typical
Current Limit	• 125% of full load, typical
Isolation	• 100 megohm minimum at 500 V
Conversion Frequency	• 600 kHz typical
Inhibit Pin Voltage (unit enabled)	• 8 to 11 V

RECOMMENDED OPERATING CONDITIONS	
Input Voltage Range	<ul style="list-style-type: none"> • 16 to 40 VDC continuous • 19 to 40 VDC 15 volt outputs continuous • 50 V for 50 msec transient
Case Operating Temperature (Tc)	<ul style="list-style-type: none"> • -55°C to +125°C full power • -55°C to +110°C full power for MHF2805S • -55°C to +135°C absolute • -55°C to +130°C absolute for MHF2805S
Derating Output Power/Current	<ul style="list-style-type: none"> • Linearly from 100% at 125°C to 0% at 135°C • Linearly from 100% at 110°C to 0% at 130°C for MHF2805S

Electrical Characteristics: 25°C Tc, 28 VDC Vin, 100% load, unless otherwise specified.

SINGLE OUTPUT MODELS		MHF2805S			MHF2812S			MHF2815S			UNITS
PARAMETER	CONDITIONS	MIN	TYP	MAX	MIN	TYP	MAX	MIN	TYP	MAX	
OUTPUT VOLTAGE		4.95	5.0	5.05	11.88	12	12.12	14.85	15	15.15	VDC
OUTPUT CURRENT		—	—	2.0	—	—	1.0	—	—	0.8	A
OUTPUT POWER	MIN. TO MAX. V _{IN}	—	—	10	—	—	12	—	—	12	W
OUTPUT RIPPLE	10 kHz to 2 MHz	—	40	60	—	30	60	—	25	50	mV p-p
LINE REGULATION	MIN. TO MAX. V _{IN}	—	10	50	—	10	50	—	10	50	mV
LOAD REGULATION	NO LOAD TO FULL	—	10	50	—	10	50	—	10	50	mV
INPUT VOLTAGE	CONTINUOUS	16	28	40	16	28	40	19	28	40	VDC
	TRANSIENT 50 ms	—	—	50	—	—	50	—	—	50	V
INPUT CURRENT	NO LOAD	—	20	30	—	20	30	—	20	30	mA
	FULL LOAD	—	—	483	—	—	557	—	—	535	
	INHIBITED	—	2	3	—	2	3	—	2	3	
INPUT RIPPLE CURRENT	10 kHz TO 2 MHz	—	135	180	—	150	200	—	150	220	mA p-p
EFFICIENCY		74	77	—	77	81	—	80	83	—	%
LOAD FAULT ¹	POWER DISSIPATION OVERLOAD	—	—	5	—	—	5	—	—	5	W
	SHORT CIRCUIT	—	—	3.5	—	—	2.8	—	—	2	
START-UP	DELAY	—	180	300	—	80	200	—	150	250	ms

Notes

1. Indefinite short circuit protection not guaranteed above 125°C case temperature (110°C case for MHF2805S).

DC/DC CONVERTERS

MHF SERIES 12 WATT

Electrical Characteristics: 25°C Tc, 28 VDC Vin, 100% load, unless otherwise specified.

DUAL OUTPUT MODELS		MHF2812D			MHF2815D			UNITS
PARAMETER	CONDITION	MIN	TYP	MAX	MIN	TYP	MAX	
OUTPUT VOLTAGE	+V _{OUT}	11.88	12.0	12.12	14.85	15.0	15.15	VDC
	-V _{OUT}	11.82	12.0	12.18	14.77	15.0	15.23	
OUTPUT CURRENT ^{1, 2}		—	0.5	1.0	—	0.4	0.8	A
OUTPUT POWER ²	+V _{OUT}	—	—	10.8	—	—	10.8	W
	-V _{OUT}	—	—	10.8	—	—	10.8	
	TOTAL	—	—	12	—	—	12	
OUTPUT RIPPLE VOLTAGE	10 kHz TO 2 MHz	—	30	60	—	30	60	mV p-p
LINE REGULATION								
MIN. TO MAX. V _{IN}	+V _{OUT}	—	5	50	—	5	50	mV
LOAD REGULATION								
NO LOAD TO FULL	+V _{OUT}	—	5	50	—	10	50	mV
CROSS REGULATION	20% TO 80% LOAD ³	—	5	10	—	4	8	%
	50% LOAD ⁴	—	4	5	—	3	5	
INPUT VOLTAGE	CONTINUOUS	16	28	40	19	28	40	VDC
NO LOAD TO FULL	TRANSIENT 50 ms	—	—	50	—	—	50	V
INPUT CURRENT	NO LOAD	—	25	35	—	25	35	mA
	FULL LOAD	—	—	550	—	—	536	
	INHIBITED	—	1.9	3	—	1.9	3	
INPUT RIPPLE CURRENT	10 kHz TO 2 MHz	—	175	240	—	175	240	mA p-p
EFFICIENCY		78	81	—	80	83	—	%
LOAD FAULT ⁵	POWER DISSIPATION							W
	SHORT CIRCUIT	—	—	2.8	—	—	2	
	OVERLOAD	—	—	5	—	—	5	
START-UP	DELAY	—	150	250	—	150	250	ms

Notes

- Applies to both outputs.
- Maximum combined output power is 12 watts. A maximum of 90% is available from either output.
- 20% to 80% load on the positive output and 80% to 20% on the negative output. See Figure 8.
- 50% load on the positive output and 50% to 20% load on the negative output. 50% load on the negative output and 50% to 20% load on the positive output. See Figure 7.
- Indefinite short circuit protection not guaranteed above 125°C case temperature.

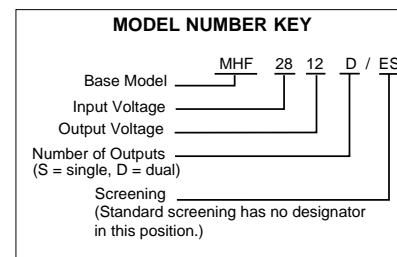
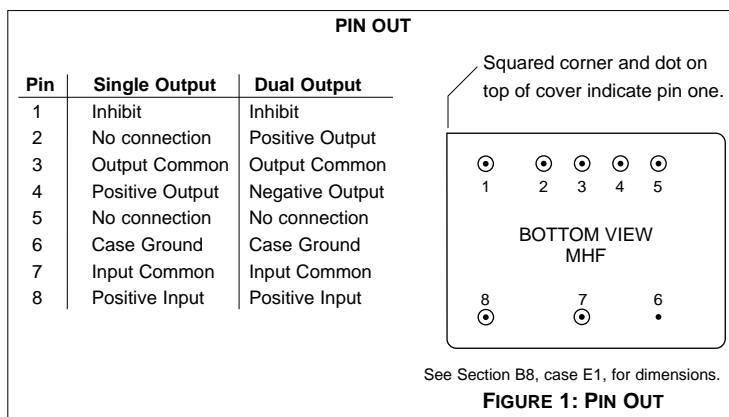

MHF SERIES 12 WATT

DC/DC CONVERTERS

Typical Performance Curves: 25°C Tc , 28 VDC Vin, 100% load, unless otherwise specified.

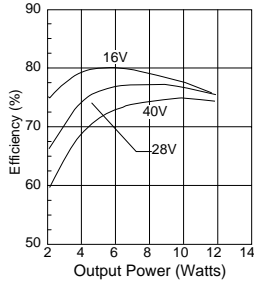

MHF2805S Efficiency
FIGURE 2

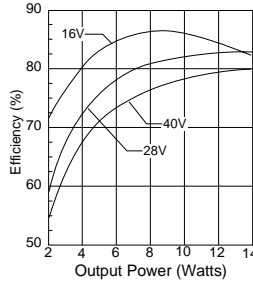

MHF2812S Efficiency
FIGURE 3

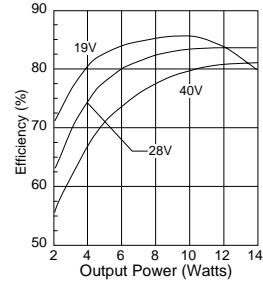

MHF2815S Efficiency
FIGURE 4

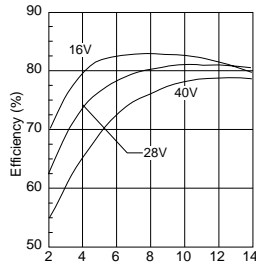

MHF2812D Efficiency
FIGURE 5

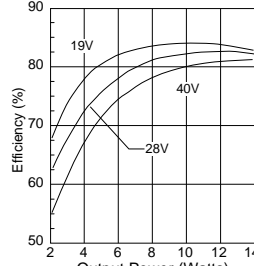

MHF2815D Efficiency
FIGURE 6

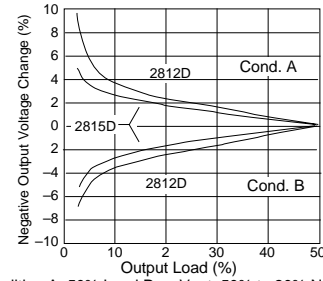

Condition A: 50% Load Pos. Vout, 50% to 20% Neg. Vout
Condition B: 50% Load Neg. Vout, 50% to 20% Pos. Vout
MHF Negative Output Voltage
Cross Regulation
FIGURE 7

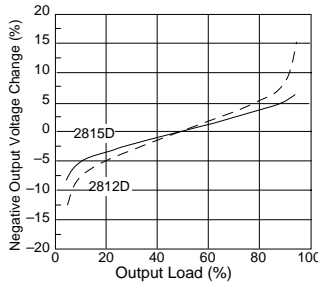

Positive Output 20% to 80% Load
Negative Output 80% to 20% Load
MHF Dual Negative Output Voltage
Cross Regulation
FIGURE 8

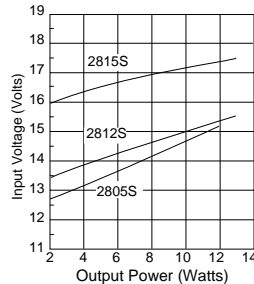

MHF Single Low Line Dropout
FIGURE 9

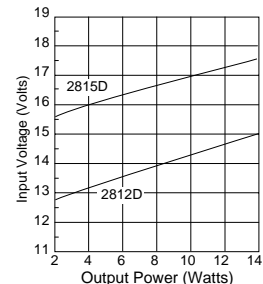

MHF Dual Low Line Dropout
FIGURE 10

218211-001-DTS Rev A DQ# 1011

All technical information is believed to be accurate, but no responsibility is assumed for errors or omissions. Interpoint reserves the right to make changes in products or specifications without notice. MHF Series is a trademark of Interpoint. Copyright © 1992 - 1999 Interpoint. All rights reserved.

CASE E

CASES

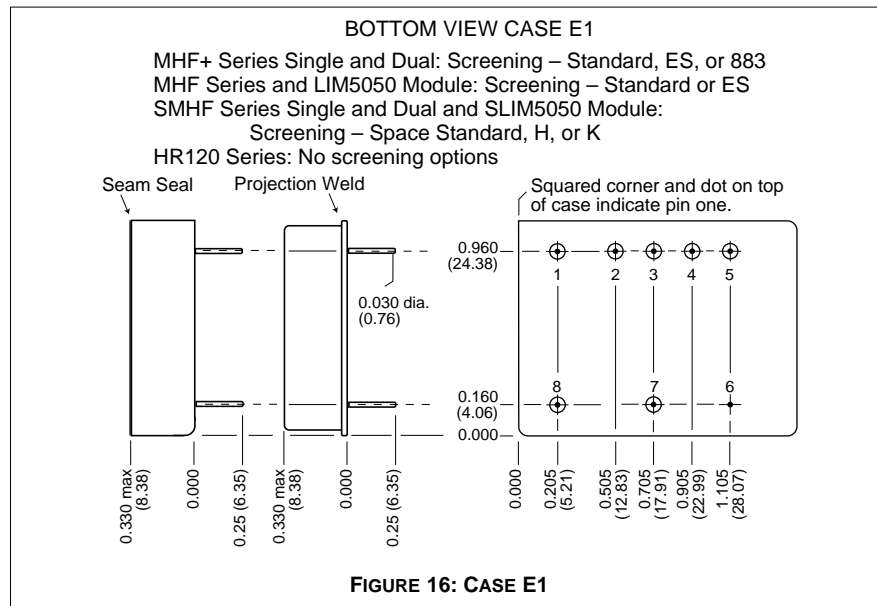
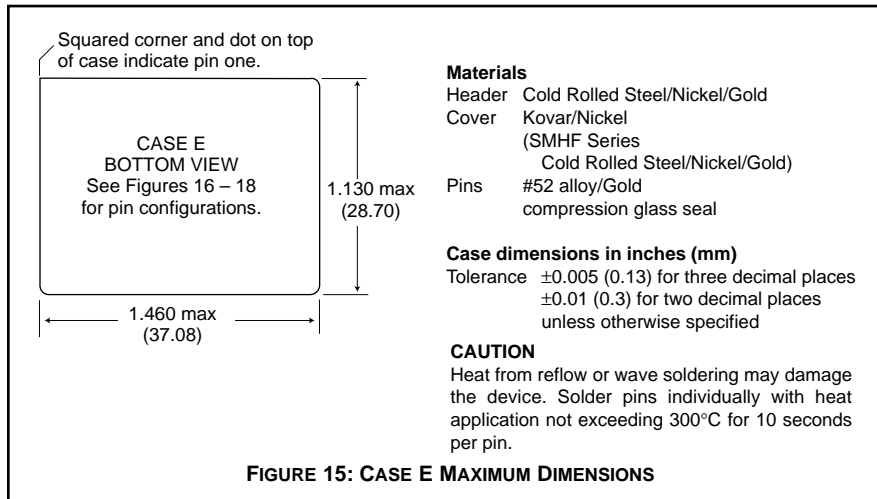

Note: Although every effort has been made to render the case drawings at actual size, variations in the printing process may cause some distortion. Please refer to the numerical dimensions for accuracy.

QA SCREENING 125°C PRODUCTS

125°C PRODUCTS

TEST (125°C Products)	STANDARD	/ES	/883 (Class H)*
PRE-CAP INSPECTION Method 2017, 2032	yes	yes	yes
TEMPERATURE CYCLE (10 times) Method 1010, Cond. C, -65°C to 150°C Method 1010, Cond. B, -55°C to 125°C	no no	no yes	yes no
CONSTANT ACCELERATION Method 2001, 3000 g Method 2001, 500 g	no no	no yes	yes no
BURN-IN Method 1015, 160 hours at 125°C 96 hours at 125°C case (typical)	no no	no yes	yes no
FINAL ELECTRICAL TEST MIL-PRF-38534, Group A Subgroups 1 through 6: -55°C, +25°C, +125°C Subgroups 1 and 4: +25°C case	no yes	no yes	yes no
HERMETICITY TESTING Fine Leak, Method 1014, Cond. A Gross Leak, Method 1014, Cond. C Gross Leak, Dip (1 x 10 ⁻³)	no no yes	yes yes no	yes yes no
FINAL VISUAL INSPECTION Method 2009	yes	yes	yes

Test methods are referenced to MIL-STD-883 as determined by MIL-PRF-38534.

*883 products are built with element evaluated components and are 100% tested and guaranteed over the full military temperature range of -55°C to +125°C.

Applies to the following products

MOR Series	MHD Series	MGH Series	FMGA EMI Filter
MFLHP Series	MHV Series	MCH Series	FMSA EMI Filter
MFL Series	MHF+ Series	FM-704A EMI Filter	HUM Modules**
MHP Series	MHF Series**	FMD**/FME EMI Filter	LCM Modules**
MTR Series	MGA Series	FMC EMI Filter	LIM Modules
MQO Series**	MSA Series	FMH EMI Filter	

**MFLHP Series, MQO Series, MHF Series, FMD EMI Filters, Hum Modules, and LCM Modules do not offer '883' screening.