



# ULTRA HIGH VOLTAGE OPERATIONAL AMPLIFIER

# 166/167

M.S.KENNEDY CORP.

4707 Dey Road Liverpool, N.Y. 13088

(315) 701-6751

**FEATURES:**

- Low Cost Surface Mount Package
- Monolithic MOS Technology
- High Voltage Operation - 350V
- Low Quiescent Current - 2mA Max.
- High Output Current - 60mA Min.
- No Second Breakdown
- High Speed - 40V/ $\mu$ S Typ.
- External Compensation And Null Capability

**MIL-PRF-38534 QUALIFIED**

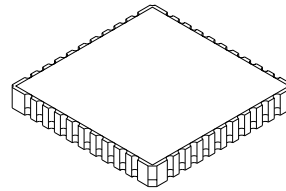

**MSK166**

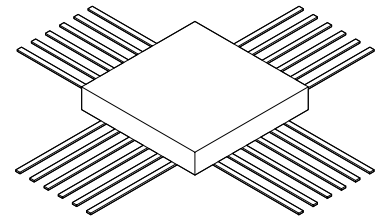

**MSK167**

**DESCRIPTION:**

The MSK 166 and 167 ultra high voltage monolithic MOSFET operational amplifier ideally suited for electrostatic transducer and electrostatic deflection applications. With a total supply voltage rating of 350 volts and 60mA of available output current, the MSK 166 and 167 are also an excellent low cost choice for high voltage piezo drive circuits. The MOSFET output frees the MSK 166 and 167 from secondary breakdown limitations and power dissipation is kept to a minimum with a quiescent current rating of only 2mA. The MSK 166 is packaged in a hermetically sealed 40 pin leadless chip carrier which has two external compensation pins. The output of the MSK 166 and 167 can be externally nulled using the two null pins. The MSK 167 is packaged in a 24 pin ceramic flatpack and is otherwise identical to the MSK 166. (see mechanical specifications).

**EQUIVALENT SCHEMATIC**

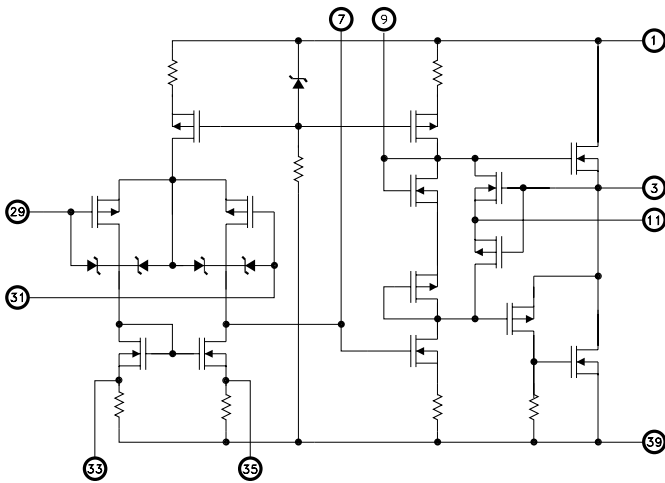

The pin numbers shown in the above schematic are for the MSK 166.

**PIN-OUT INFORMATION**

**MSK 166 PINOUT**

1 +Vcc	40 N/C
2 N/C	39 -Vcc
3 Output Drive	38 N/C
4 N/C	37 N/C
5 N/C	36 N/C
6 N/C	35 Balance 2
7 Compensation 1	34 N/C
8 N/C	33 Balance 1
9 Compensation 2	32 N/C
10 N/C	31 Non Inverting Input
11 Current Sense	30 N/C
12 N/C	29 Inverting Input
13 N/C	28 N/C
14 N/C	27 N/C
15 N/C	26 N/C
16 N/C	25 N/C
17 N/C	24 N/C
18 N/C	23 N/C
19 N/C	22 N/C
20 N/C	21 N/C

**MSK 167 PINOUT**

1 N/C	24 N/C
2 Balance 1	23 Non Inverting Input
3 Balance 2	22 Inverting Input
4 N/C	21 N/C
5 -Vcc	20 N/C
6 N/C	19 N/C
7 +Vcc	18 N/C
8 Output Drive	17 N/C
9 N/C	16 N/C
10 Compensation 1	15 N/C
11 Compensation 2	14 Current Sense
12 N/C	13 N/C

**TYPICAL APPLICATIONS**

- Piezo Electric Positioning
- Electrostatic Deflection
- Computer to Vacuum Tube Interface
- Ultra High Voltage Op-Amp Applications

## ABSOLUTE MAXIMUM RATINGS

$V_{CC}$ ②	Total Supply Voltage . . . . .	350V	$T_{ST}$	Storage Temperature . . . . .	-65°C to +150°C
$\pm I_{OUT}$	Output Current (within S.O.A.) . . . . .	60mA	$T_{LD}$	Lead Temperature . . . . .	300°C
$\pm I_{OUTP}$	Output Current Peak . . . . .	120mA	$T_C$	Case Operating Temperature (MSK166B/167B) . . . . .	-55°C to +125°C
$V_{IND}$	Input Voltage (Differential) . . . . .	$\pm 16V$		(MSK166/167) . . . . .	-40°C to +85°C
$V_{IN}$	Input Voltage (Common Mode) . . . . .	$\pm V_{CC}$	$R_{TH}$	Thermal Resistance (DC) Junction to Case . . . . .	15°C/W
$T_J$	Junction Temperature . . . . .	150°C			

## ELECTRICAL SPECIFICATIONS

Parameter	Test Conditions ①	Group A Subgroup	MSK166B/167B			MSK166/167			Units
			Min.	Typ.	Max.	Min.	Typ.	Max.	
<b>STATIC</b>									
Supply Voltage Range ② ④ ⑨		-	$\pm 50$	$\pm 150$	$\pm 175$	$\pm 50$	$\pm 150$	$\pm 175$	V
Quiescent Current	$V_{IN} = 0V$	1	-	$\pm 1.4$	$\pm 2.0$	-	$\pm 1.4$	$\pm 2.0$	mA
		2	-	$\pm 2.0$	$\pm 3.0$	-	-	-	mA
		3	-	$\pm 1.0$	$\pm 2.1$	-	-	-	mA
<b>INPUT</b>									
Offset Voltage	$V_{IN} = 0V$	1	-	$\pm 15$	$\pm 30$	-	$\pm 15$	$\pm 30$	mV
Offset Voltage Drift ④	$V_{IN} = 0V$	2,3	-	$\pm 40$	$\pm 65$	-	$\pm 40$	-	$\mu V/^\circ C$
Offset Voltage vs $\pm V_{CC}$ ④	$V_{IN} = 0V$	1	-	$\pm 20$	$\pm 32$	-	$\pm 20$	$\pm 32$	$\mu V/V$
Input Bias Current ④	$V_{CM} = 0V$	1,3	-	$\pm 5$	$\pm 50$	-	$\pm 5$	$\pm 100$	pA
		2	-	-	$\pm 50$	-	-	-	nA
Input Impedance ④	(DC)	-	-	$10^{11}$	-	-	$10^{11}$	-	$\Omega$
Input Capacitance ④		-	-	5	-	-	5	-	pF
Common Mode Rejection ④	$V_{CM} = \pm 90VDC$	-	84	94	-	84	94	-	dB
Noise	$1Hz \leq f \leq 10Hz$	-	-	50	-	-	50	-	$\mu VRMS$
<b>OUTPUT</b>									
Output Voltage Swing	$I_{OUT} = \pm 40mA$ Peak	4	$\pm 138$	$\pm 141$	-	$\pm 138$	$\pm 141$	-	V
Output Current	$V_{OUT} = MAX$	4	$\pm 60$	$\pm 120$	-	$\pm 60$	$\pm 120$	-	mA
Power Bandwidth ④	$C_C = 10pF$ $V_{OUT} = 280V_{PP}$	-	-	26	-	-	26	-	KHz
Resistance ④	No Load, $R_{CL} = 0\Omega$	-	-	150	-	-	150	-	$\Omega$
Settling Time to 0.1% ③ ④	$C_C = 10pF$ 10V Step	-	-	12	-	-	12	-	$\mu S$
Capacitive Load ④	$A_V = +1V/V$	-	10	-	-	10	-	-	nF
<b>TRANSFER CHARACTERISTICS</b>									
Slew Rate	$C_C = Open$	4	20	40	-	20	40	-	$V/\mu S$
Open Loop Voltage Gain ④	$F = 15Hz$ $R_L = 5K\Omega$	4	94	106	-	94	106	-	dB

### NOTES:

- ① Unless otherwise noted  $C_C = 18pF$ ,  $R_C = 2.2K\Omega$ ,  $\pm V_{CC} = \pm 150VDC$ , null pins one and two are no connect.
- ② Derate maximum supply voltage 0.5V/°C below  $T_C = +25^\circ C$ . No derating is needed above  $T_C = 25^\circ C$ .
- ③  $A_V = -10V/V$  measured in false summing junction circuit.
- ④ Devices shall be capable of meeting the parameter, but need not be tested. Typical parameters are for reference only.
- ⑤ Industrial grade devices shall be tested to subgroups 1 and 4 unless otherwise requested.
- ⑥ Military grade devices ('B' suffix) shall be 100% tested to subgroups 1,2,3 and 4.
- ⑦ Subgroup 5 and 6 testing available upon request.
- ⑧ Subgroup 1,4  $T_C = +25^\circ C$   
Subgroup 2,5  $T_C = +125^\circ C$   
Subgroup 3,6  $T_A = -55^\circ C$
- ⑨ Electrical specifications are derated for power supply voltages less than  $\pm 50VDC$ .

## APPLICATION NOTES

### CURRENT LIMIT

Current limit resistor value can be calculated as follows:

$$R_{CL} = 3/I_{LIM}$$

It is recommended that the user set up the value of current limit as close as possible to the maximum expected output current to protect the amplifier. The minimum value of current limit resistance is 33 ohms. The maximum practical value is 500 ohms. Current limit will vary with case temperature. Refer to the typical performance graphs as a guide. Since load current passes through the current limit resistor, a loss in output voltage swing will occur. The following formula approximates output voltage swing reduction:

$$V_R = I_O * R_{CL}$$

When the device is in current limit, there will be spurious oscillations present on the negative half cycle. The frequency of the oscillation is application dependant and can not be predicted. Oscillation will cease when the device comes out of current limit. If current limit is not required simply short pin 3 and pin 11.

### INPUT PROTECTION

Input protection circuitry within the MSK 166/167 will clip differential input voltages greater than 16 volts. The inputs are also protected against common mode voltages up to the supply rails as well as static discharge. There are 300 ohm current limiting resistors in series with each input. These resistors may become damaged in the event the input overload is capable of driving currents above 1mA. If severe overload conditions are expected, external input current limiting resistors are recommended.

### OUTPUT SNUBBER NETWORK

A 100 ohm resistor and a 330pF capacitor connected in series from the output of the amplifier to ground is recommended for applications where load capacitance is less than 330pF. For larger values of load capacitance, the output snubber network may be omitted. If loop stability becomes a problem due to excessively high load capacitance, a 100 ohm resistor may be added between the output of the amplifier and the load. A small tradeoff with bandwidth must be made in this configuration. The graph below illustrates the effect of capacitive load on open loop gain. Note that the compensation capacitor must have a voltage rating greater than or equal to the total rail to rail power supply voltage.

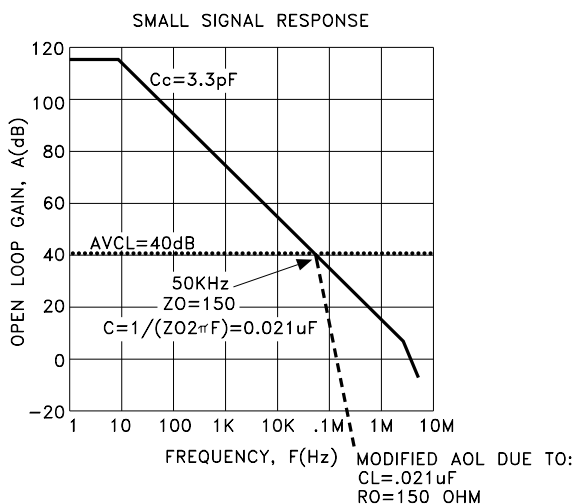

### SAFE OPERATING AREA (SOA)

The MOSFET output stage of this ultra high voltage operational amplifier has two distinct limitations:

1. The current handling capability of the die metallization.
2. The junction temperature of the output MOSFET's.

NOTE: The output stage is protected against transient flyback. However, for protection against sustained, high energy flyback, external fast-recovery reverse biased diodes should be connected from the output to ground.

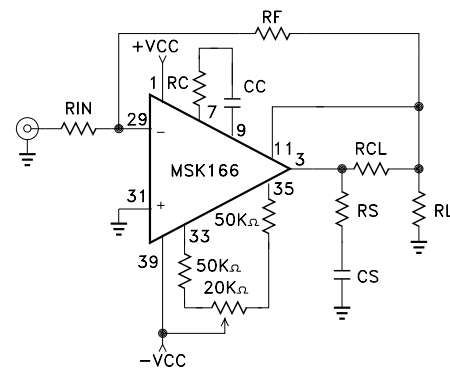
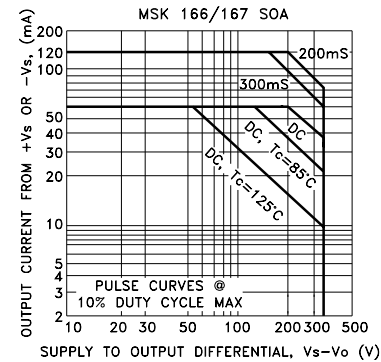

### STABILITY

The MSK 166/167 has sufficient phase margin when compensated for unity gain to be stable with capacitive loads of at least 10nF. However, it is recommended that the parallel sum of the input and feedback resistor be 1000 ohms or less for closed loop gains of ten or less to minimize phase shift caused by the R-C network formed by the input resistor, feedback resistor and input capacitance. The user can tailor the performance of the MSK 166/167 to their application using the external compensation pins. The graphs of small signal gain and phase as well as the graphs of slew rate and power response demonstrate the effect of various forms of compensation. The compensation capacitor must be rated at 350 volts working voltage if maximum power supply voltages are used. The compensation resistor and capacitor lead lengths must be kept as short as possible to minimize spurious oscillations. A high quality NPO capacitor rated for ±Vcc is recommended for the compensation capacitor.

### COMPENSATION AND OUTPUT NULL PINS

External compensation is only necessary at gains of 30v/v or less. For larger gains, the compensation resistor and capacitor may be omitted. When large closed loop voltage gains are present, the designer may find it necessary to null the DC output offset voltage. This can be accomplished by connecting a null circuit to pins 33 and 35 (for the MSK 166) as shown in the typical connection diagram above.

# TYPICAL PERFORMANCE CURVES

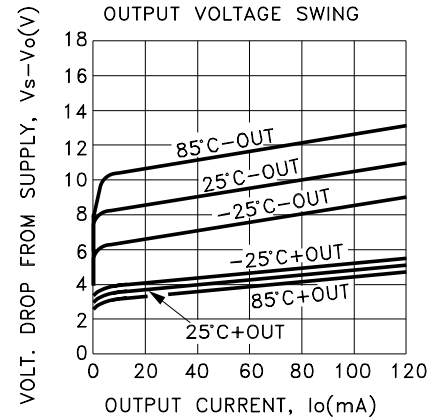
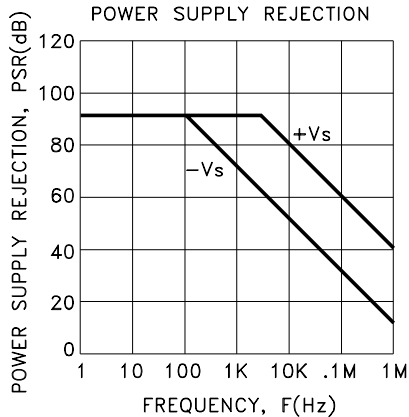
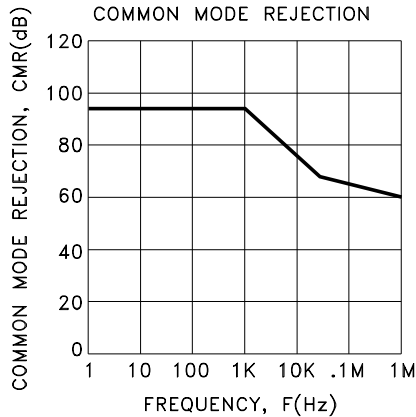
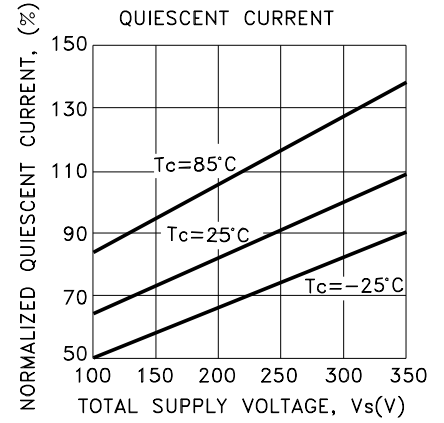
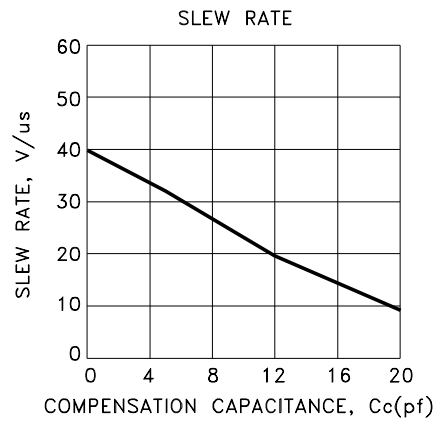
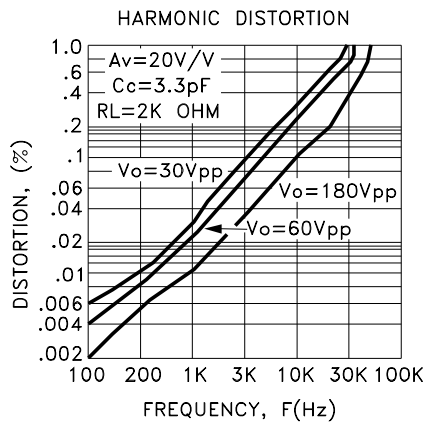
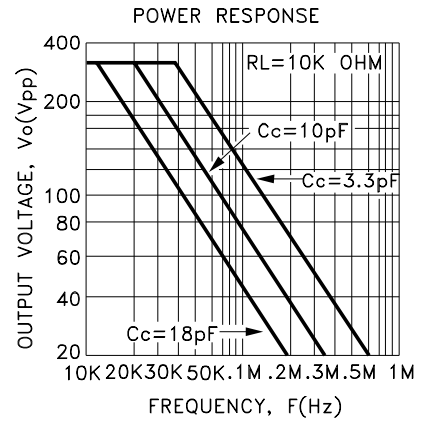
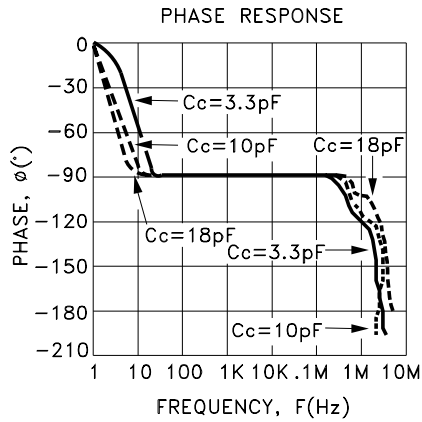
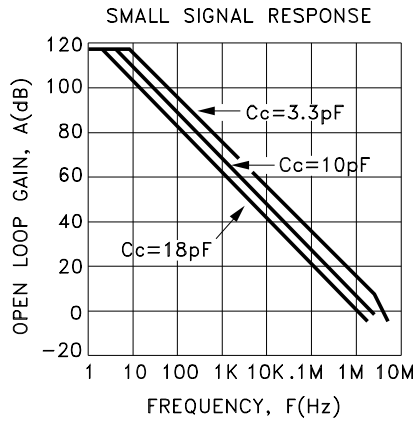
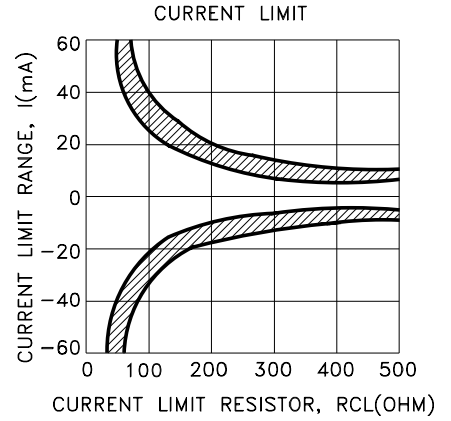
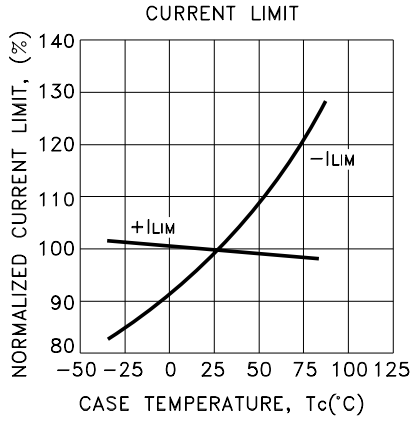
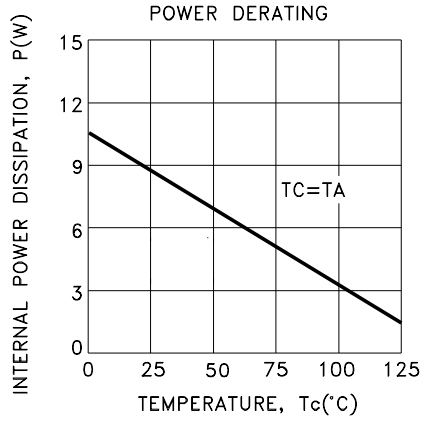

# MECHANICAL SPECIFICATIONS

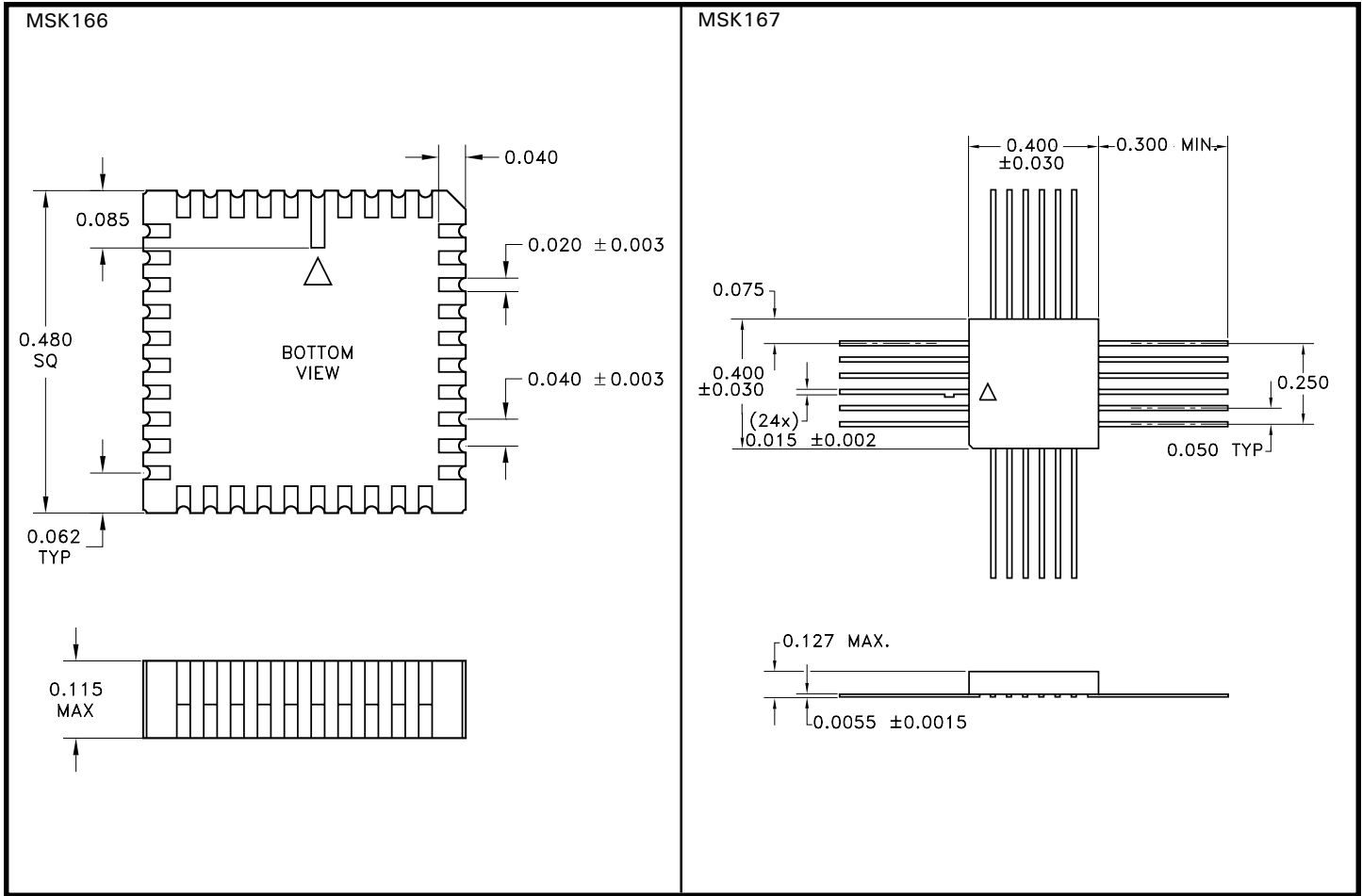

ESD TRIANGLE INDICATES PIN 1.  
ALL DIMENSIONS ARE  $\pm 0.010$  INCHES UNLESS OTHERWISE LABELED.

## ORDERING INFORMATION

Part Number	Screening Level
MSK166	Industrial
MSK166B	Military-Mil-PRF-38534
MSK167	Industrial
MSK167B	Military-Mil-PRF-38534

M.S. Kennedy Corp.  
4707 Dey Road, Liverpool, New York 13088  
Phone (315) 701-6751  
FAX (315) 701-6752  
www.mskennedy.com

The information contained herein is believed to be accurate at the time of printing. MSK reserves the right to make changes to its products or specifications without notice, however, and assumes no liability for the use of its products.