

DOUBLE DATA RATE (DDR) SDRAM

MT46V2M32V1- 512K x 32 x 4 banks
MT46V2M32 - 512K x 32 x 4 banks

For the latest data sheet revisions, please refer to the Micron
Web site: www.micron.com/dramds

FEATURES

- Bidirectional data strobe (DQS) transmitted/ received with data, i.e., source-synchronous data capture
- Internal, pipelined double-data-rate (DDR) architecture; two data accesses per clock cycle
- Reduced output drive option
- Differential clock inputs (CK and CK#)
- Commands entered on each positive CK edge
- DQS edge-aligned with data for READS; center-aligned with data for WRITES
- DLL to align DQ and DQS transitions with CK
- Four internal banks for concurrent operation
- Data mask (DM) for masking write data
- Programmable burst lengths: 2, 4, 8, or full page
- 32ms, 4,096-cycle auto refresh (7.8µs/cycle)
- Auto precharge option
- Auto Refresh and Self Refresh Modes
- Programmable I/O (SSTL_2 compatible) – reduced and impedance matched

OPTIONS

- Configuration
2 Meg x 32 (512K x 32 x 4 banks)
- Power Supply
2.5V V_{DD}/V_{DDQ}
2.65V V_{DD}/V_{DDQ}
- Plastic Package
100-pin TQFP (0.65mm lead pitch)
- Timing - Cycle Time
200 MHz @ CL = 3 -5
183 MHz @ CL = 3 -55
166 MHz @ CL = 3 -6
150 MHz @ CL = 3 -65

MARKING

2M32
V1
none
LG
-5
-55
-6
-65

Part Number Example:

MT46V2M32V1LG-5

64Mb (x32) DDR SDRAM PART NUMBER

PART NUMBER	ARCHITECTURE
MT46V2M32LG	2 Meg x 32

PIN ASSIGNMENT (TOP VIEW) 100-Pin TQFP (Normal Bend Shown)

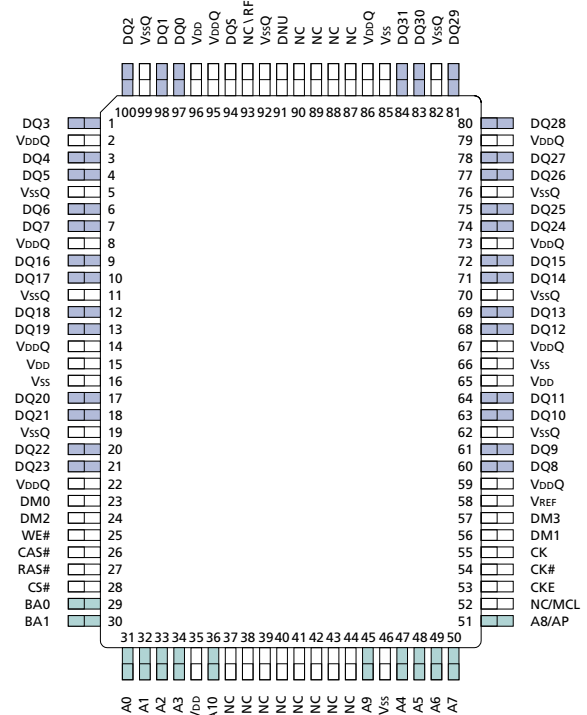

2 Meg x 32	
Configuration	512K x 32 x 4 banks
Refresh Count	4K
Row Addressing	2K (A0-A10)
Bank Addressing	4 (BA0, BA1)
Column Addressing	256 (A0-A7)

KEY TIMING PARAMETERS

SPEED GRADE	CLOCK RATE		DATA-OUT WINDOW*	ACCESS WINDOW	DQS-DQ SKEW
	CL = 2**	CL = 3**			
-5	125 MHz	200 MHz	1.5ns	±0.75ns	+0.5ns
-55	100 MHz	183 MHz	1.8ns	±0.75ns	+0.5ns
-6	100 MHz	166 MHz	1.9ns	±0.75ns	+0.5ns
-65	100 MHz	150 MHz	2.1ns	±0.75ns	+0.5ns

*Minimum clock rate @ CL = 3

**CL = CAS (Read) Latency

GENERAL DESCRIPTION

The 64Mb (x32) DDR SDRAM is a high-speed CMOS, dynamic random-access memory containing 67,108,864 bits. It is internally configured as a quad-bank DRAM.

The 64Mb DDR SDRAM uses a double data rate architecture to achieve high-speed operation. The double data rate architecture is essentially a $2n$ -prefetch architecture with an interface designed to transfer two data words per clock cycle at the I/O pins. A single read or write access for the 64Mb DDR SDRAM effectively consists of a single $2n$ -bit wide, one-clock-cycle data transfer at the internal DRAM core and two corresponding n -bit wide, one-half-clock-cycle data transfers at the I/O pins.

A bidirectional data strobe (DQS) is transmitted externally, along with data, for use in data capture at the receiver. DQS is a strobe transmitted by the DDR SDRAM during READs and by the memory controller during WRITEs. DQS is edge-aligned with data for READs and center-aligned with data for WRITEs.

The 64Mb DDR SDRAM operates from a differential clock (CK and CK#); the crossing of CK going HIGH and CK# going LOW will be referred to as the positive edge of CK. Commands (address and control signals) are registered at every positive edge of CK. Input data is registered on both edges of DQS, and output data is referenced to both edges of DQS, as well as to both edges of CK.

Read and write accesses to the DDR SDRAM are burst oriented; accesses start at a selected location and continue for a programmed number of locations in a programmed sequence. Accesses begin with the regis-

tration of an ACTIVE command, which is then followed by a READ or WRITE command. The address bits registered coincident with the ACTIVE command are used to select the bank and row to be accessed. The address bits registered coincident with the READ or WRITE command are used to select the bank and the starting column location for the burst access.

The DDR SDRAM provides for programmable READ or WRITE burst lengths of 2, 4, 8, or full page locations. An auto precharge function may be enabled to provide a self-timed row precharge that is initiated at the end of the burst access.

As with standard SDR SDRAMs, the pipelined, multibank architecture of DDR SDRAMs allows for concurrent operation, thereby providing high effective bandwidth by hiding row precharge and activation time.

An auto refresh mode is provided, along with a power-saving power-down mode. All inputs are compatible with the JEDEC Standard for SSTL_2. All outputs are SSTL_2.

- NOTE:**
1. The functionality and the timing specifications discussed in this data sheet are for the DLL-enabled mode of operation.
 2. Throughout the data sheet, the various figures and text refer to DQs as "DQ." The DQ term is to be interpreted as any and all DQ collectively, unless specifically stated otherwise.

TABLE OF CONTENTS

Functional Block Diagram - 2 Meg x 32	4	Random Writes	28
Pin Descriptions	5	Write to Read - Uninterrupting	29
Functional Description	7	Write to Read - Interrupting	30
Initialization	7	Write to Read - Odd, Interrupting	31
Register Definition	7	Write to Precharge - Uninterrupting	32
Mode Register	7	Write to Precharge - Interrupting	33
Burst Length	7	Write to Precharge - Odd, Interrupting	34
Burst Type	8	Precharge	35
Read Latency	9	Power-Down	35
Operating Mode	9	<i>Truth Table 2 (CKE)</i>	36
Extended Mode Register	10	<i>Truth Table 3 (Current State, Same Bank)</i>	37
DLL Enable/Disable	10	<i>Truth Table 4 (Current State, Different Bank)</i>	39
Commands	11	Operating Conditions	
<i>Truth Table 1 (Commands)</i>	11	Absolute Maximum Ratings	41
<i>Truth Table 1A (DM Operation)</i>	11	DC Electrical and Operating Conditions	41
Deselect	12	AC Input Operating Conditions	41
No Operation (NOP)	12	Clock Input Operating Conditions	42
Load Mode Register	12	Capacitance	44
Active	12	IDD Specifications and Conditions	44
Read	12	AC Electrical Characteristics (Timing Table)	45
Write	12	Data Valid Window Derating	48
Precharge	12	Voltage and Timing Waveforms	
Auto Precharge	12	Nominal Output Drive Curves	47
Burst Terminate	12	Reduced Output Drive Curves	52
Auto Refresh	13	Output Timing - ^t DQSQ and ^t QH	53
Self Refresh	13	Output Timing - ^t AC and ^t DQSCK	54
Operation	14	Input Timing	54
Bank/Row Activation	14	Input Voltage	55
Reads	15	Initialize and Load Mode Registers	56
Read Burst	16	Power-Down Mode	57
Consecutive Read Bursts	17	Auto Refresh Mode	58
Nonconsecutive Read Bursts	18	Self Refresh Mode	59
Random Read Accesses	19	Reads	
Terminating a Read Burst	21	Bank Read - Without Auto Precharge	60
Read to Write	22	Bank Read - With Auto Precharge	61
Read to Precharge	23	Writes	
Writes	24	Bank Write - Without Auto Precharge	62
Write Burst	25	Bank Write - With Auto Precharge	63
Consecutive Write to Write	26	Write - DM Operation	64
Non-consecutive Write to Write	27	100-pin TQFP dimensions	65

FUNCTIONAL BLOCK DIAGRAM
2 Meg x 32

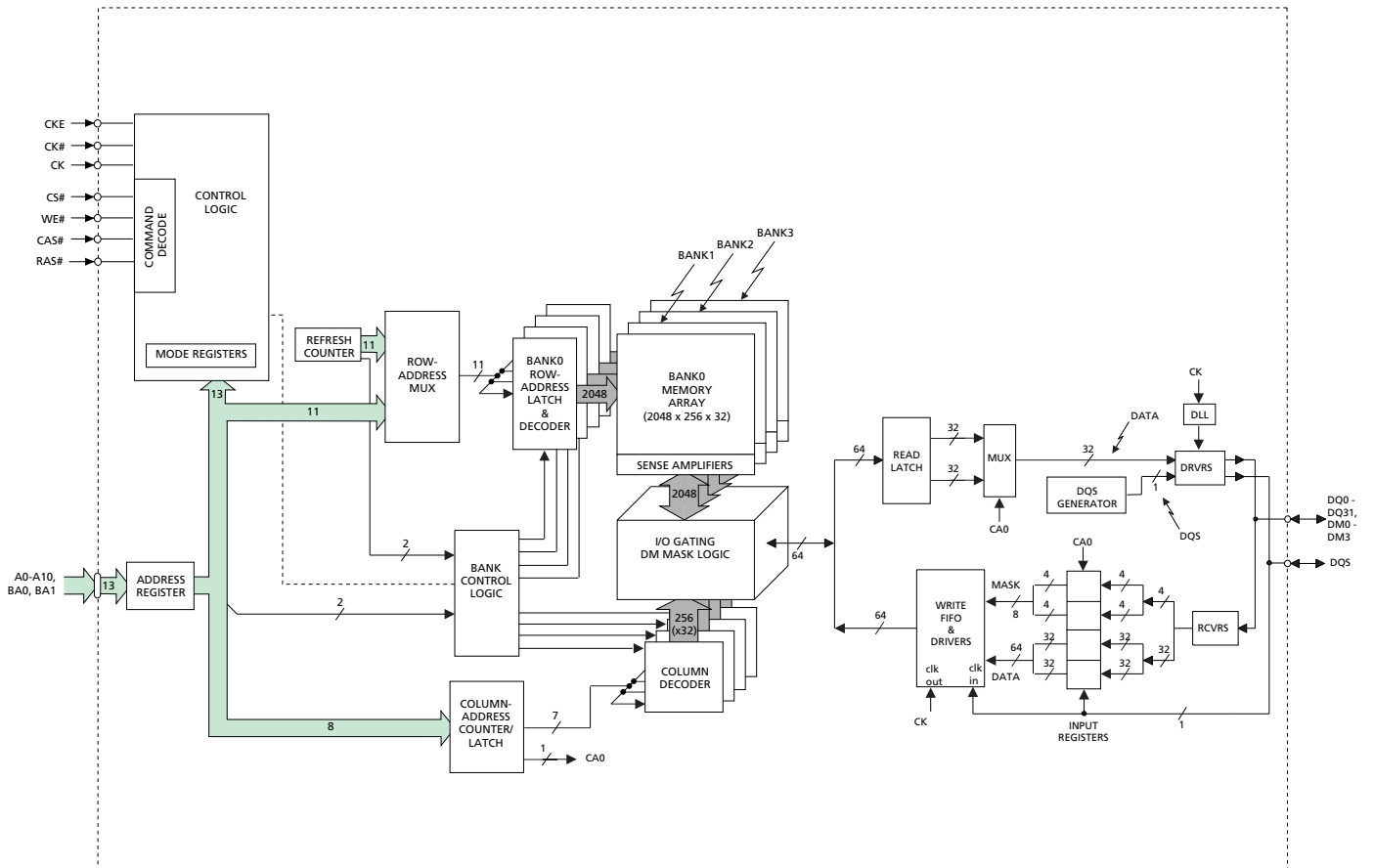

PIN DESCRIPTIONS

TQFP PIN NUMBERS	SYMBOL	TYPE	DESCRIPTION
55, 54	CK, CK#	Input	Clock: CK and CK# are differential clock inputs. All address and control input signals are sampled on the crossing of the positive edge of CK and negative edge of CK#. Output data (DQs and DQS) is referenced to the crossings of CK and CK#.
53	CKE	Input	Clock Enable: CKE HIGH activates and CKE LOW deactivates the internal clock, input buffers and output drivers. Taking CKE LOW provides PRECHARGE POWER-DOWN and SELF REFRESH operations (all banks idle), or ACTIVE POWER-DOWN (row ACTIVE in any bank). CKE is synchronous for POWER-DOWN entry and exit, and for SELF REFRESH entry. CKE is asynchronous for SELF REFRESH exit and for disabling the outputs. CKE must be maintained HIGH throughout read and write accesses. Input buffers (excluding CK, CK# and CKE) are disabled during POWER-DOWN. Input buffers (excluding CKE) are disabled during SELF REFRESH. CKE is an SSTL_2 input but will detect an LVCMOS LOW level after V _{DD} is applied.
28	CS#	Input	Chip Select: CS# enables (registered LOW) and disables (registered HIGH) the command decoder. All commands are masked when CS# is registered HIGH. CS# provides for external bank selection on systems with multiple banks. CS# is considered part of the command code.
27, 26, 25	RAS#, CAS#, WE#	Input	Command Inputs: RAS#, CAS#, and WE# (along with CS#) define the command being entered.
23, 56, 24, 57	DM0-DM3	Input	Input Data Mask: DM is an input mask signal for write data. Input data is masked when DM is sampled HIGH along with that input data during a WRITE access. DM is sampled on both edges of DQS. Although DM pins are input-only, the DM loading is designed to match that of DQ and DQS pins.
29, 30	BA0, BA1	Input	Bank Address Inputs: BA0 and BA1 define to which bank an ACTIVE, READ, WRITE, or PRECHARGE command is being applied.
31-34, 47-51, 45, 36	A0-A10	Input	Address Inputs: Provide the row address for ACTIVE commands, and the column address and auto precharge bit (A8) for READ/WRITE commands, to select one location out of the memory array in the respective bank. A8 sampled during a PRECHARGE command determines whether the PRECHARGE applies to one bank (A8 LOW, bank selected by BA0, BA1) or all banks (A8 HIGH). The address inputs also provide the op-code during a MODE REGISTER SET command. BA0 and BA1 define which mode register (mode register or extended mode register) is loaded during the LOAD MODE REGISTER command.
97, 98, 100, 1, 3, 4, 6, 7 60, 61, 63, 64, 68, 69, 71, 72 9, 10, 12, 13, 17, 18, 20, 21 74, 75, 77, 78, 80, 81, 83, 84	DQ0-31	I/O	Data Input/Output:

(continued on next page)

PIN DESCRIPTIONS (continued)

TQFP PIN NUMBERS	SYMBOL	TYPE	DESCRIPTION
94	DQS	I/O	Data Strobe: Output with read data, input with write data. DQS is edge-aligned with read data, centered in write data. It is used to capture data.
37-44 87-90	NC	–	No Connect: These pins should be left unconnected.
91	DNU	–	Do Not Use: Must float to minimize noise.
93	RFU		Reserved for Future Use
2, 8, 14, 22, 59, 67, 73, 79, 86, 95	V _{DDQ}	Supply	DQ Power Supply: Isolated on the die for improved noise immunity.
5, 11, 19, 62, 70, 76, 82, 92, 99	V _{SSQ}	Supply	DQ Ground. Isolated on the die for improved noise immunity.
15, 35, 65, 96	V _{DD}	Supply	Power Supply
16, 46, 66, 85	V _{SS}	Supply	Ground.
58	V _{REF}	Supply	SSTL_2 reference voltage.

RESERVED NC PINS¹

TQFP PIN NUMBERS	SYMBOL	TYPE	DESCRIPTION
37	A11	I	Address input for 128Mb and 256Mb devices.
44	A12	I	Address input for 256Mb devices. Not Finalized
52	NC (MCL)		No Connect: Not internally connected. Must Connect LOW (for compatibility with SGRAM devices).

NOTE: 1. NC pins not listed may also be reserved for other uses now or in the future. This table simply defines specific NC pins deemed to be of importance.

FUNCTIONAL DESCRIPTION

The 64Mb DDR SDRAM is a high-speed CMOS, dynamic random-access memory containing 67,108,864 bits. The 64Mb DDR SDRAM is internally configured as a quad-bank DRAM.

The 64Mb DDR SDRAM uses a double data rate architecture to achieve high-speed operation. The double data rate architecture is essentially a $2n$ -prefetch architecture, with an interface designed to transfer two data words per clock cycle at the I/O pins. A single read or write access for the 64Mb DDR SDRAM consists of a single $2n$ -bit wide, one-clock-cycle data transfer at the internal DRAM core and two corresponding n -bit wide, one-half-clock-cycle data transfers at the I/O pins.

Read and write accesses to the DDR SDRAM are burst oriented; accesses start at a selected location and continue for a programmed number of locations in a programmed sequence. Accesses begin with the registration of an ACTIVE command, which is then followed by a READ or WRITE command. The address bits registered coincident with the ACTIVE command are used to select the bank and row to be accessed (BA0, BA1 select the bank; A0–A10 select the row). The address bits registered coincident with the READ or WRITE command are used to select the starting column location for the burst access.

Prior to normal operation, the DDR SDRAM must be initialized. The following sections provide detailed information covering device initialization, register definition, command descriptions and device operation.

Initialization

DDR SDRAMs must be powered up and initialized in a predefined manner. Operational procedures other than those specified may result in undefined operation. Power must first be applied to V_{DD} and V_{DDQ} simultaneously, and then to V_{REF} (and to the system V_{TT}). V_{TT} must be applied after V_{DDQ} to avoid device latch-up, which may cause permanent damage to the device. V_{REF} can be applied any time after V_{DDQ} but is expected to be nominally coincident with V_{TT} . Except for CKE, inputs are not recognized as valid until after V_{REF} is applied. CKE is an SSTL_2 input but will detect an LVCMOS LOW level after V_{DD} is applied. Maintaining an LVCMOS LOW level on CKE during power-up is required to ensure that the DQ and DQS outputs will be in the High-Z state, where they will remain until driven in normal operation (by a read access). After all power supply and reference voltages are stable, and the clock is stable, the DDR SDRAM requires a 200 μ s delay prior to applying an executable command.

Once the 200 μ s delay has been satisfied, a DESELECT or NOP command should be applied, and CKE

should be brought HIGH. Following the NOP command, a PRECHARGE ALL command should be applied. Next a LOAD MODE REGISTER command should be issued for the extended mode register (BA1 LOW and BA0 HIGH) to enable the DLL, followed by another LOAD MODE REGISTER command to the mode register, BA0/BA1 must be LOW to reset the DLL and to program the operating parameters. Two-hundred clock cycles are required between the DLL reset and any READ command. A PRECHARGE ALL command should then be applied, placing the device in the all banks idle state.

Once in the idle state, two AUTO REFRESH cycles must be performed. (t_{RFC} must be satisfied.) Additionally, a LOAD MODE REGISTER command for the mode register with the reset DLL bit deactivated (i.e., to program operating parameters without resetting the DLL) is a requirement. Following these requirements, the DDR SDRAM is ready for normal operation.

Register Definition

MODE REGISTER

The mode register is used to define the specific mode of operation of the DDR SDRAM. This definition includes the selection of a burst length, a burst type, a CAS latency and an operating mode, as shown in Figure 1. The mode register is programmed via the MODE REGISTER SET command (with BA0 = 0 and BA1 = 0) and will retain the stored information until it is programmed again or the device loses power (except for bit A8, which is self-clearing).

Reprogramming the mode register will not alter the contents of the memory, provided it is performed correctly. The mode register must be loaded (reloaded) when all banks are idle and no bursts are in progress, and the controller must wait the specified time before initiating the subsequent operation. Violating either of these requirements will result in unspecified operation.

Mode register bits A0–A2 specify the burst length, A3 specifies the type of burst (sequential or interleaved), A4–A6 specify the CAS latency, and A7–A10 specify the operating mode.

Burst Length

Read and write accesses to the DDR SDRAM are burst oriented, with the burst length being programmable, as shown in Figure 1. The burst length determines the maximum number of column locations that can be accessed for a given READ or WRITE command. Burst lengths of 2, 4, or 8 locations are available for both sequential and interleaved modes. Full page burst is only available in sequential mode.

Reserved states should not be used, as unknown operation or incompatibility with future versions may result.

When a READ or WRITE command is issued, a block of columns equal to the burst length is effectively selected. All accesses for that burst take place within this block, meaning that the burst will wrap within the block if a boundary is reached. The block is uniquely selected by A1–A_i when the burst length is set to two, by A2–A_i when the burst length is set to four and by A3–A_i when the burst length is set to eight (where A_i is the most significant column address bit for a given configuration). The remaining (least significant) address bit(s) is (are) used to select the starting location within the block. The programmed burst length applies to both READ and WRITE bursts.

**Table 1
Burst Definition**

Burst Length	Starting Column Address	Order of Accesses Within a Burst	
		Type = Sequential	Type = Interleaved
2	A0		
	0	0-1	0-1
	1	1-0	1-0
4	A1 A0		
	0 0	0-1-2-3	0-1-2-3
	0 1	1-2-3-0	1-0-3-2
	1 0	2-3-0-1	2-3-0-1
	1 1	3-0-1-2	3-2-1-0
8	A2 A1 A0		
	0 0 0	0-1-2-3-4-5-6-7	0-1-2-3-4-5-6-7
	0 0 1	1-2-3-4-5-6-7-0	1-0-3-2-5-4-7-6
	0 1 0	2-3-4-5-6-7-0-1	2-3-0-1-6-7-4-5
	0 1 1	3-4-5-6-7-0-1-2	3-2-1-0-7-6-5-4
	1 0 0	4-5-6-7-0-1-2-3	4-5-6-7-0-1-2-3
	1 0 1	5-6-7-0-1-2-3-4	5-4-7-6-1-0-3-2
	1 1 0	6-7-0-1-2-3-4-5	6-7-4-5-2-3-0-1
	1 1 1	7-0-1-2-3-4-5-6	7-6-5-4-3-2-1-0
Full Page (256)	n = A0–A7, A0 = 0	C _n , C _{n+1} , C _{n+2} C _{n+3} , C _{n+4}C _{n-1} , C _n ...	Not supported
	n = A0–A7, A0 = 1	C _n , C _{n-1} , C _{n-2} C _{n-3} , C _{n-4}C _{n+1} , C _n ...	Not supported

- NOTE:**
1. For a burst length of two, A1–A7 select the block of two burst; A0 selects the starting column within the block.
 2. For a burst length of four, A2–A7 select the block of four burst; A0–A1 select the starting column within the block.
 3. For a burst length of eight, A3–A7 select the block of eight burst; A0–A2 select the starting column within the block.
 4. For a full-page burst, the full row is selected and A0–A7 select the starting column. A0 also selects the direction of the burst (incrementing if A0 = 0, decrementing if A0 = 1).
 5. Whenever a boundary of the block is reached within a given sequence above, the following access wraps within the block.

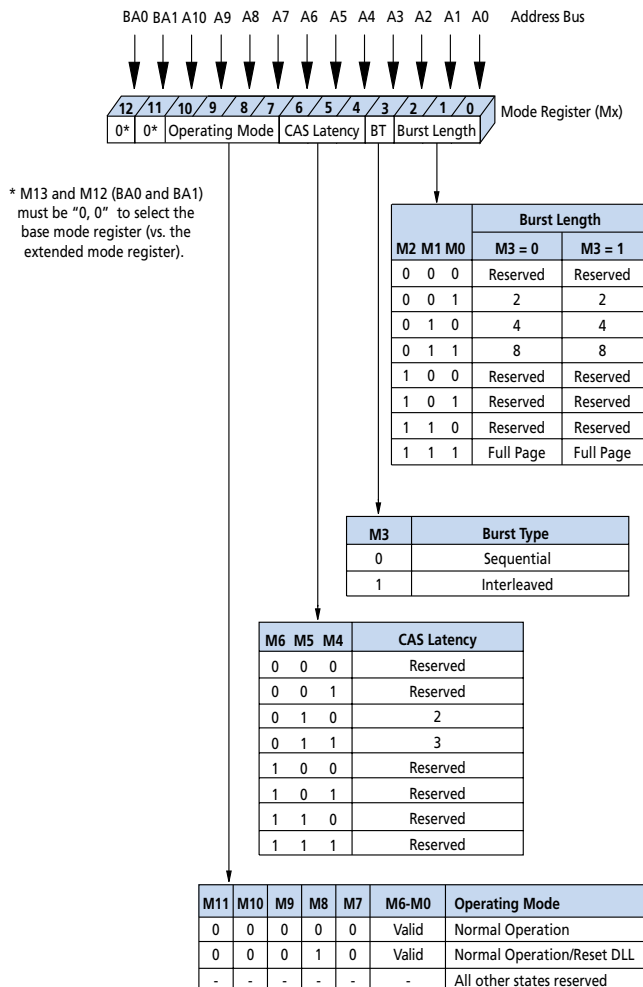

**Figure 1
Mode Register Definition**

Burst Type

Accesses within a given burst may be programmed to be either sequential or interleaved; this is referred to as the burst type and is selected via bit M3.

The ordering of accesses within a burst is determined by the burst length, the burst type and the starting column address, as shown in Table 1.

Read Latency

The READ latency is the delay, in clock cycles, between the registration of a READ command and the availability of the first bit of output data. The latency can be set to 2 or 3 clocks, as shown in Figure 2.

If a READ command is registered at clock edge n , and the latency is m clocks, the data will be available nominally coincident with clock edge $n + m$. Table 2 indicates the operating frequencies at which each CAS latency setting can be used.

Reserved states should not be used as unknown operation or incompatibility with future versions may result.

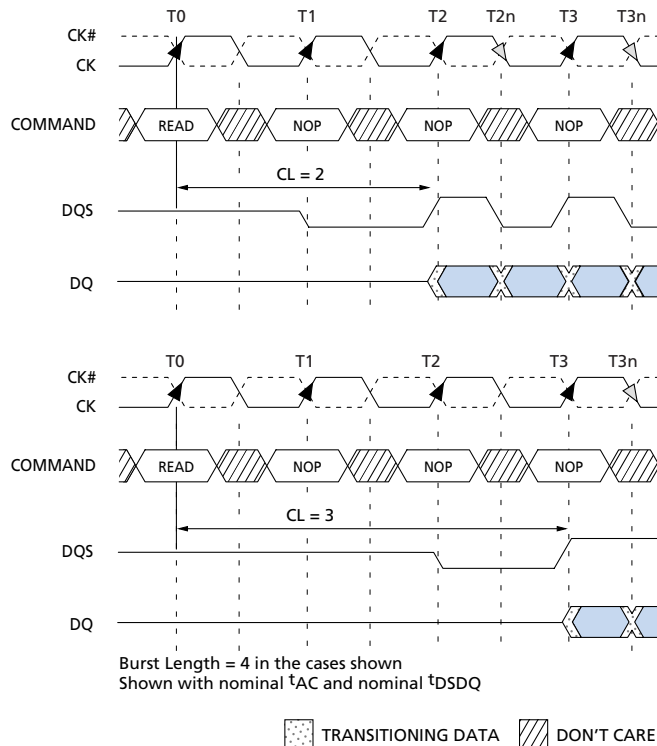

**Figure 2
CAS Latency**

**Table 2
CAS Latency**

SPEED	ALLOWABLE OPERATING FREQUENCY (MHz)	
	CL = 2	CL = 3
-5	$83 \leq f \leq 125$	$83 \leq f \leq 200$
-55	$83 \leq f \leq 100$	$83 \leq f \leq 183$
-6	$83 \leq f \leq 100$	$83 \leq f \leq 166$
-65	$83 \leq f \leq 100$	$83 \leq f \leq 150$

Operating Mode

The normal operating mode is selected by issuing a MODE REGISTER SET command with bits A7-A10 each set to zero, and bits A0-A6 set to the desired values. A DLL reset is initiated by issuing a MODE REGISTER SET command with bits A7, A9 - A10 each set to zero, bit A8 set to one, and bits A0-A6 set to the desired values. Although not required by the Micron device, JEDEC specifications recommend when a LOAD MODE REGISTER command is issued to reset the DLL, it should always be followed by a LOAD MODE REGISTER command to select normal operating mode.

All other combinations of values for A7-A10 are reserved for future use and/or test modes. Test modes and reserved states should not be used because unknown operation or incompatibility with future versions may result.

EXTENDED MODE REGISTER

The extended mode register controls functions beyond those controlled by the mode register; these additional functions are DLL enable/disable. These functions are controlled via the bits shown in Figure 3. The extended mode register is programmed via the LOAD MODE REGISTER command to the mode register (with BA0 = 1 and BA1 = 0) and will retain the stored information until it is programmed again or the device loses power. Although not required by the Micron device, the enabling of the DLL should always be followed by a LOAD MODE REGISTER command to the mode register (BA0/BA1 both LOW) to reset the DLL.

The extended mode register must be loaded when all banks are idle and no bursts are in progress, and the controller must wait the specified time before initiating any subsequent operation. Violating either of these requirements could result in unspecified operation.

Output Drive Strength

The reduced drive strength for all outputs are specified to be SSTL_2. The x32 supports an option for impedance matched drive. This option is intended for the support of the lighter load and/or point-to-point environments. The selection of the impedance drive strength will alter the DQs and DQSs from SSTL_2, Class I drive strength to a reduced drive strength, which is approximately 30 percent of the SSTL_2 Class II, drive strength.

DLL Enable/Disable

The DLL must be enabled for normal operation. DLL enable is required during power-up initialization and upon returning to normal operation after having disabled the DLL for the purpose of debug or evaluation. (When the device exits self refresh mode, the DLL is enabled automatically.) Any time the DLL is enabled, 200 clock cycles must occur before a READ command can be issued.

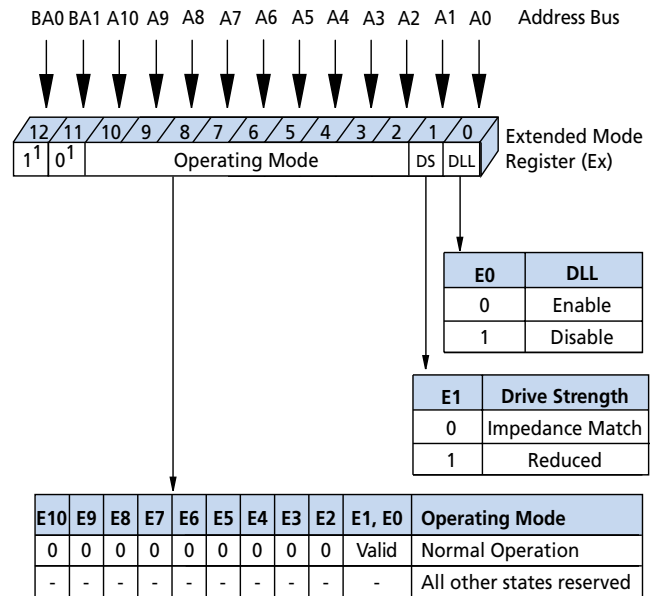

NOTE: 1. E13 and E12 (BA0 and BA1) must be 1, 0 to select the Extended Mode Register (vs. the base Mode Register).

Figure 3
Extended Mode Register Definition

Commands

Truth Table 1 provides a quick reference of available commands. This is followed by a verbal description of each command. Two additional Truth Tables

appear following the Operation section; these tables provide current state/next state information.

TRUTH TABLE 1 – COMMANDS

(Note: 1)

NAME (FUNCTION)	CS#	RAS#	CAS#	WE#	ADDR	NOTES
DESELECT (NOP)	H	X	X	X	X	9
NO OPERATION (NOP)	L	H	H	H	X	9
ACTIVE (Select bank and activate row)	L	L	H	H	Bank/Row	3
READ (Select bank and column, and start READ burst)	L	H	L	H	Bank/Col	4
WRITE (Select bank and column, and start WRITE burst)	L	H	L	L	Bank/Col	4
BURST TERMINATE	L	H	H	L	X	8
PRECHARGE (Deactivate row in bank or banks)	L	L	H	L	Code	5
AUTO REFRESH or SELF REFRESH (Enter self refresh mode)	L	L	L	H	X	6, 7
LOAD MODE REGISTER	L	L	L	L	Op-Code	2

TRUTH TABLE 1A – DM OPERATION

NAME (FUNCTION)	DM	DQs	NOTES
Write Enable	L	Valid	10
Write Inhibit	H	X	10

- NOTE:**
1. CKE is HIGH for all commands shown except SELF REFRESH.
 2. BA0-BA1 select either the mode register or the extended mode register (BA0 = 0, BA1 = 0 select the mode register; BA0 = 1, BA1 = 0 select extended mode register; other combinations of BA0-BA1 are reserved). A0-A11 provide the op-code to be written to the selected mode register.
 3. BA0-BA1 provide bank address and A0-A10 provide row address.
 4. BA0-BA1 provide bank address; A0-A7 provide column address; A8 HIGH enables the auto precharge feature (nonpersistent), and A8 LOW disables the auto precharge feature.
 5. A8 LOW: BA0-BA1 determine which bank is precharged.
A8 HIGH: all banks are precharged and BA0-BA1 are "Don't Care."
 6. This command is AUTO REFRESH if CKE is HIGH, SELF REFRESH if CKE is LOW.
 7. Internal refresh counter controls row addressing; all inputs and I/Os are "Don't Care" except for CKE during self refresh.
 8. Applies only to read bursts with auto precharge disabled; this command is undefined (and should not be used) for READ bursts with auto precharge enabled and for WRITE bursts.
 9. Deselect and NOP are functionally interchangeable.
 10. Used to mask write data; provided coincident with the corresponding data.

DESELECT

The Deselect function (CS# HIGH) prevents new commands from being executed by the DDR SDRAM. The DDR SDRAM is effectively deselected. Operations already in progress are not affected.

NO OPERATION (NOP)

The NO OPERATION (NOP) command is used to instruct the selected DDR SDRAM to perform a NOP (CS# LOW). This prevents unwanted commands from being registered during idle or wait states. Operations already in progress are not affected.

LOAD MODE REGISTER

The mode registers are loaded via inputs A0-A10. See mode register descriptions in the Register Definition section. The LOAD MODE REGISTER command can only be issued when all banks are idle, and a subsequent executable command cannot be issued until ^tMRD is met.

ACTIVE

The ACTIVE command is used to open (or activate) a row in a particular bank for a subsequent access. The value on the BA0, BA1 inputs selects the bank, and the address provided on inputs A0-A10 selects the row. This row remains active (or open) for accesses until a PRECHARGE command is issued to that bank. A PRECHARGE command must be issued before opening a different row in the same bank.

READ

The READ command is used to initiate a burst read access to an active row. The value on the BA0, BA1 inputs selects the bank, and the address provided on inputs A0-A7 selects the starting column location. The value on input A8 determines whether or not auto precharge is used. If auto precharge is selected, the row being accessed will be precharged at the end of the READ burst; if auto precharge is not selected, the row will remain open for subsequent accesses.

WRITE

The WRITE command is used to initiate a burst write access to an active row. The value on the BA0, BA1 inputs selects the bank, and the address provided on inputs A0-A7 selects the starting column location. The value on input A8 determines whether or not auto precharge is used. If auto precharge is selected, the row being accessed will be precharged at the end of the WRITE burst; if auto precharge is not selected, the row will remain open for subsequent accesses. Input data appearing on the DQs is written to the memory array

subject to the DM input logic level appearing coincident with the data. If a given DM signal is registered LOW, the corresponding data will be written to memory; if the DM signal is registered HIGH, the corresponding data inputs will be ignored, and a WRITE will not be executed to that byte/column location.

PRECHARGE

The PRECHARGE command is used to deactivate the open row in a particular bank or the open row in all banks. The bank(s) will be available for a subsequent row access a specified time (^tRP) after the PRECHARGE command is issued. Input A8 determines whether one or all banks are to be precharged, and in the case where only one bank is to be precharged, inputs BA0, BA1 select the bank. Otherwise BA0, BA1 are treated as "Don't Care." Once a bank has been precharged, it is in the idle state and must be activated prior to any READ or WRITE commands being issued to that bank. A PRECHARGE command will be treated as a NOP if there is no open row in that bank (idle state), or if the previously open row is already in the process of precharging.

AUTO PRECHARGE

Auto precharge is a feature which performs the same individual-bank precharge function described above, but without requiring an explicit command. This is accomplished by using A8 to enable auto precharge in conjunction with a specific READ or WRITE command. A precharge of the bank/row that is addressed with the READ or WRITE command is automatically performed upon completion of the READ or WRITE burst. Auto precharge is nonpersistent in that it is either enabled or disabled for each individual READ or WRITE command.

Auto precharge ensures that the precharge is initiated at the earliest valid stage within a burst. This "earliest valid stage" is determined as if an explicit PRECHARGE command was issued at the earliest possible time, as described for each burst type in the Operation section of this data sheet. The user must not issue another command to the same bank until the precharge time (^tRP) is completed.

BURST TERMINATE

The BURST TERMINATE command is used to truncate READ bursts (with auto precharge disabled). The most recently registered READ command prior to the BURST TERMINATE command will be truncated, as shown in the Operation section of this data sheet. The BURST TERMINATE does not precharge the row.

AUTO REFRESH

AUTO REFRESH is used during normal operation of the DDR SDRAM and is analogous to CAS#-BEFORE-RAS# (CBR) REFRESH in FPM/EDO DRAMs. This command is nonpersistent, so it must be issued each time a refresh is required.

The addressing is generated by the internal refresh controller. This makes the address bits a “Don’t Care” during an AUTO REFRESH command. The 64Mb x32 DDR SDRAM requires AUTO REFRESH cycles at an average interval of 7.8 μ s (maximum).

To allow for improved efficiency in scheduling and switching between tasks, some flexibility in the absolute refresh interval is provided. A maximum of eight AUTO REFRESH commands can be posted to any given DDR SDRAM, meaning that the maximum absolute interval between any AUTO REFRESH command and the next AUTO REFRESH command is $9 \times 7.8\mu\text{s}$ (70.2 μ s). This maximum absolute interval is to allow future support for DLL updates internal to the DDR SDRAM to be restricted to AUTO REFRESH cycles, without allowing excessive drift in t^{AC} between updates.

SELF REFRESH

The SELF REFRESH command can be used to retain data in the DDR SDRAM, even if the rest of the system is powered down. When in the self refresh mode, the DDR SDRAM retains data without external clocking. The SELF REFRESH command is initiated like an AUTO REFRESH command except CKE is disabled (LOW). The DLL is automatically disabled upon entering SELF REFRESH and is automatically enabled upon exiting SELF REFRESH (200 clock cycles must then occur before a READ command can be issued). Input signals except CKE are “Don’t Care” during SELF REFRESH.

The procedure for exiting self refresh requires a sequence of commands. First, CK must be stable prior to CKE going back HIGH. Once CKE is HIGH, the DDR SDRAM must have NOP commands issued for t^{XSNR} because time is required for the completion of any internal refresh in progress. A simple algorithm for meeting both refresh and DLL requirements is to apply NOPs for 200 clock cycles before applying any other command.

Operations

BANK/ROW ACTIVATION

Before any READ or WRITE commands can be issued to a bank within the DDR SDRAM, a row in that bank must be “opened.” This is accomplished via the ACTIVE command, which selects both the bank and the row to be activated, as shown in Figure 4.

After a row is opened with an ACTIVE command, a READ or WRITE command may be issued to that row, subject to the t_{RCD} specification. t_{RCD} (MIN) should be divided by the clock period and rounded up to the next whole number to determine the earliest clock edge after the ACTIVE command on which a READ or WRITE command can be entered. For example, a t_{RCD} specification of 20ns with a 125 MHz clock (8ns period) results in 2.5 clocks rounded to 3. This is reflected in Figure 5, which covers any case where $2 < t_{RCD} \text{ (MIN)} / t_{CK} \leq 3$. (Figure 5 also shows the same case for t_{RCD} ; the same procedure is used to convert other specification limits from time units to clock cycles).

A subsequent ACTIVE command to a different row in the same bank can only be issued after the previous active row has been “closed” (precharged). The minimum time interval between successive ACTIVE commands to the same bank is defined by t_{RC} .

A subsequent ACTIVE command to another bank can be issued while the first bank is being accessed, which results in a reduction of total row-access overhead. The minimum time interval between successive ACTIVE commands to different banks is defined by t_{RRD} .

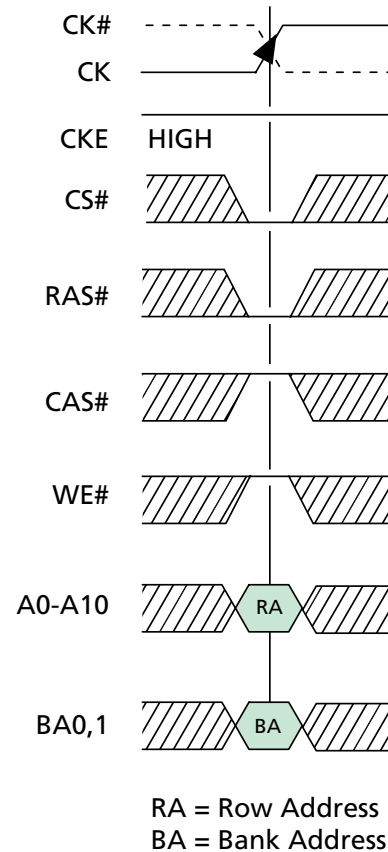
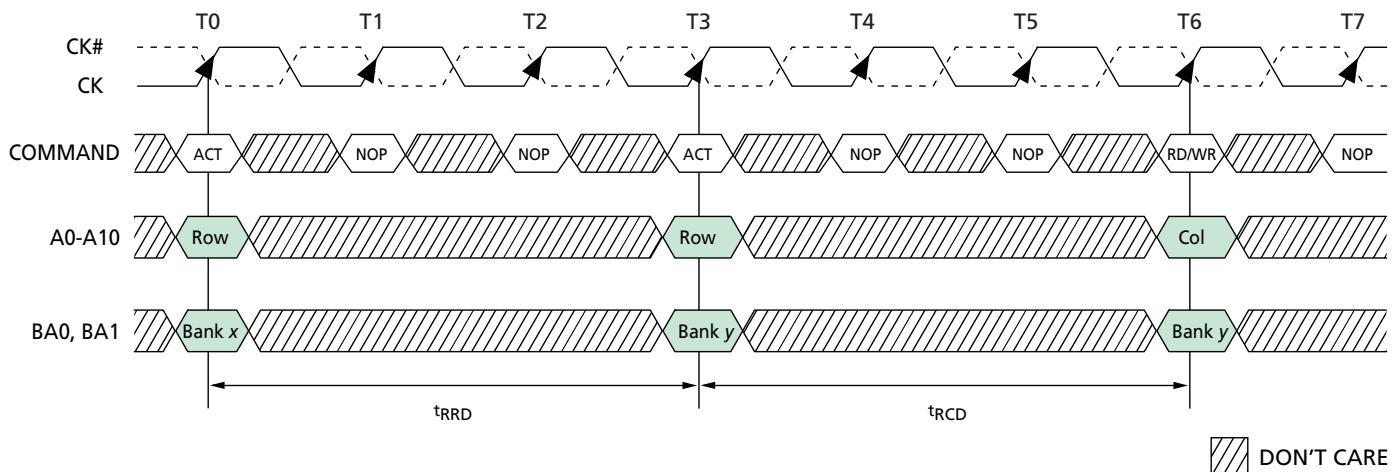

Figure 4
Activating a Specific Row in a Specific Bank



READS

READ bursts are initiated with a READ command, as shown in Figure 6.

The starting column and bank addresses are provided with the READ command and auto precharge is either enabled or disabled for that burst access. If auto precharge is enabled, the row being accessed is precharged at the completion of the burst. For the generic READ commands used in the following illustrations, auto precharge is disabled.

During READ bursts, the valid data-out element from the starting column address will be available following the CAS latency after the READ command. Each subsequent data-out element will be valid nominally at the next positive or negative clock edge (i.e., at the next crossing of CK and CK#). Figure 7 shows general timing for each possible CAS latency setting. DQS is driven by the DDR SDRAM along with output data. The initial LOW state on DQS is known as the read preamble; the LOW state coincident with the last data-out element is known as the read postamble.

Upon completion of a burst, assuming no other commands have been initiated, the DQs will go High-Z. A detailed explanation of ^tDQSQ (valid data-out skew), ^tQH (data-out window hold), the valid data window are depicted in Figure 27. A detailed explanation of ^tDQSCK (DQS transition skew to CK) and ^tAC (data-out transition skew to CK) is depicted in Figure 28.

Data from any READ burst may be concatenated with or truncated with data from a subsequent READ command. In either case, a continuous flow of data can be maintained. The first data element from the new burst follows either the last element of a completed burst or the last desired data element of a longer burst which is being truncated. The new READ command should be issued *x* cycles after the first READ command, where *x* equals the number of desired data element pairs (pairs are required by the 2*n*-prefetch architecture). This is shown in Figure 8. A READ command can be initiated on any clock cycle following a previous READ command. Nonconsecutive read data is shown for illustration in Figure 9. Full-speed random read accesses within a page (or pages) can be performed as shown in Figure 10.

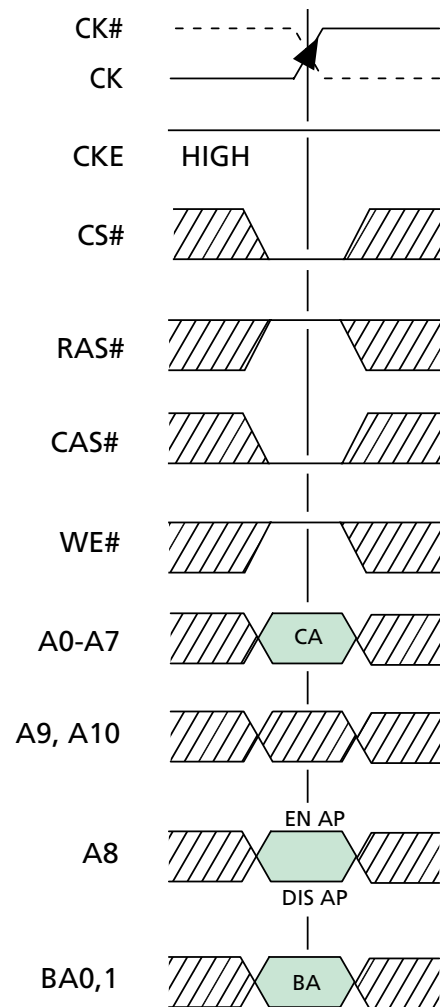

CA = Column Address
 BA = Bank Address
 EN AP = Enable Auto Precharge
 DIS AP = Disable Auto Precharge

DON'T CARE

**Figure 6
READ Command**

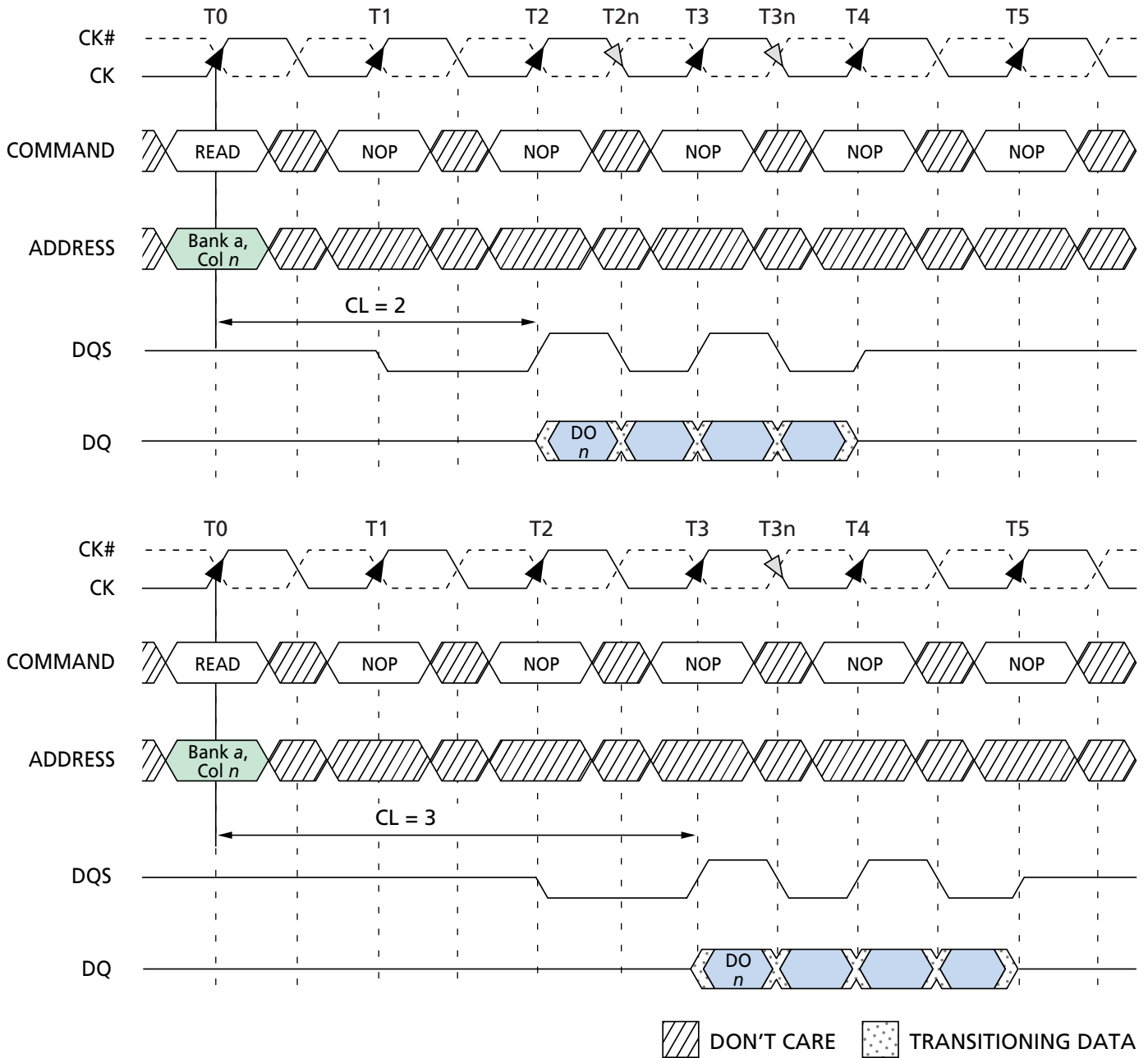

- NOTE:**
1. $DO\ n$ = data-out from column n .
 2. Burst length = 4.
 3. Three subsequent elements of data-out appear in the programmed order following $DO\ n$.
 4. Shown with nominal t_{AC} , t_{DQSK} , and t_{DQSQ} .

**Figure 7
READ Burst**

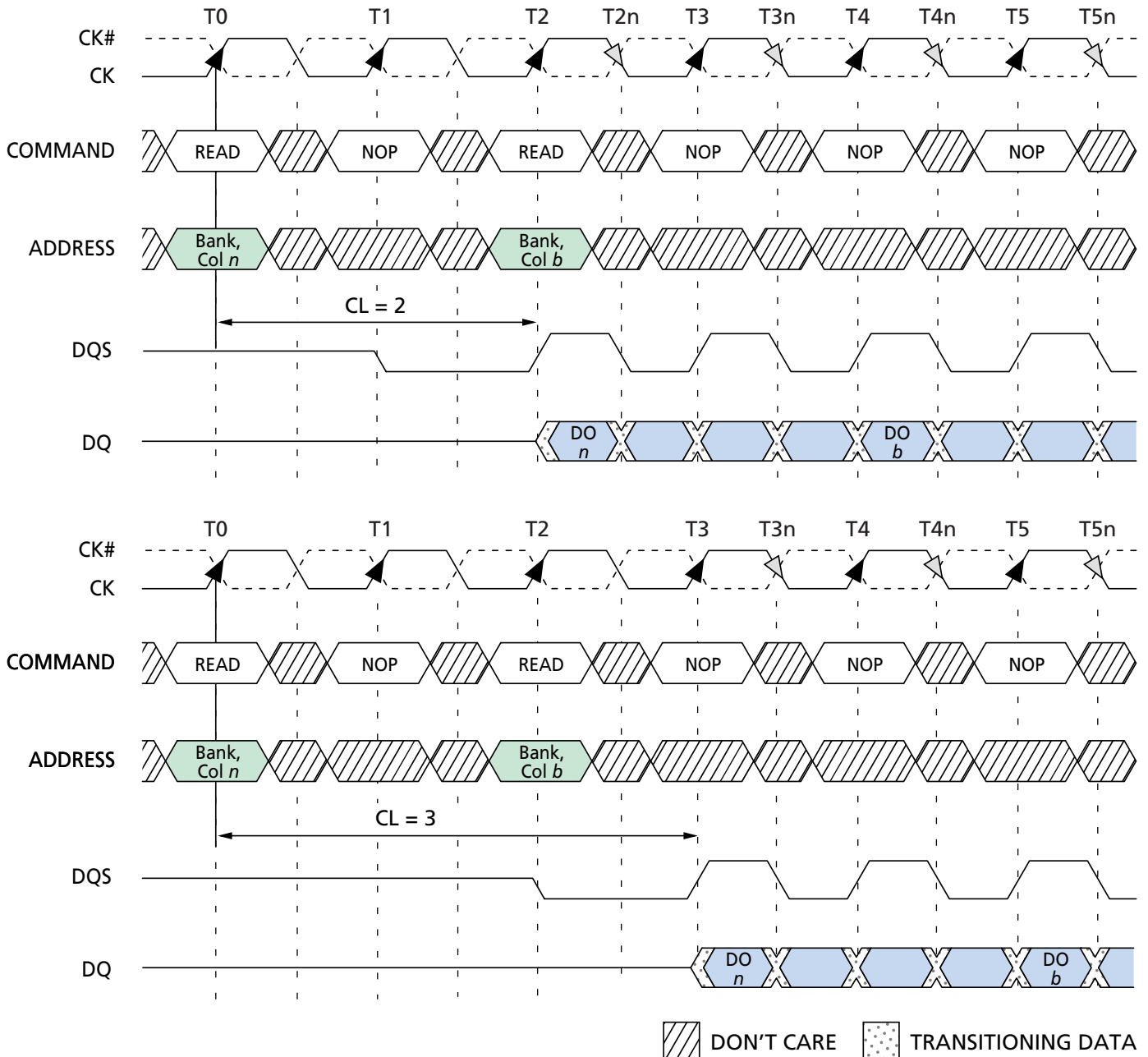

- NOTE:**
1. DO *n* (or *b*) = data-out from column *n* (or column *b*).
 2. Burst length = 4 or 8 (if 4, the bursts are concatenated; if 8, the second burst interrupts the first).
 3. Three subsequent elements of data-out appear in the programmed order following DO *n*.
 4. Three (or seven) subsequent elements of data-out appear in the programmed order following DO *b*.
 5. Shown with nominal t_{AC} , $t_{DQ\overline{SCK}}$, and $t_{DQ\overline{SQ}}$.
 6. Example applies only when READ commands are issued to same device.

**Figure 8
Consecutive READ Bursts**

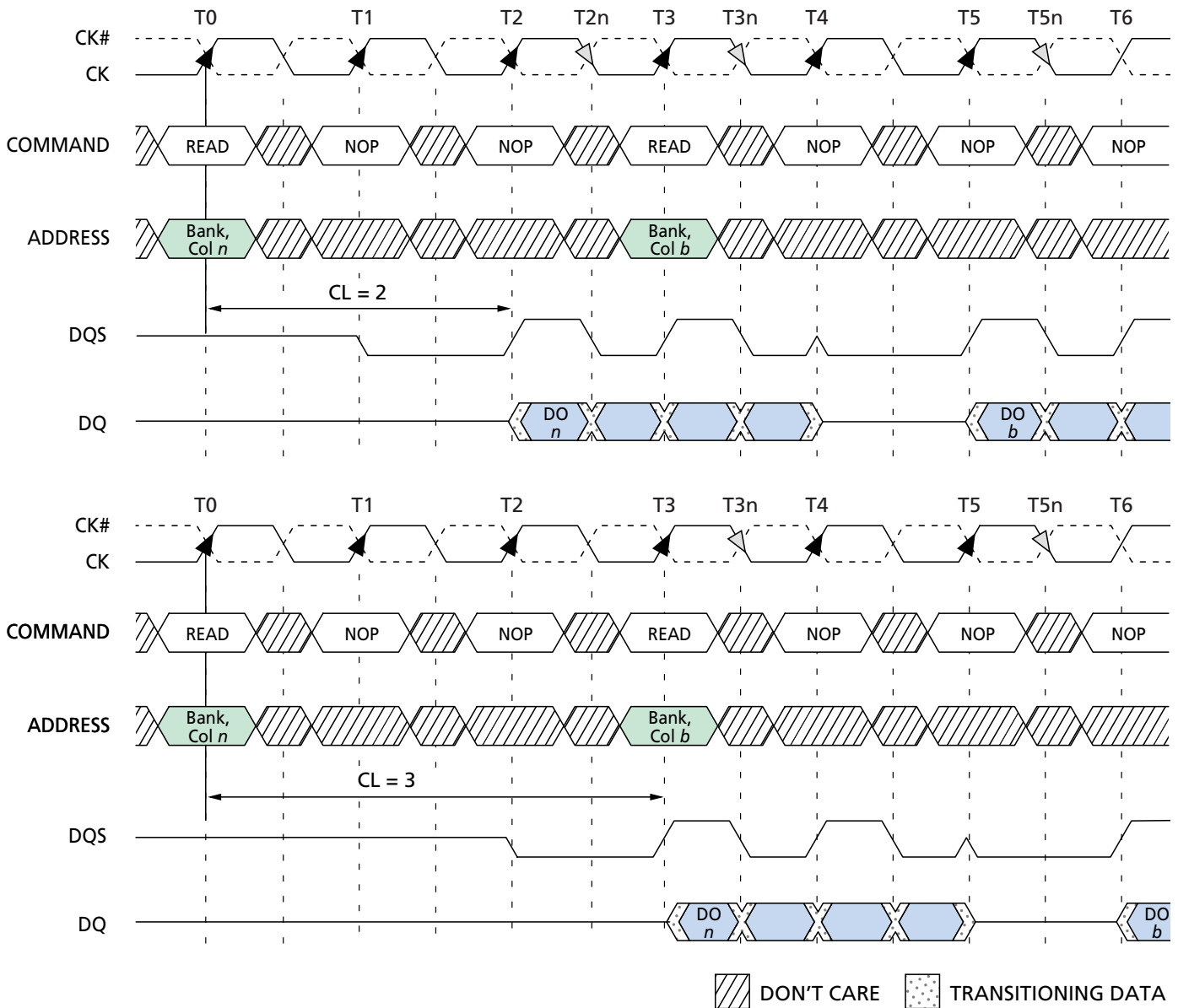

- NOTE:**
1. DO *n* (or *b*) = data-out from column *n* (or column *b*).
 2. Burst length = 4 or 8 (if 4, the bursts are concatenated; if 8, the second burst interrupts the first).
 3. Three subsequent elements of data-out appear in the programmed order following DO *n*.
 4. Three (or seven) subsequent elements of data-out appear in the programmed order following DO *b*.
 5. Shown with nominal t_{AC} , t_{DQSCK} , and t_{DQSQ} .
 6. Example applies when READ commands are issued to different devices or nonconsecutive READs.

Figure 9
Nonconsecutive READ Bursts

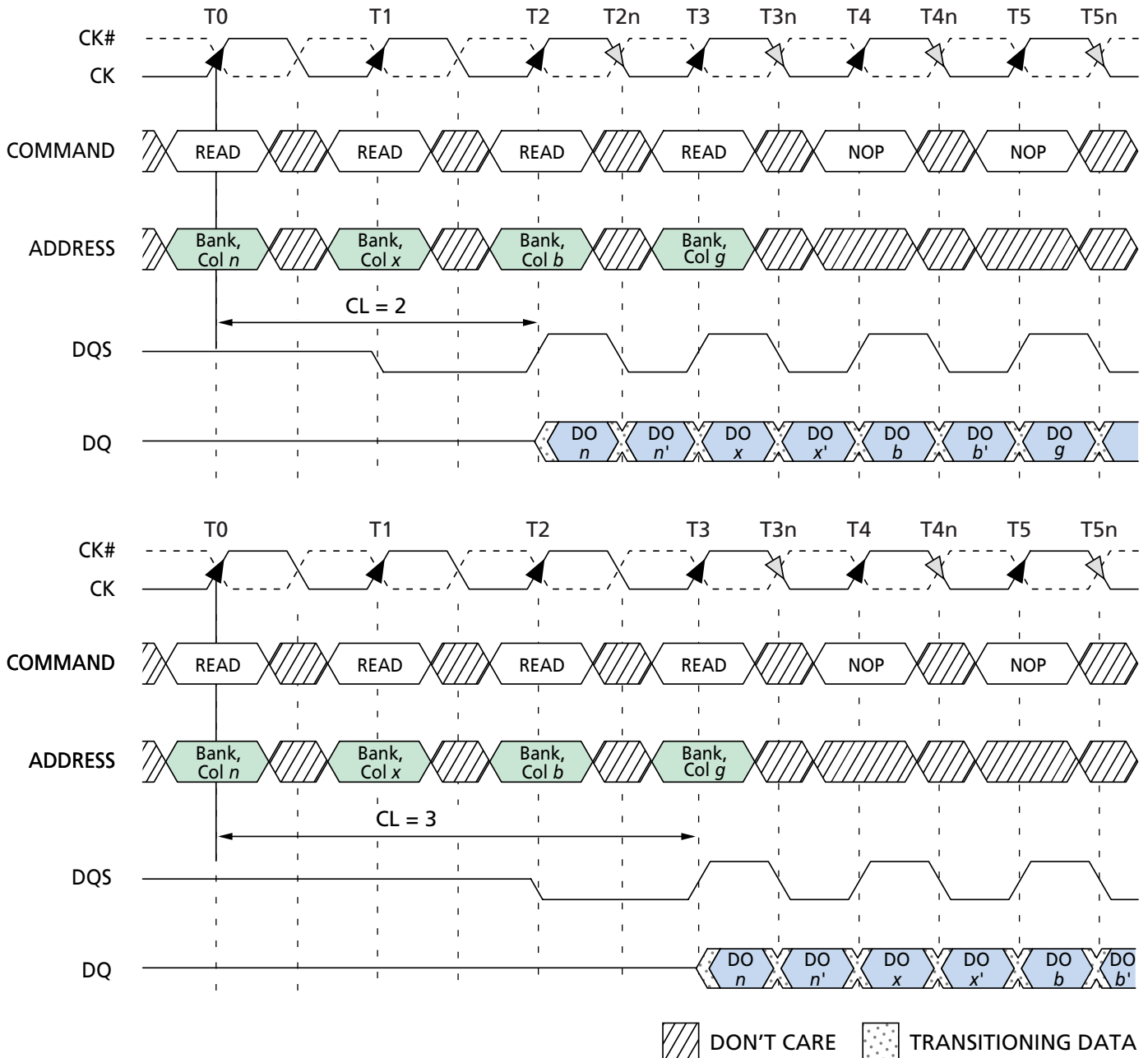

- NOTE:**
1. DO *n* (or *x* or *b* or *g*) = data-out from column *n* (or column *x* or column *b* or column *g*).
 2. Burst length = 2 or 4 or 8 (if 4 or 8, the following burst interrupts the previous).
 3. *n'* or *x'* or *b'* or *g'* indicates the next data-out following DO *n* or DO *x* or DO *b* or DO *g*, respectively.
 4. READs are to an active row in any bank.
 5. Shown with nominal t_{AC} , t_{DQSK} , and t_{DQSQ} .

**Figure 10
Random READ Accesses**

READs (continued)

Data from any READ burst may be truncated with a BURST TERMINATE command, as shown in Figure 11. The BURST TERMINATE latency is equal to the READ (CAS) latency, i.e., the BURST TERMINATE command should be issued x cycles after the READ command, where x equals the number of desired data element pairs (pairs are required by the $2n$ -prefetch architecture).

Data from any READ burst must be completed or truncated before a subsequent WRITE command can be issued. If truncation is necessary, the BURST TERMINATE command must be used, as shown in Figure 12. The $t^{\text{DQSS}}(\text{MIN})$ case is shown; the $t^{\text{DQSS}}(\text{MAX})$ case has a longer bus idle time. ($t^{\text{DQSS}}[\text{MIN}]$ and

$t^{\text{DQSS}}[\text{MAX}]$ are defined in the section on WRITES.)

A READ burst may be followed by, or truncated with, a PRECHARGE command to the same bank provided that auto precharge was not activated. The PRECHARGE command should be issued x cycles after the READ command, where x equals the number of desired data element pairs (pairs are required by the $2n$ -prefetch architecture). This is shown in Figure 13. Following the PRECHARGE command, a subsequent command to the same bank cannot be issued until t^{RP} is met. Note that part of the row precharge time is hidden during the access of the last data elements.

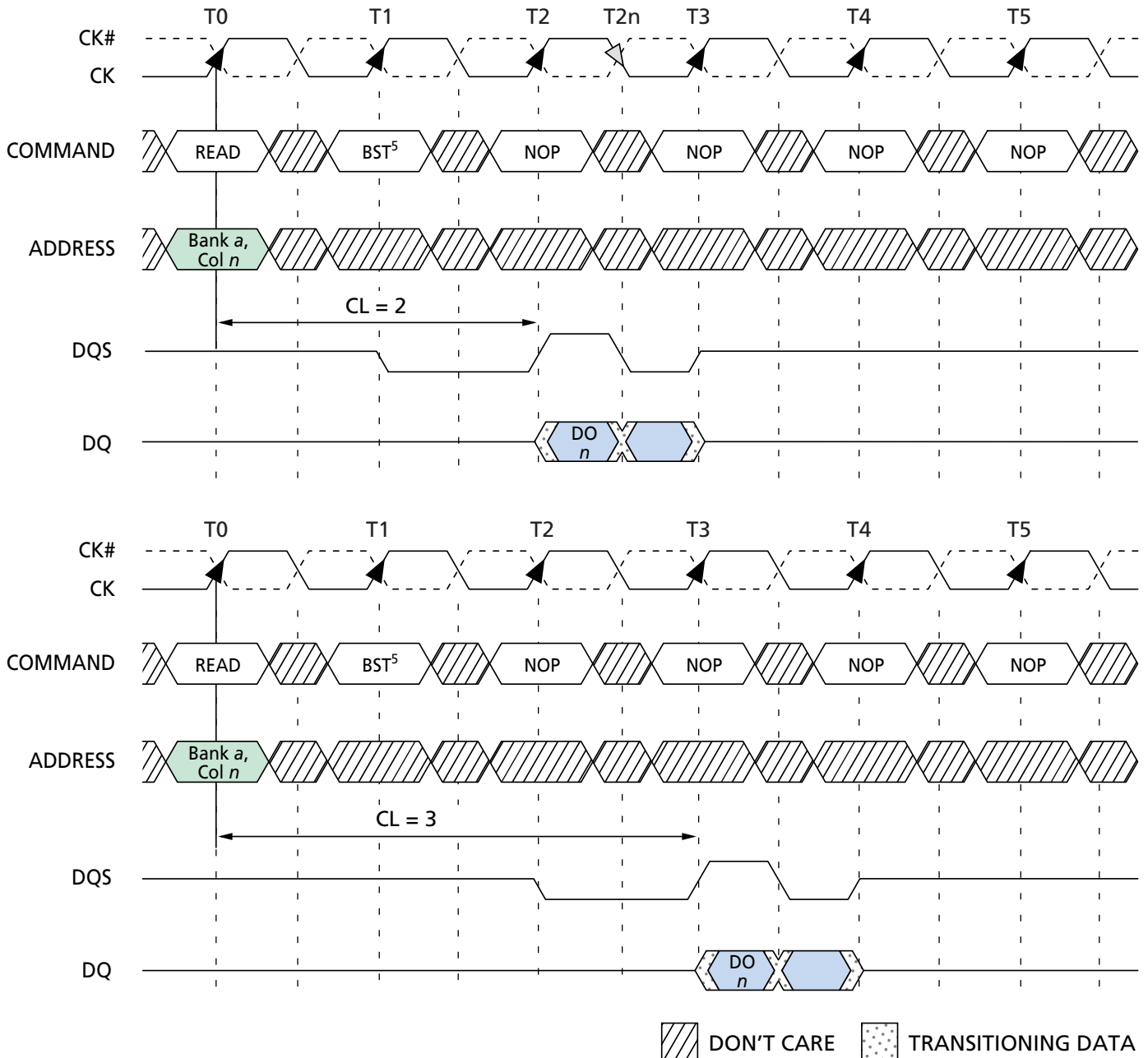

- NOTE:**
1. DO n = data-out from column n .
 2. Burst length = 4.
 3. Subsequent element of data-out appears in the programmed order following DO n .
 4. Shown with nominal t_{AC} , t_{DQSCK} , and t_{DQSQ} .
 5. BST = BURST TERMINATE command.

Figure 11
Terminating a READ Burst

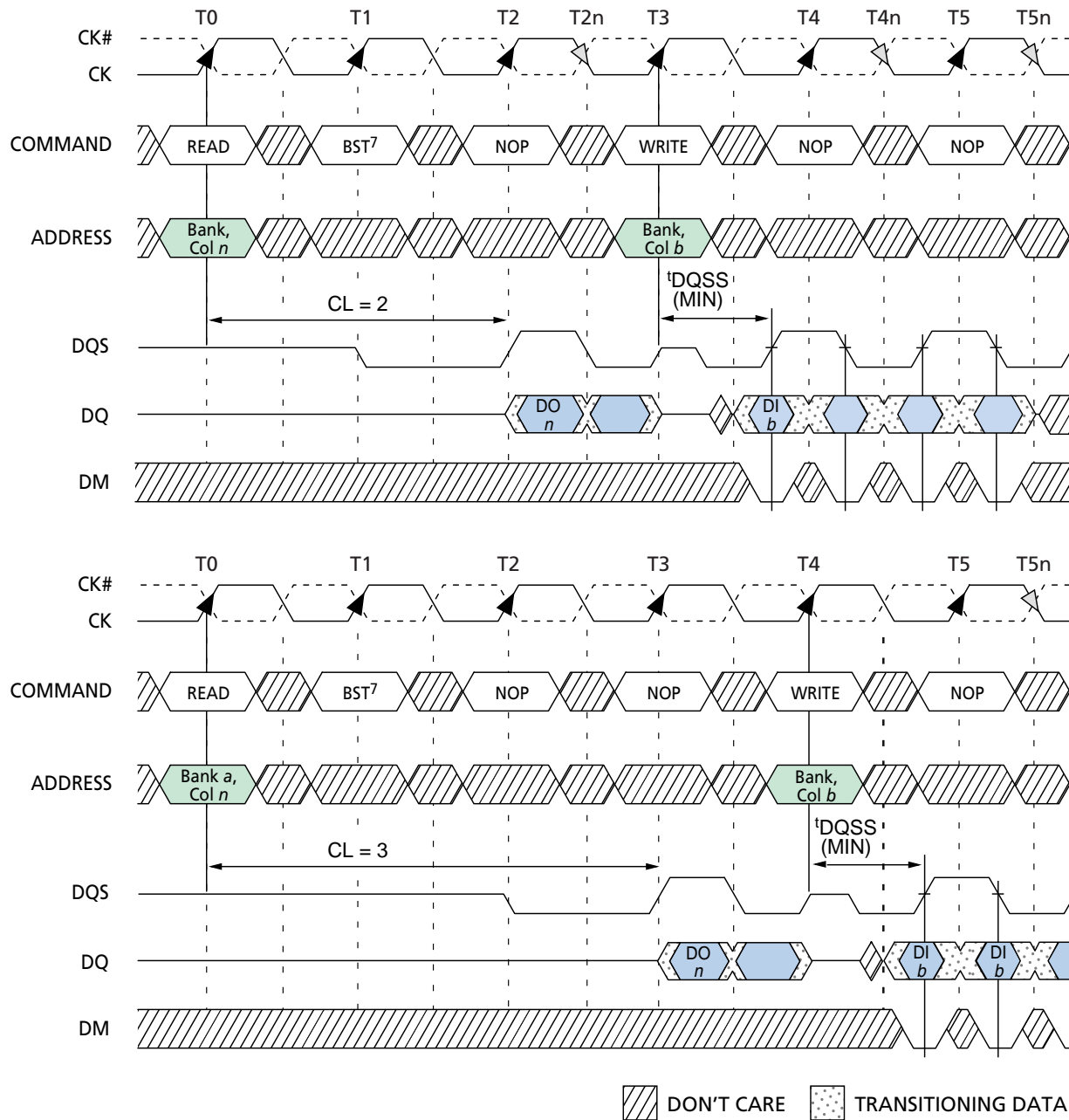

- NOTE:**
1. DO_n = data-out from column n .
 2. DI_b = data-in from column b .
 3. Burst length = 4 in the cases shown (applies for bursts of 8 and full page as well; if the burst length is 2, the BST command shown can be NOP).
 4. One subsequent element of data-out appears in the programmed order following DO_n .
 5. Data-in elements are applied following DI_b in the programmed order.
 6. Shown with nominal t_{AC} , t_{DQSK} , and t_{DQSQ} .
 7. BST = BURST TERMINATE command.

**Figure 12
READ to WRITE**

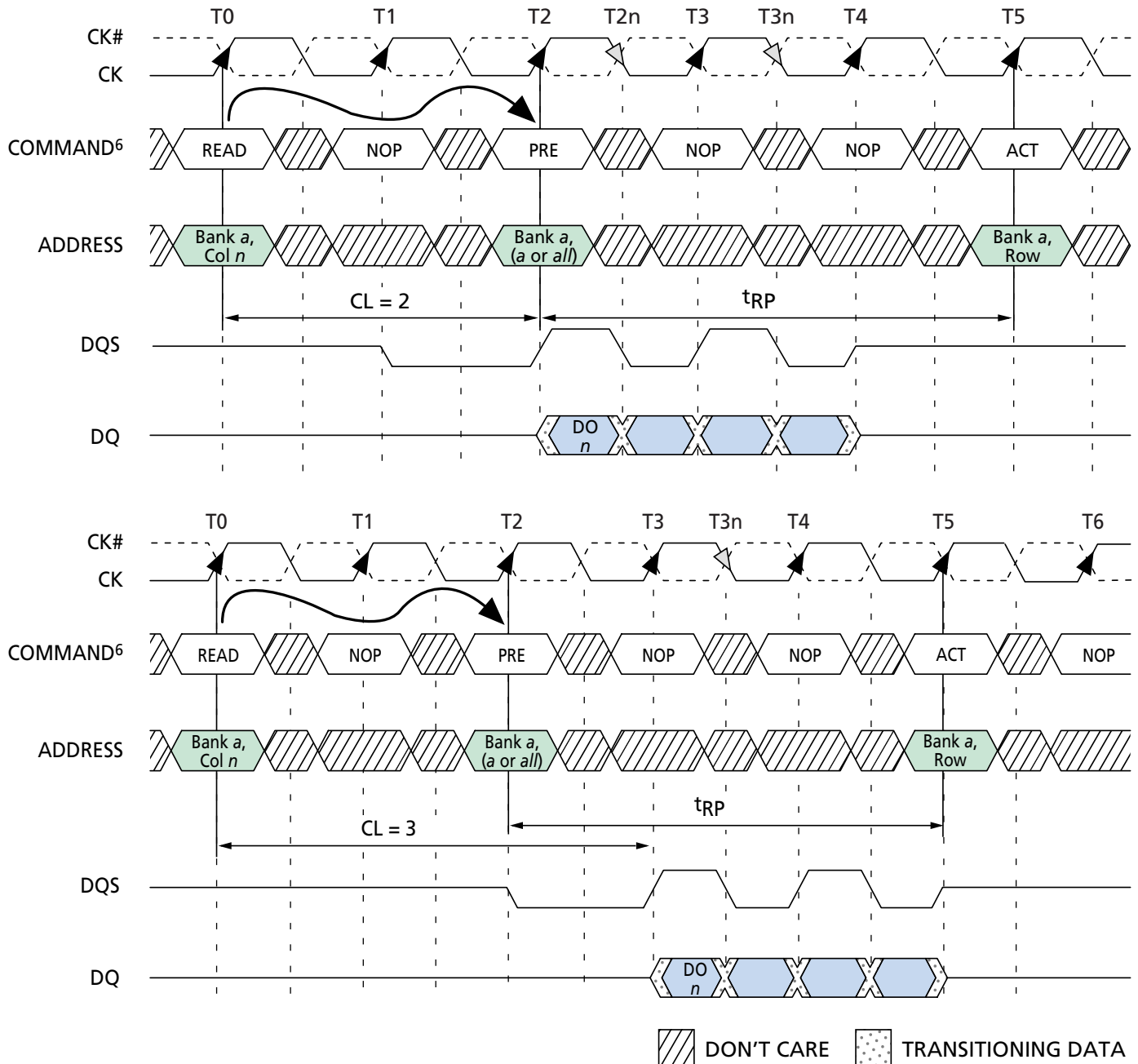

- NOTE:**
1. DO n = data-out from column n .
 2. Burst length = 4, or an interrupted burst of 8 or full page.
 3. Three subsequent elements of data-out appear in the programmed order following DO n .
 4. Shown with nominal t_{AC} , t_{DQSCK} , and t_{DQSQ} .
 5. READ to PRECHARGE equals two clocks, which allows two data pairs of data-out.
 6. PRE = PRECHARGE command; ACT = ACTIVE command.

Figure 13
READ to PRECHARGE

WRITES

WRITE bursts are initiated with a WRITE command, as shown in Figure 14.

The starting column and bank addresses are provided with the WRITE command, and auto precharge is either enabled or disabled for that access. If auto precharge is enabled, the row being accessed is precharged at the completion of the burst. For the generic WRITE commands used in the following illustrations, auto precharge is disabled.

During WRITE bursts, the first valid data-in element will be registered on the first rising edge of DQS following the WRITE command, and subsequent data elements will be registered on successive edges of DQS. The LOW state on DQS between the WRITE command and the first rising edge is known as the write preamble; the LOW state on DQS following the last data-in element is known as the write postamble.

The time between the WRITE command and the first corresponding rising edge of DQS (t_{DQSS}) is specified with a relatively wide range (from 75 percent to 125 percent of one clock cycle). All of the WRITE diagrams show the nominal case, and where the two extreme cases (i.e., t_{DQSS} [MIN] and t_{DQSS} [MAX]) might not be intuitive, they have also been included. Figure 15 shows the nominal case and the extremes of t_{DQSS} for a burst of 4. Upon completion of a burst, assuming no other commands have been initiated, the DQs will remain High-Z and any additional input data will be ignored.

Data for any WRITE burst may be concatenated with or truncated with a subsequent WRITE command. In either case, a continuous flow of input data can be maintained. The new WRITE command can be issued on any positive edge of clock following the previous WRITE command. The first data element from the new burst is applied after either the last element of a completed burst or the last desired data element of a longer burst which is being truncated. The new WRITE command should be issued x cycles after the first WRITE command, where x equals the number of desired data element pairs (pairs are required by the $2n$ -prefetch architecture).

Figure 16 shows concatenated bursts of 4. An example of nonconsecutive WRITES is shown in Figure 17. Full-speed random write accesses within a page or pages can be performed as shown in Figure 18.

Data for any WRITE burst may be followed by a subsequent READ command. To follow a WRITE without truncating the WRITE burst, t_{WTR} should be met as shown in Figure 19.

Data for any WRITE burst may be truncated by a subsequent READ command, as shown in Figure 20. Note that only the data-in pairs that are registered

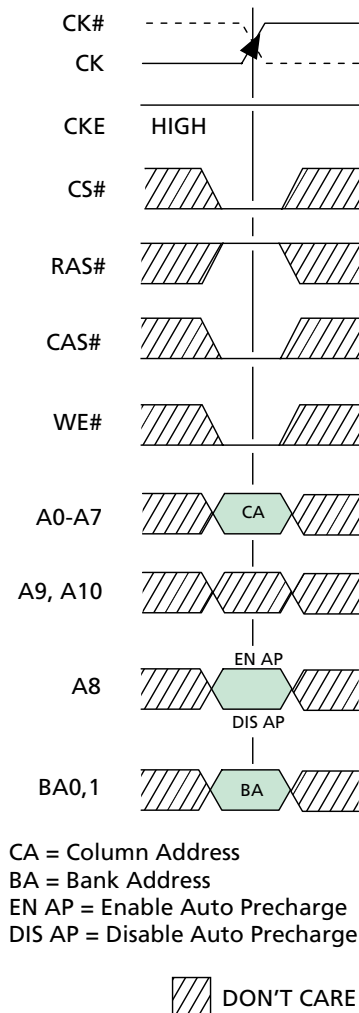
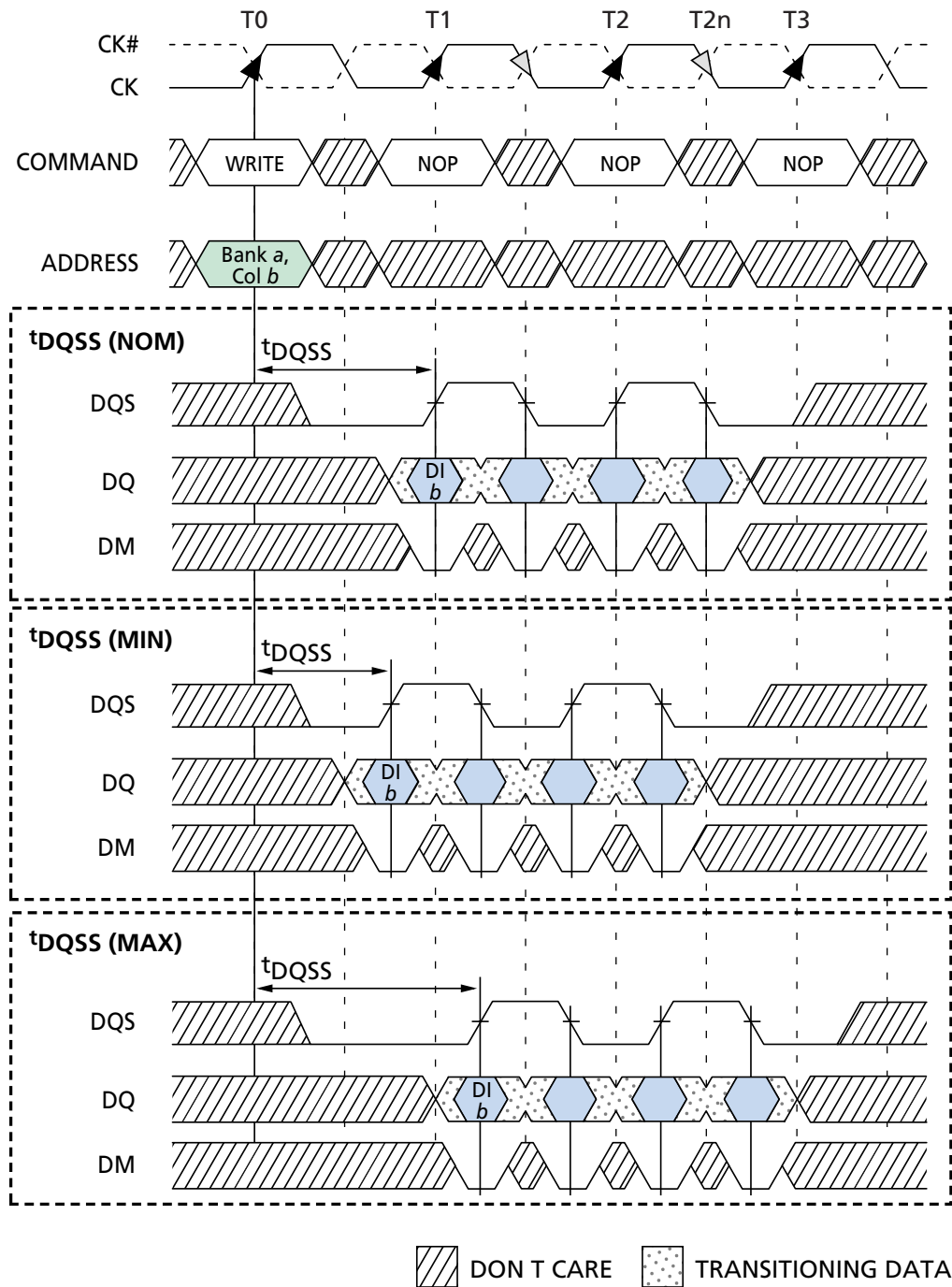

**Figure 14
WRITE Command**

prior to the t_{WTR} period are written to the internal array, and any subsequent data-in should be masked with DM as shown in Figure 21.

Data for any WRITE burst may be followed by a subsequent PRECHARGE command. To follow a WRITE without truncating the WRITE burst, t_{WR} should be met as shown in Figure 22.

Data for any WRITE burst may be truncated by a subsequent PRECHARGE command, as shown in Figures 23 and 24. Note that only the data-in pairs that are registered prior to the t_{WR} period are written to the internal array, and any subsequent data-in should be masked with DM as shown in Figures 23 and 24. After the PRECHARGE command, a subsequent command to the same bank cannot be issued until t_{RP} is met.



- NOTE:**
1. DI *b* = data-in for column *b*.
 2. Three subsequent elements of data-in are applied in the programmed order following DI *b*.
 3. An uninterrupted burst of 4 is shown.
 4. A8 is LOW with the WRITE command (auto precharge is disabled).

**Figure 15
WRITE Burst**

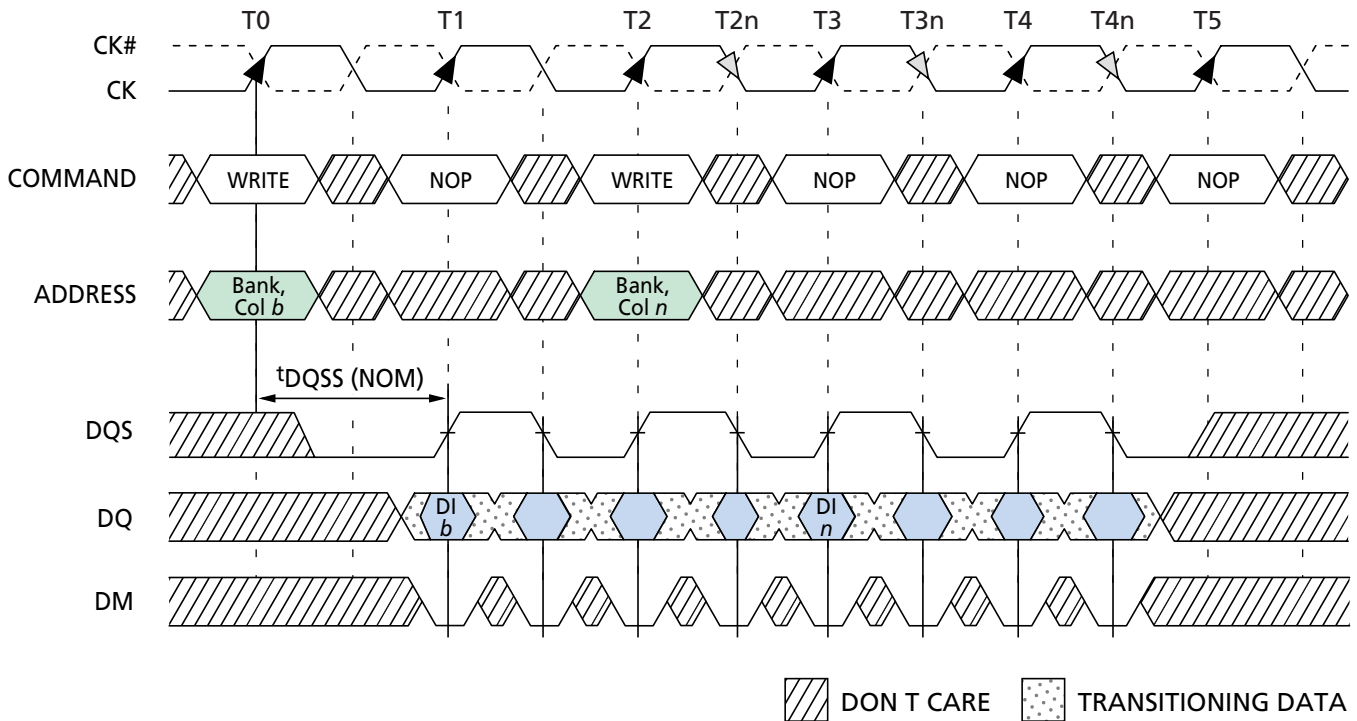

- NOTE:**
1. DI *b*, etc. = data-in for column *b*, etc.
 2. Three subsequent elements of data-in are applied in the programmed order following DI *b*.
 3. Three subsequent elements of data-in are applied in the programmed order following DI *n*.
 4. An uninterrupted burst of 4 is shown.
 5. Each WRITE command may be to any bank.

**Figure 16
Consecutive WRITE to WRITE**

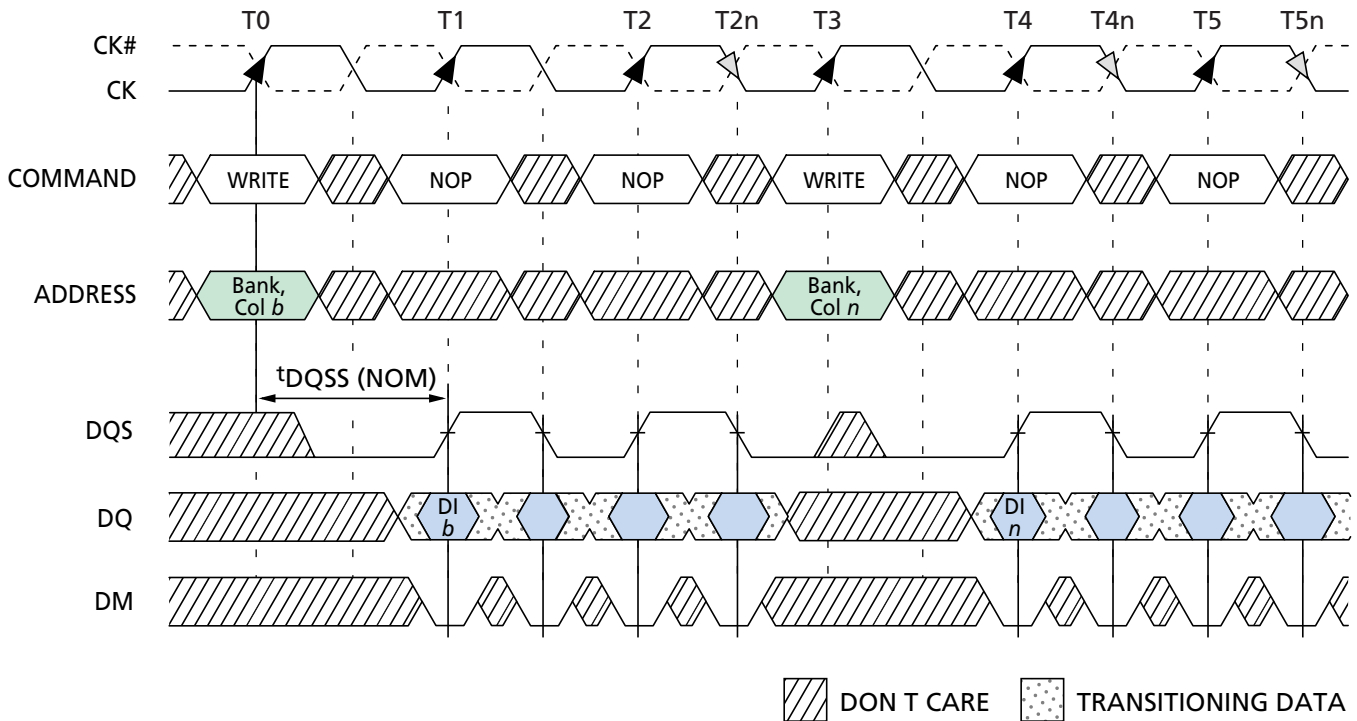

- NOTE:**
1. DI *b*, etc. = data-in for column *b*, etc.
 2. Three subsequent elements of data-in are applied in the programmed order following DI *b*.
 3. Three subsequent elements of data-in are applied in the programmed order following DI *n*.
 4. An uninterrupted burst of 4 is shown.
 5. Each WRITE command may be to any bank.

Figure 17
Nonconsecutive WRITE to WRITE

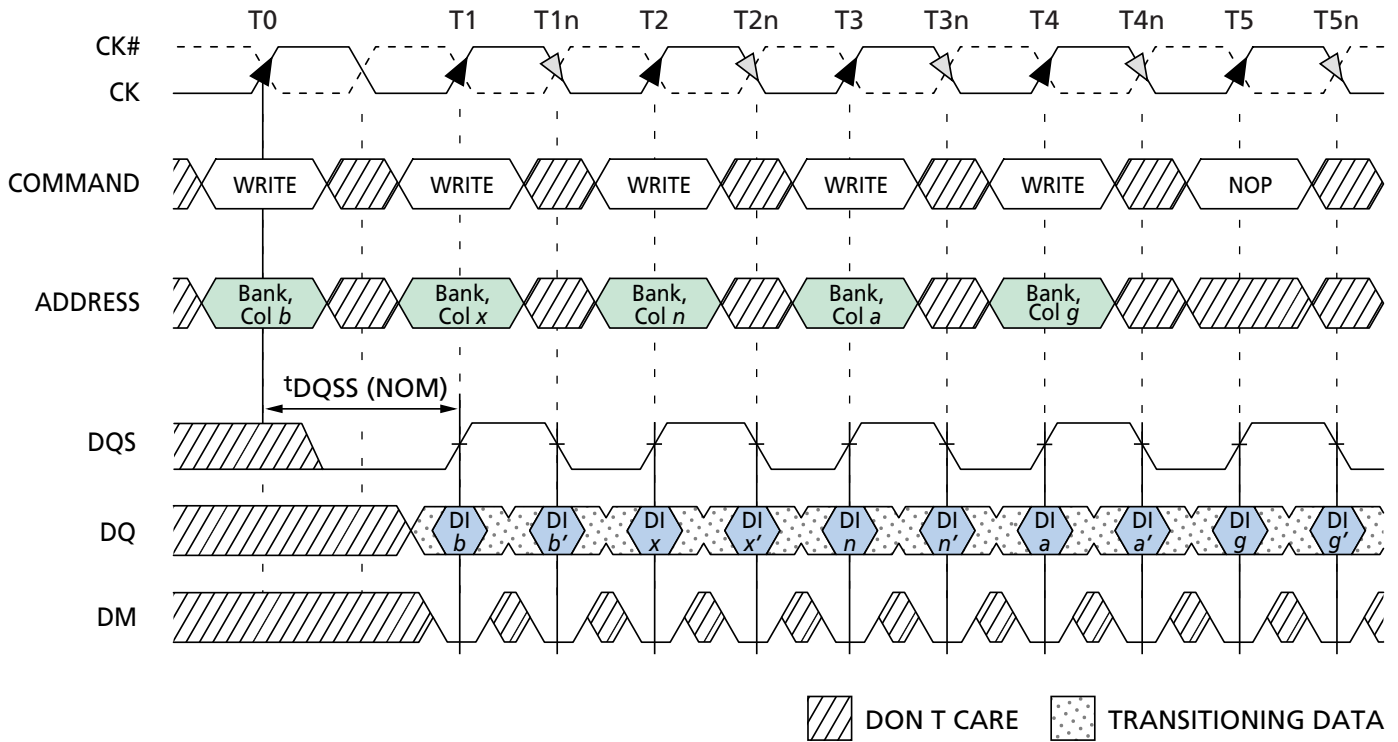

- NOTE:**
1. DI *b*, etc. = data-in for column *b*, etc.
 2. *b'*, etc. = the next data-in following DI *b*, etc., according to the programmed burst order.
 3. Programmed burst length = 2, 4, or 8 in cases shown.
 4. Each WRITE command may be to any bank.

**Figure 18
Random WRITE Cycles**

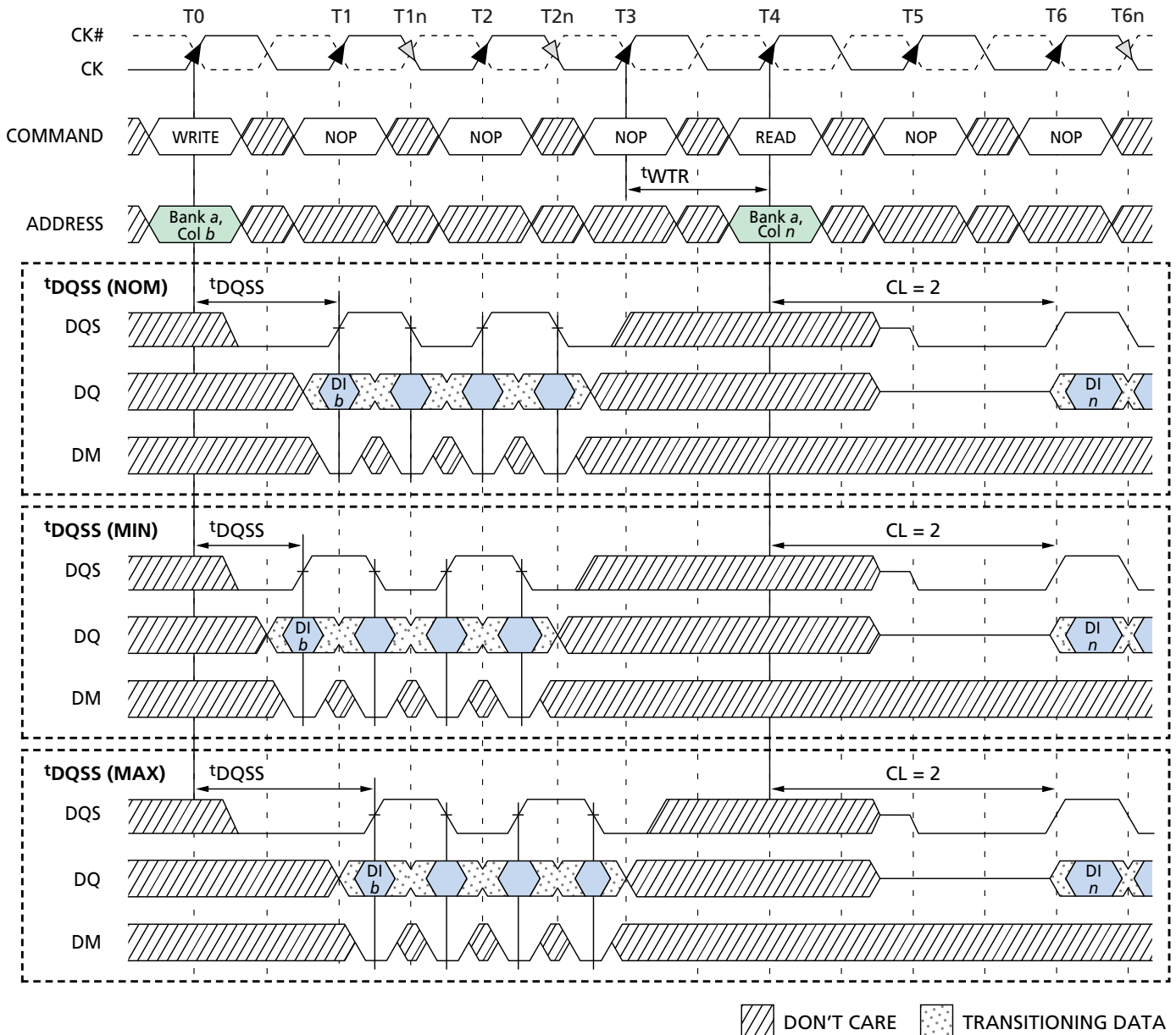

- NOTE:**
1. DI *b* = data-in for column *b*.
 2. Three subsequent elements of data-in are applied in the programmed order following DI *b*.
 3. An uninterrupted burst of 4 is shown.
 4. t_{WTR} is referenced from the first positive CK edge after the last data-in pair.
 5. The READ and WRITE commands are to the same bank. However, the READ and WRITE commands may be to different devices, in which case t_{WTR} is not required and the READ command could be applied earlier.
 6. A8 is LOW with the WRITE command (auto precharge is disabled).

Figure 19
WRITE to READ – Uninterrupting

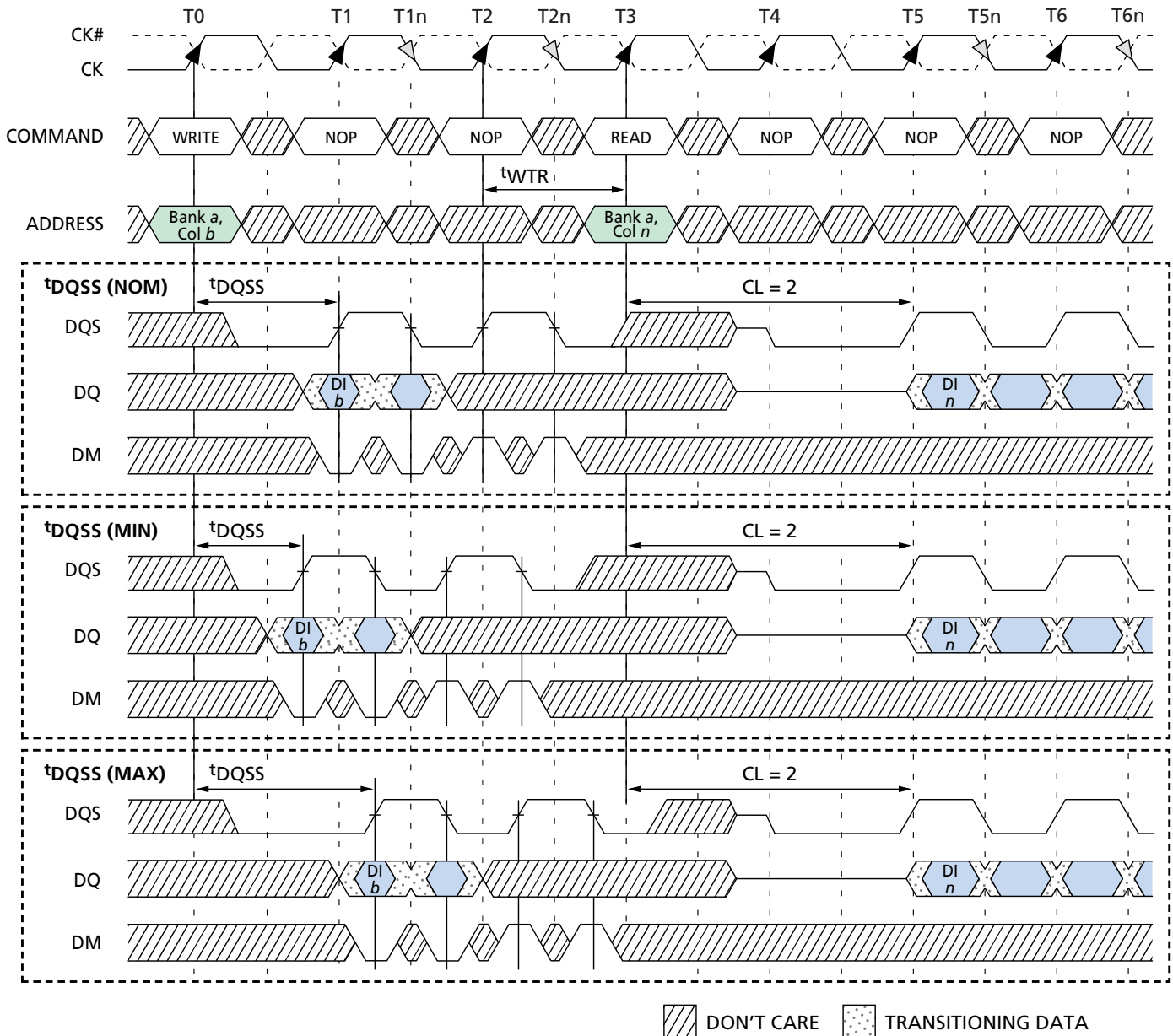

- NOTE:**
1. DI *b* = data-in for column *b*.
 2. An interrupted burst of 4 or 8 is shown; two data elements are written.
 3. One subsequent element of data-in is applied in the programmed order following DI *b*.
 4. t_{WTR} is referenced from the first positive CK edge after the last data-in pair.
 5. A8 is LOW with the WRITE command (auto precharge is disabled).
 6. DQS is required at T2 and T2n (nominal case) to register DM.
 7. If the burst of 8 was used, DM would not be required at T3-T4n because the READ command would mask the last two data elements.

**Figure 20
WRITE to READ – Interrupting**

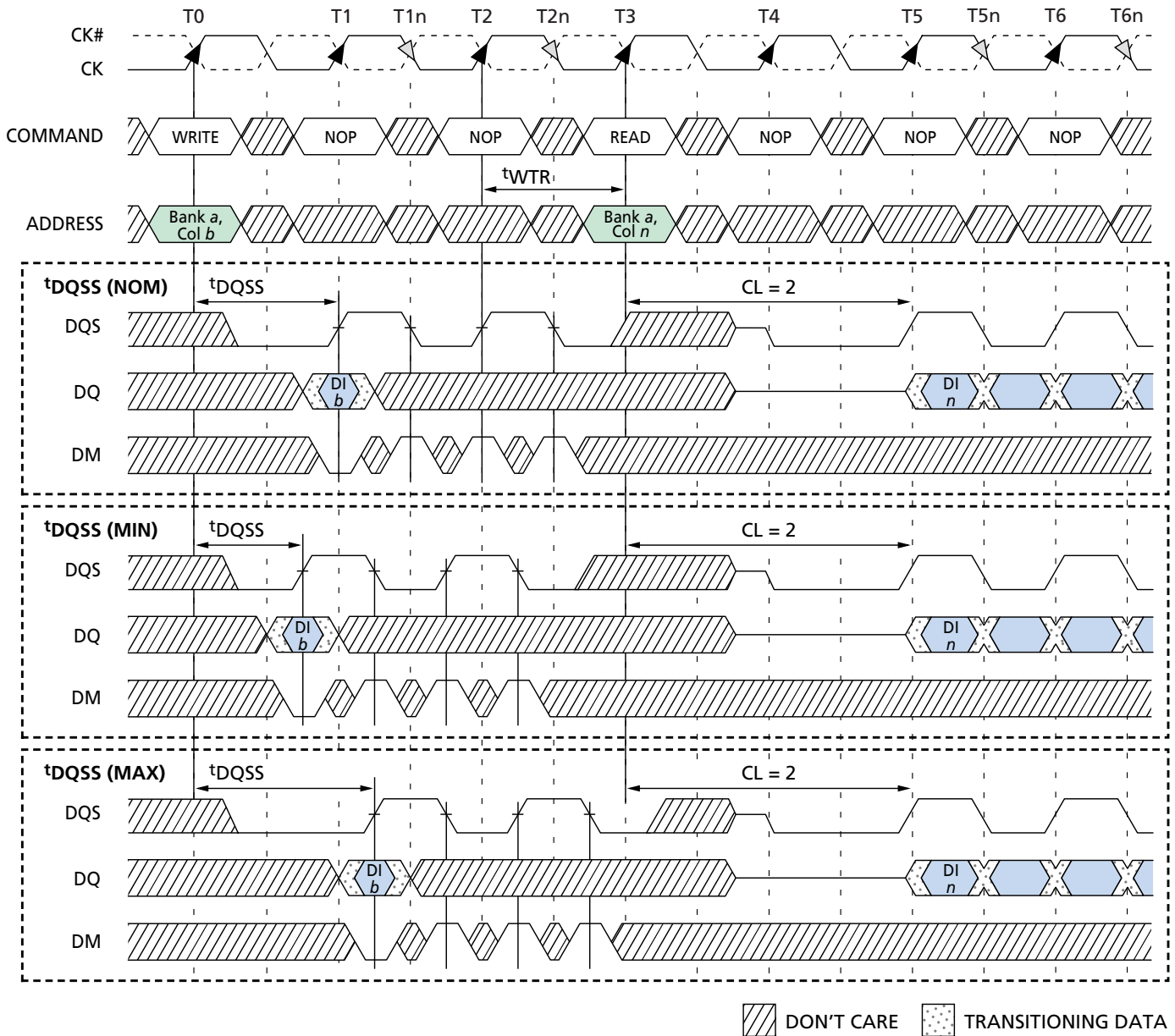

- NOTE:**
1. DI *b* = data-in for column *b*.
 2. An interrupted burst of 4 is shown; one data element is written.
 3. t_{WTR} is referenced from the first positive CK edge after the last desired data-in pair (not the last two data elements).
 4. A8 is LOW with the WRITE command (auto precharge is disabled).
 5. DQS is required at T1n, T2, and T2n (nominal case) to register DM.
 6. If the burst of 8 was used, DM would not be required at T3-T4n because the READ command would mask the last four data elements.

Figure 21
WRITE to READ – Odd Number of Data, Interrupting

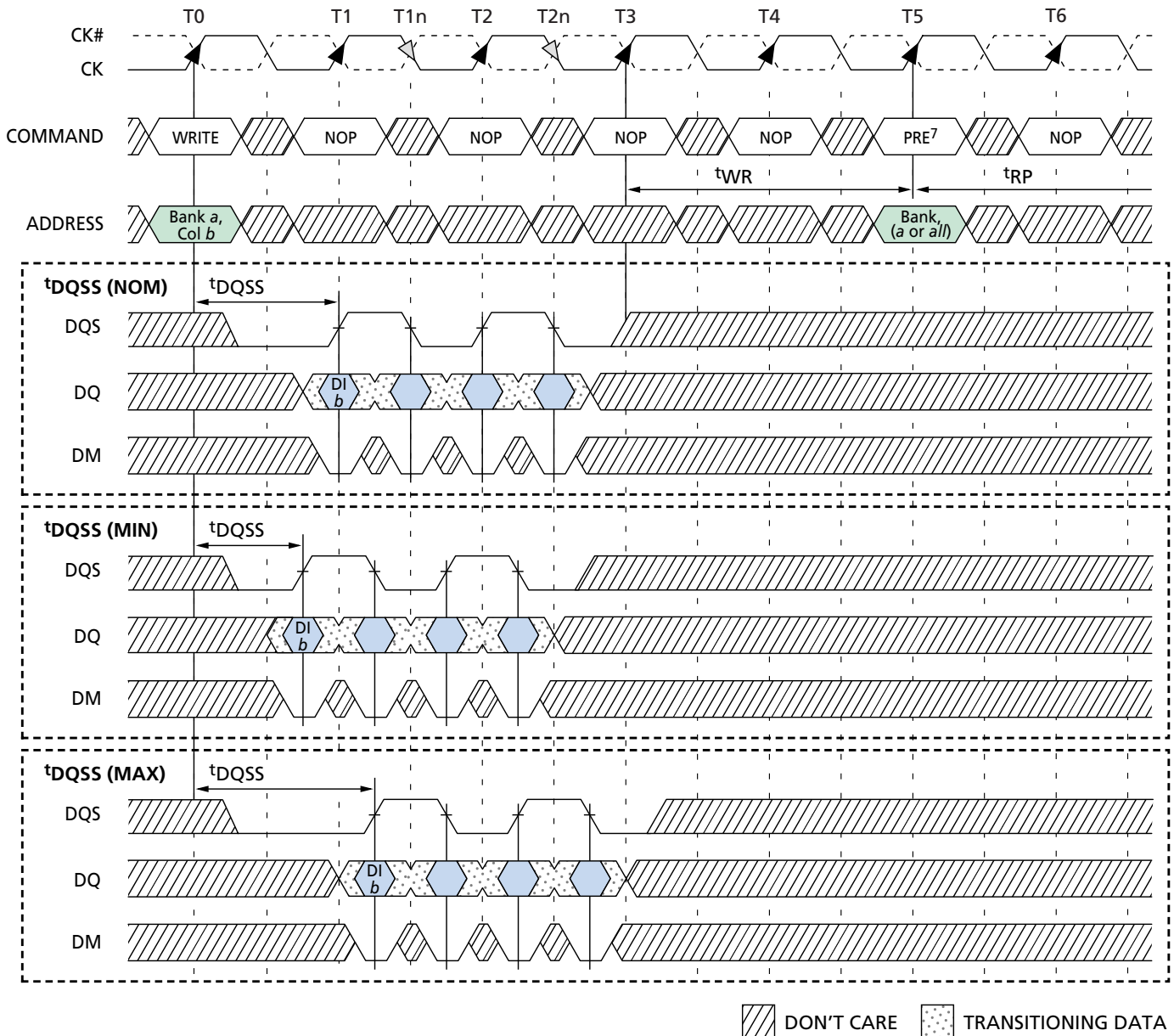

- NOTE:**
1. DI *b* = data-in for column *b*.
 2. Three subsequent elements of data-in are applied in the programmed order following DI *b*.
 3. An uninterrupted burst of 4 is shown.
 4. t_{WR} is referenced from the first positive CK edge after the last data-in pair.
 5. The PRECHARGE and WRITE commands are to the same bank. However, the PRECHARGE and WRITE commands may be to different devices, in which case t_{WR} is not required and the PRECHARGE command could be applied earlier.
 6. A8 is LOW with the WRITE command (auto precharge is disabled).
 7. PRE = PRECHARGE command.

**Figure 22
WRITE to PRECHARGE – Uninterrupting**

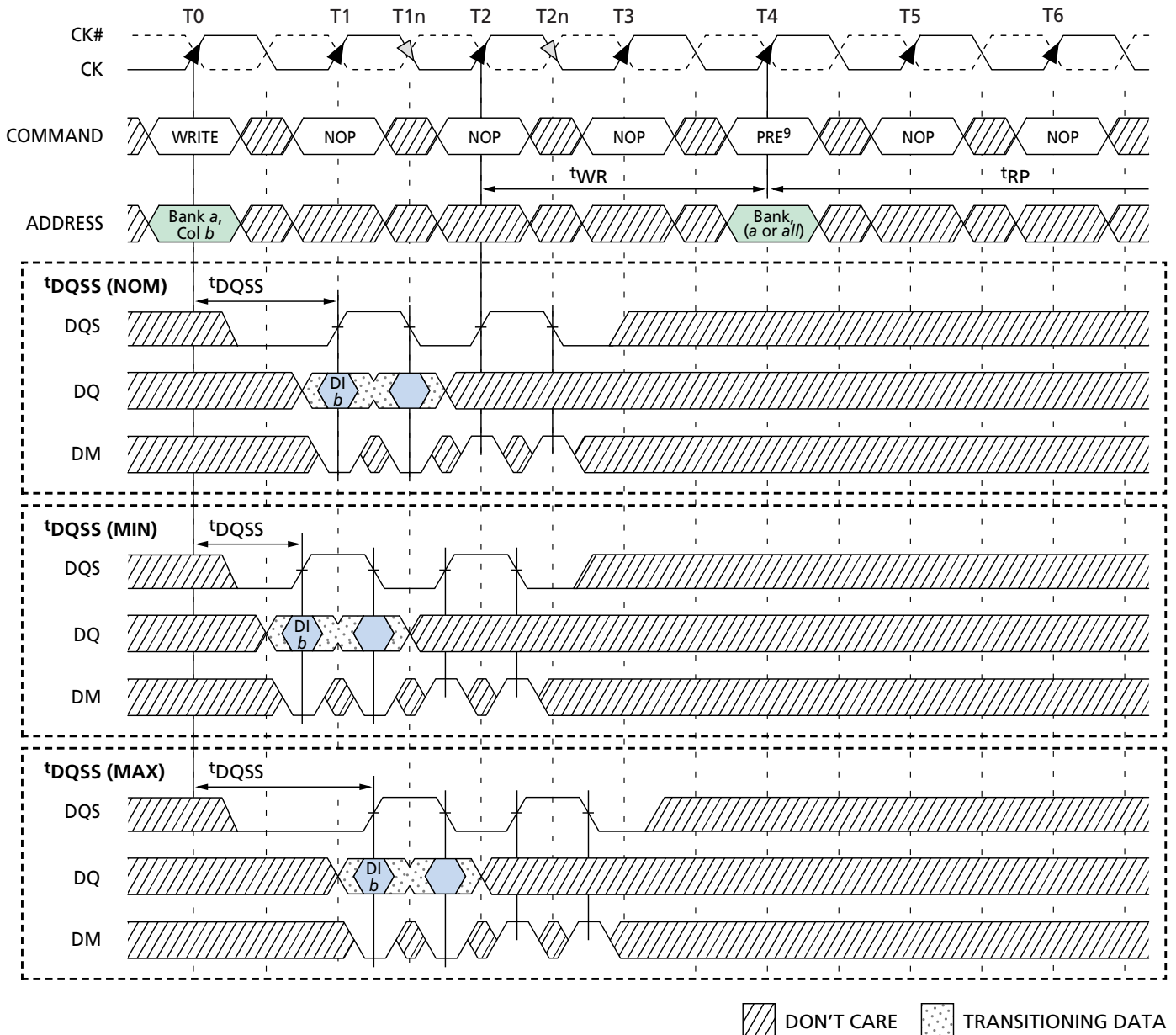

- NOTE:**
1. DI *b* = data-in for column *b*.
 2. Subsequent element of data-in is applied in the programmed order following DI *b*.
 3. An interrupted burst of 4 is shown; two data elements are written.
 4. t_{WR} is referenced from the first positive CK edge after the last data-in pair.
 5. The PRECHARGE and WRITE commands are to the same bank.
 6. A8 is LOW with the WRITE command (auto precharge is disabled).
 7. DQS is required at T2 and T2n (nominal case) to register DM.
 8. If the burst of 8 was used, DM would be required at T3 and T3n and not at T4 and T4n because the PRECHARGE command would mask the last two data elements.
 9. PRE = PRECHARGE command.

Figure 23
WRITE to Precharge – Interrupting

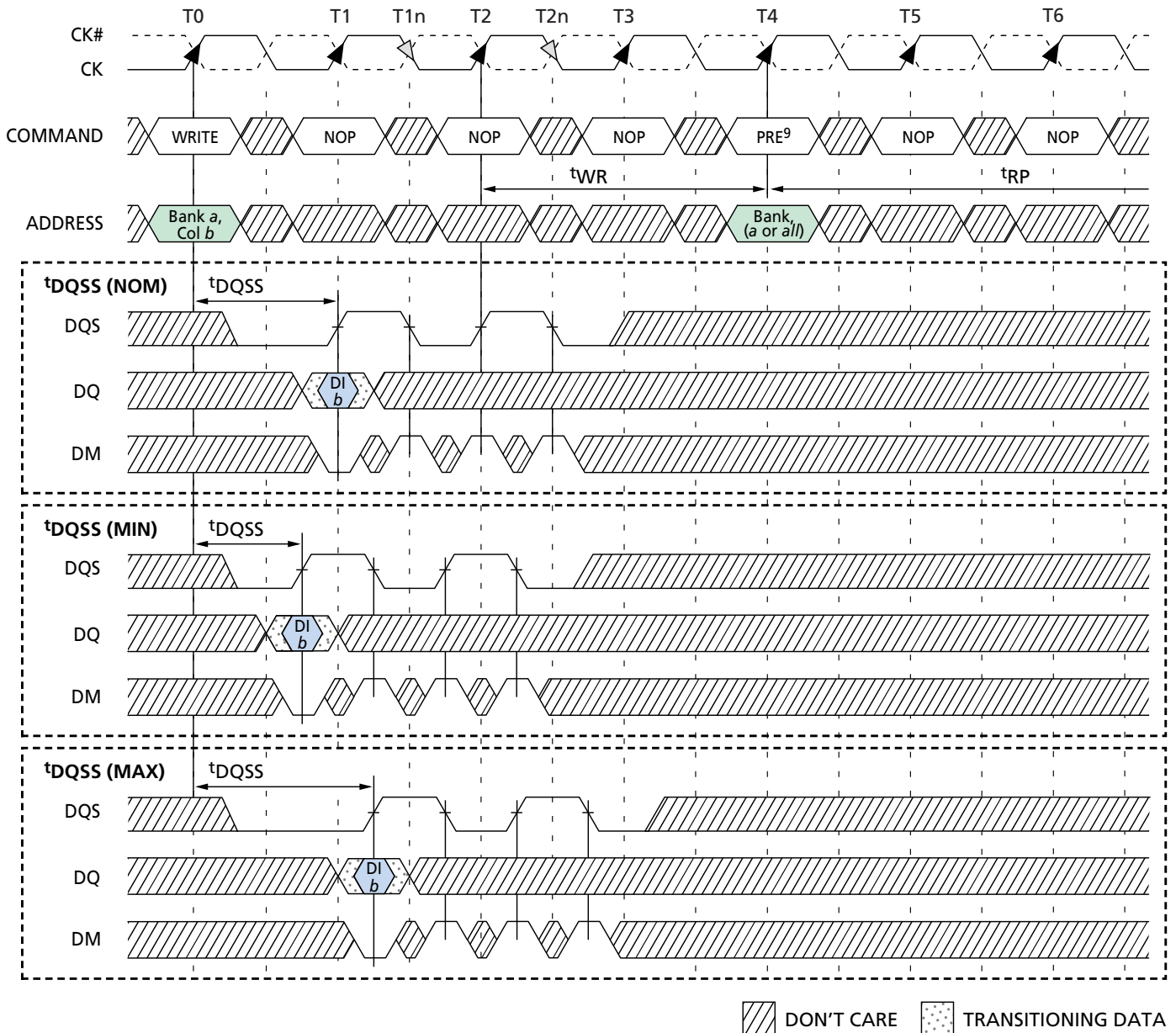

- NOTE:**
1. DI *b* = data-in for column *b*.
 2. Subsequent element of data-in is applied in the programmed order following DI *b*.
 3. An interrupted burst of 4 is shown; one data elements are written.
 4. t_{WR} is referenced from the first positive CK edge after the last data-in pair.
 5. The PRECHARGE and WRITE commands are to the same bank.
 6. A8 is LOW with the WRITE command (auto precharge is disabled).
 7. DQS is required at T1n, T2, and T2n (nominal case) to register DM.
 8. If the burst of 8 was used, DM would be required at T3 and T3n and not at T4 and T4n because the PRECHARGE command would mask the last two data elements.
 9. PRE = PRECHARGE command.

Figure 24
WRITE to PRECHARGE – Odd Number of Data, Interrupting

PRECHARGE

The PRECHARGE command (Figure 25) is used to deactivate the open row in a particular bank or the open row in all banks. The bank(s) will be available for a subsequent row access some specified time (t_{RP}) after the PRECHARGE command is issued. Input A8 determines whether one or all banks are to be precharged, and in the case where only one bank is to be precharged, inputs BA0, BA1 select the bank. When all banks are to be precharged, inputs BA0, BA1 are treated as “Don’t Care.” Once a bank has been precharged, it is in the idle state and must be activated prior to any READ or WRITE commands being issued to that bank.

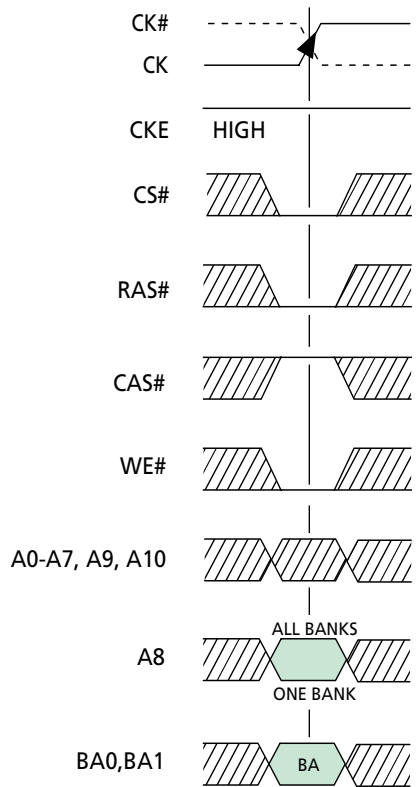

BA = Bank Address (if A8 is LOW; otherwise (Don t Care)

**Figure 25
PRECHARGE Command**

termines whether one or all banks are to be precharged, and in the case where only one bank is to be precharged, inputs BA0, BA1 select the bank. When all banks are to be precharged, inputs BA0, BA1 are treated as “Don’t Care.” Once a bank has been precharged, it is in the idle state and must be activated prior to any READ or WRITE commands being issued to that bank.

POWER-DOWN (CKE NOT ACTIVE)

Unlike SDR SDRAMs, DDR SDRAMs require CKE to be active at all times an access is in progress: from the issuing of a READ or WRITE command until completion of the burst. For READs, a burst completion is defined when the Read Postamble is satisfied; For WRITEs, a burst completion is defined when the Write Postamble is satisfied.

Power-down (Figure 26) is entered when CKE is registered LOW. If power-down occurs when all banks are idle, this mode is referred to as precharge power-down; if power-down occurs when there is a row active in any bank, this mode is referred to as active power-down. Entering power-down deactivates the input and output buffers, excluding CK, CK# and CKE. For maximum power savings, the DLL is frozen. Exiting power-down requires the device to be at the same voltage and frequency as when it entered power-down. However, power-down duration is limited by the refresh requirements of the device, so in most applications, the self-refresh mode is preferred over the DLL-disabled power-down mode.

While in power-down, CKE LOW and a stable clock signal must be maintained at the inputs of the DDR SDRAM, while all other input signals are “Don’t Care.”

The power-down state is synchronously exited when CKE is registered HIGH (in conjunction with a NOP or DESELECT command). A valid executable command may be applied one clock cycle later.

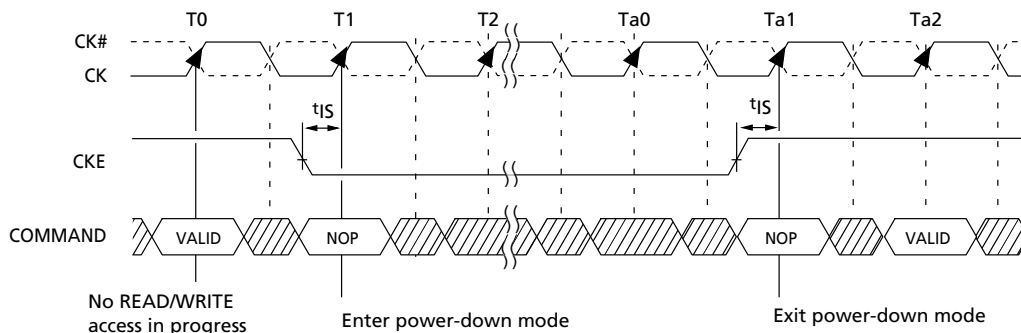

**Figure 26
Power-Down**

TRUTH TABLE 2 – CKE

(Notes: 1-4)

CKE _{n-1}	CKE _n	CURRENT STATE	COMMAND _n	ACTION _n	NOTES
L	L	Power-Down	X	Maintain Power-Down	
		Self Refresh	X	Maintain Self Refresh	
L	H	Power-Down	DESELECT or NOP	Exit Power-Down	
		Self Refresh	DESELECT or NOP	Exit Self Refresh	5
H	L	All Banks Idle	DESELECT or NOP	Precharge Power-Down Entry	
		Bank(s) Active	DESELECT or NOP	Active Power-Down Entry	
		All Banks Idle	AUTO REFRESH	Self Refresh Entry	
H	H		See Truth Table 3		

- NOTE:**
1. CKE_n is the logic state of CKE at clock edge *n*; CKE_{n-1} was the state of CKE at the previous clock edge.
 2. Current state is the state of the DDR SDRAM immediately prior to clock edge *n*.
 3. COMMAND_n is the command registered at clock edge *n*, and ACTION_n is a result of COMMAND_n.
 4. All states and sequences not shown are illegal or reserved.
 5. DESELECT or NOP commands should be issued on any clock edges occurring during the ^tXSR period. A minimum of 200 clock cycles is needed before applying a READ command for the DLL to lock.

TRUTH TABLE 3 – CURRENT STATE BANK *n* – COMMAND TO BANK *n*

(Notes: 1-6; notes appear below and on next page)

CURRENT STATE	CS#	RAS#	CAS#	WE#	COMMAND/ACTION	NOTES
Any	H	X	X	X	DESELECT (NOP/continue previous operation)	
	L	H	H	H	NO OPERATION (NOP/continue previous operation)	
Idle	L	L	H	H	ACTIVE (select and activate row)	
	L	L	L	H	AUTO REFRESH	7
	L	L	L	L	LOAD MODE REGISTER	7
Row Active	L	H	L	H	READ (select column and start READ burst)	10
	L	H	L	L	WRITE (select column and start WRITE burst)	10
	L	L	H	L	PRECHARGE (deactivate row in bank or banks)	8
Read (Auto-Precharge Disabled)	L	H	L	H	READ (select column and start new READ burst)	10
	L	H	L	L	WRITE (select column and start WRITE burst)	10, 12
	L	L	H	L	PRECHARGE (truncate READ burst, start PRECHARGE)	8
	L	H	H	L	BURST TERMINATE	9
Write (Auto-Precharge Disabled)	L	H	L	H	READ (select column and start READ burst)	10, 11
	L	H	L	L	WRITE (select column and start new WRITE burst)	10
	L	L	H	L	PRECHARGE (truncate WRITE burst, start PRECHARGE)	8, 11

NOTE:

- This table applies when CKE_{n-1} was HIGH and CKE_n is HIGH (see Truth Table 2) and after t_{XSNR} has been met (if the previous state was self refresh).
- This table is bank-specific, except where noted (i.e., the current state is for a specific bank and the commands shown are those allowed to be issued to that bank when in that state). Exceptions are covered in the notes below.
- Current state definitions:

Idle: The bank has been precharged, and t_{RP} has been met.

Row Active: A row in the bank has been activated, and t_{RCD} has been met. No data bursts/accesses and no register accesses are in progress.

Read: A READ burst has been initiated, with auto precharge disabled, and has not yet terminated or been terminated.

Write: A WRITE burst has been initiated, with auto precharge disabled, and has not yet terminated or been terminated.

- The following states must not be interrupted by a command issued to the same bank. COMMAND INHIBIT or NOP commands, or allowable commands to the other bank should be issued on any clock edge occurring during these states. Allowable commands to the other bank are determined by its current state and Truth Table 3, and according to Truth Table 4.

Precharging: Starts with registration of a PRECHARGE command and ends when t_{RP} is met. Once t_{RP} is met, the bank will be in the idle state.

Row Activating: Starts with registration of an ACTIVE command and ends when t_{RCD} is met. Once t_{RCD} is met, the bank will be in the "row active" state.

Read w/Auto-Precharge Enabled: Starts with registration of a READ command with auto precharge enabled and ends when t_{RP} has been met. Once t_{RP} is met, the bank will be in the idle state.

Write w/Auto-Precharge Enabled: Starts with registration of a WRITE command with auto precharge enabled and ends when t_{RP} has been met. Once t_{RP} is met, the bank will be in the idle state.

NOTE (continued):

5. The following states must not be interrupted by any executable command; COMMAND INHIBIT or NOP commands must be applied on each positive clock edge during these states.
 - Refreshing: Starts with registration of an AUTO REFRESH command and ends when t^{RC} is met. Once t^{RC} is met, the DDR SDRAM will be in the all banks idle state.
 - Accessing Mode
 - Register: Starts with registration of a LOAD MODE REGISTER command and ends when t^{MRD} has been met. Once t^{MRD} is met, the DDR SDRAM will be in the all banks idle state.
 - Precharging All: Starts with registration of a PRECHARGE ALL command and ends when t^{RP} is met. Once t^{RP} is met, all banks will be in the idle state.
6. All states and sequences not shown are illegal or reserved.
7. Not bank-specific; requires that all banks are idle, and bursts are not in progress.
8. May or may not be bank-specific; if multiple banks are to be precharged, each must be in a valid state for precharging.
9. Not bank-specific; BURST TERMINATE affects the most recent READ burst, regardless of bank.
10. READs or WRITEs listed in the Command/Action column include READs or WRITEs with auto precharge enabled and READs or WRITEs with auto precharge disabled.
11. Requires appropriate DM masking.
12. A WRITE command may be applied after the completion of the READ burst; otherwise, a BURST TERMINATE must be used to end the READ burst prior to asserting a WRITE command.

TRUTH TABLE 4 – CURRENT STATE BANK n – COMMAND TO BANK m

(Notes: 1-9; notes appear below and on next page)

CURRENT STATE	CS#	RAS#	CAS#	WE#	COMMAND/ACTION	NOTES
Any	H	X	X	X	DESELECT (NOP/continue previous operation)	
	L	H	H	H	NO OPERATION (NOP/continue previous operation)	
Idle	X	X	X	X	Any Command Otherwise Allowed to Bank m	
Row Activating, Active, or Precharging	L	L	H	H	ACTIVE (select and activate row)	
	L	H	L	H	READ (select column and start READ burst)	7
	L	H	L	L	WRITE (select column and start WRITE burst)	7
	L	L	H	L	PRECHARGE	
Read (Auto- Precharge Disabled)	L	L	H	H	ACTIVE (select and activate row)	
	L	H	L	H	READ (select column and start new READ burst)	7
	L	H	L	L	WRITE (select column and start WRITE burst)	7, 9
	L	L	H	L	PRECHARGE	
Write (Auto- Precharge Disabled)	L	L	H	H	ACTIVE (select and activate row)	
	L	H	L	H	READ (select column and start READ burst)	7, 8
	L	H	L	L	WRITE (select column and start new WRITE burst)	7
	L	L	H	L	PRECHARGE	
Read (With Auto- Precharge)	L	L	H	H	ACTIVE (select and activate row)	
	L	H	L	H	READ (select column and start new READ burst)	7, 3a
	L	H	L	L	WRITE (select column and start WRITE burst)	7, 9, 3a
	L	L	H	L	PRECHARGE	
Write (With Auto- Precharge)	L	L	H	H	ACTIVE (select and activate row)	
	L	H	L	H	READ (select column and start READ burst)	7, 3a
	L	H	L	L	WRITE (select column and start new WRITE burst)	7, 3a
	L	L	H	L	PRECHARGE	

- NOTE:**
- This table applies when CKE_{n-1} was HIGH and CKE_n is HIGH (see Truth Table 2) and after t_{XSNR} has been met (if the previous state was self refresh).
 - This table describes alternate bank operation, except where noted (i.e., the current state is for bank n and the commands shown are those allowed to be issued to bank m , assuming that bank m is in such a state that the given command is allowable). Exceptions are covered in the notes below.
 - Current state definitions:

Idle: The bank has been precharged, and t_{RP} has been met.

Row Active: A row in the bank has been activated, and t_{RCD} has been met. No data bursts/accesses and no register accesses are in progress.

Read: A READ burst has been initiated, with auto precharge disabled, and has not yet terminated or been terminated.

Write: A WRITE burst has been initiated, with auto precharge disabled, and has not yet terminated or been terminated.

Read with Auto
Precharge Enabled: See following text - 3a

Write with Auto
Precharge Enabled: See following text - 3a

NOTES (continued):

- 3a. The READ with auto precharge enabled or WRITE with auto precharge enabled states can each be broken into two parts: the access period and the precharge period. For READ with auto precharge, the precharge period is defined as if the same burst was executed with auto precharge disabled and then followed with the earliest possible PRECHARGE command that still accesses all of the data in the burst. For WRITE with auto precharge, the precharge period begins when t^1_{WR} ends, with t^1_{WR} measured as if auto precharge was disabled. The access period starts with registration of the command and ends where the precharge period (or t^1_{RP}) begins.
During the precharge period of the READ with auto precharge enabled or WRITE with auto precharge enabled states, ACTIVE, PRECHARGE, READ, and WRITE commands to the other bank may be applied; during the access period, only ACTIVE and PRECHARGE commands to the other bank may be applied. In either case, all other related limitations apply (e.g., contention between read data and write data must be avoided).
4. AUTO REFRESH and LOAD MODE REGISTER commands may only be issued when all banks are idle.
5. A BURST TERMINATE command cannot be issued to another bank; it applies to the bank represented by the current state only.
6. All states and sequences not shown are illegal or reserved.
7. READs or WRITEs listed in the Command/Action column include READs or WRITEs with auto precharge enabled and READs or WRITEs with auto precharge disabled.
8. Requires appropriate DM masking.
9. A WRITE command may be applied after the completion of the READ burst; otherwise, a BURST TERMINATE must be used to end the READ burst prior to asserting a WRITE command.

ABSOLUTE MAXIMUM RATINGS*

Voltage on V _{DD} Supply	Relative to V _{SS}	-1V to +3.6V
Voltage on V _{DDQ} Supply	Relative to V _{SS}	-1V to +3.6V
Voltage on V _{REF} and Inputs	Relative to V _{SS}	-1V to +3.6V
Voltage on I/O Pins	Relative to V _{SS}	-0.5V to V _{DDQ} +0.5V
Operating Temperature, T _A (ambient) ..		0°C to +70°C
Storage Temperature (plastic)		-55°C to +150°C
Power Dissipation		1W
Short Circuit Output Current		50mA

*Stresses greater than those listed under “Absolute Maximum Ratings” may cause permanent damage to the device. This is a stress rating only, and functional operation of the device at these or any other conditions above those indicated in the operational sections of this specification is not implied. Exposure to absolute maximum rating conditions for extended periods may affect reliability.

DC ELECTRICAL CHARACTERISTICS AND OPERATING CONDITIONS

(Notes: 1-5, 16; notes appear on pages 47-50) (0°C ≤ T_A ≤ +70°C;)

PARAMETER/CONDITION	SYMBOL	MIN	MAX	UNITS	NOTES
Supply Voltage, Part Type 2.5V/2.65V	V _{DD}	2.4/2.55	2.6/2.75	V	42
I/O Supply Voltage, Part Type 2.5V/2.65V	V _{DDQ}	2.4/2.55	2.6/2.75	V	42
I/O Reference Voltage	V _{REF}	0.49 x V _{DDQ}	0.51 x V _{DDQ}	V	6,44
I/O Termination Voltage (system)	V _{TT}	V _{REF} - 0.04	V _{REF} + 0.04	V	7,44
Input High (Logic 1) Voltage	V _{IH(DC)}	V _{REF} + 0.15	V _{DD} + 0.3	V	28
Input Low (Logic 0) Voltage	V _{IL(DC)}	-0.3	V _{REF} - 0.15	V	28
Clock Input Voltage Level; CK and CK#	V _{IN}	-0.3	V _{DDQ} + 0.3	V	
Clock Input Differential Voltage; CK and CK#	V _{ID}	0.36	V _{DDQ} + 0.6	V	8
Clock Input Crossing Point Voltage; CK and CK#	V _{IX}	1.2	1.4	V	9,43
Input Leakage Current: Any input 0V ≤ V _{IN} ≤ V _{DD} (All other pins not under test = 0V)	I _I	-2	2	μA	
Output Leakage Current: (DQs are disabled; 0V ≤ V _{OUT} ≤ V _{DDQ})	I _{OZ}	-5	5	μA	
Output Levels: Impedance Match High Current (V _{OUT} = V _{DDQ} -0.373V, minimum V _{REF} , minimum V _{TT}) Low Current (V _{OUT} = 0.373V, maximum V _{REF} , maximum V _{TT})	I _{OH} I _{OL}	-4 4	- -	mA mA	37, 39
Output Levels: Reduced drive option High Current (V _{OUT} = V _{DDQ} -0.763V, minimum V _{REF} , minimum V _{TT}) Low Current (V _{OUT} = 0.763V, maximum V _{REF} , maximum V _{TT})	I _{OHR} I _{OLR}	-9 9	- -	mA mA	38, 39

AC INPUT OPERATING CONDITIONS

(Notes: 1-5, 14, 16; notes appear on pages 47-50) (0°C ≤ T_A ≤ +70°C;)

PARAMETER/CONDITION	SYMBOL	MIN	MAX	UNITS	NOTES
Input High (Logic 1) Voltage; DQ	V _{IH(AC)}	V _{REF} + 0.310	-	V	28, 39
Input Low (Logic 0) Voltage; DQ	V _{IL(AC)}	-	V _{REF} - 0.310	V	28, 39
Clock Input Differential Voltage; CK and CK#	V _{ID(AC)}	0.7	V _{DDQ} + 0.6	V	8
Clock Input Crossing Point Voltage; CK and CK#	V _{IX(AC)}	0.5 x V _{DDQ} -0.2	0.5 x V _{DDQ} +0.2	V	9

CLOCK INPUT OPERATING CONDITIONS

 (Notes: 1–5, 15, 16; notes appear on pages 47–50) ($0^{\circ}\text{C} \leq T_A \leq +70^{\circ}\text{C}$; $V_{DD} = +2.5\text{V} \pm 0.1\text{V}$, $V_{DDQ} = +2.5\text{V} \pm 0.1\text{V}$)

PARAMETER/CONDITION	SYMBOL	MIN	MAX	UNITS	NOTES
Clock Input Mid-Point Voltage; CK and CK#	$V_{MP(DC)}$	1.05	1.45	V	6, 9
Clock Input Voltage Level; CK and CK#	$V_{IN(DC)}$	-0.3	$V_{DDQ} + 0.3$	V	6
Clock Input Differential Voltage; CK and CK#	$V_{ID(DC)}$	0.36	$V_{DDQ} + 0.6$	V	6, 8
Clock Input Differential Voltage; CK and CK#	$V_{ID(AC)}$	0.7	$V_{DDQ} + 0.6$	V	8
Clock Input Crossing Point Voltage; CK and CK#	$V_{IX(AC)}$	$0.5 \times V_{DDQ} - 0.2$	$0.5 \times V_{DDQ} + 0.2$	V	9

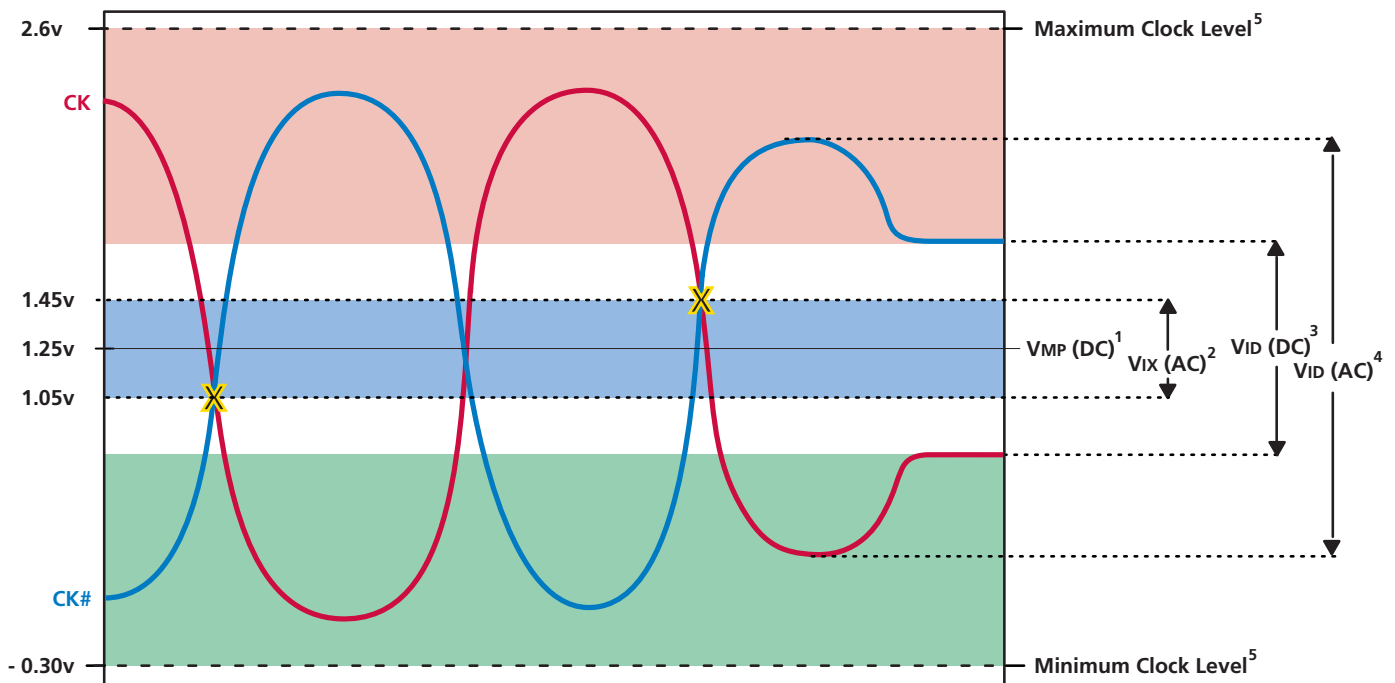

- NOTE:**
1. This provides a minimum of 1.225v to a maximum of 1.425v, and is always half of V_{DDQ} .
 2. CK and CK# must cross in this region.
 3. CK and CK# must meet at least $V_{ID(DC)}$ min when static and is centered around $V_{MP(DC)}$.
 4. CK and CK# must have a minimum 700mv peak to peak swing.
 5. CK or CK# may not be more positive than $V_{DDQ} + 0.5\text{v}$ or more negative than $V_{SS} - 0.5\text{v}$.
 6. For AC operation, all DC clock requirements must also be satisfied.
 7. Numbers in diagram reflect nominal values.

FIGURE 27A – SSTL_2 CLOCK INPUT

CLOCK INPUT OPERATING CONDITIONS

 (Notes: 1–5, 15, 16; notes appear on pages 47–50) ($0^{\circ}\text{C} \leq T_A \leq +70^{\circ}\text{C}$; $V_{DD} = +2.65\text{V} \pm 0.1\text{V}$, $V_{DDQ} = +2.65\text{V} \pm 0.1\text{V}$)

PARAMETER/CONDITION	SYMBOL	MIN	MAX	UNITS	NOTES
Clock Input Mid-Point Voltage; CK and CK#	$V_{MP(DC)}$	1.05	1.45	V	6, 9
Clock Input Voltage Level; CK and CK#	$V_{IN(DC)}$	-0.3	$V_{DDQ} + 0.3$	V	6
Clock Input Differential Voltage; CK and CK#	$V_{ID(DC)}$	0.36	$V_{DDQ} + 0.6$	V	6, 8
Clock Input Differential Voltage; CK and CK#	$V_{ID(AC)}$	0.7	$V_{DDQ} + 0.6$	V	8
Clock Input Crossing Point Voltage; CK and CK#	$V_{IX(AC)}$	$0.5 \times V_{DDQ} - 0.2$	$0.5 \times V_{DDQ} + 0.2$	V	9

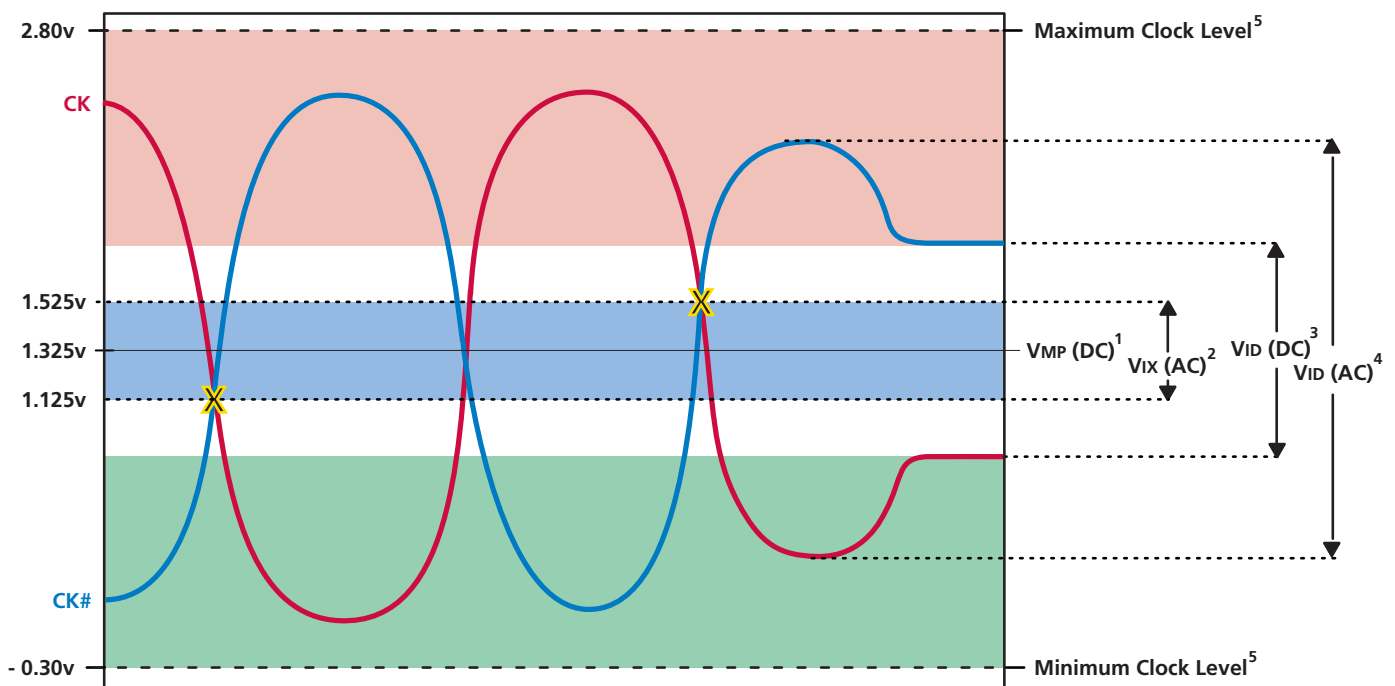

- NOTE:**
1. This provides a minimum of 1.225v to a maximum of 1.425v, and is always half of V_{DDQ} .
 2. CK and CK# must cross in this region.
 3. CK and CK# must meet at least $V_{ID(DC)}$ min when static and is centered around $V_{MP(DC)}$.
 4. CK and CK# must have a minimum 700mv peak to peak swing.
 5. CK or CK# may not be more positive than $V_{DDQ} + 0.5\text{v}$ or more negative than $V_{SS} - 0.5\text{v}$.
 6. For AC operation, all DC clock requirements must also be satisfied.
 7. Numbers in diagram reflect nominal values.

FIGURE 27B – SSTL_2 CLOCK INPUT

CAPACITANCE

(Note: 13; notes appear on pages 47–50)

PARAMETER	SYMBOL	MIN	MAX	UNITS	NOTES
Delta Input/Output Capacitance: DQs, DQS, DM	DC _{IO}	–	0.50	pF	29
Delta Input Capacitance: Command and Address	DC _{I1}	–	0.50	pF	29
Delta Input Capacitance: CK, CK#	DC _{I2}	–	0.25	pF	29
Input/Output Capacitance: DQs, DQS, DM	C _{IO}	4.0	5.0	pF	
Input Capacitance: Command and Address	C _{I1}	2.0	3.0	pF	
Input Capacitance: CK, CK#	C _{I2}	2.0	3.5	pF	
Input Capacitance: CKE	C _{I3}	2.0	3.5	pF	

I_{DD} SPECIFICATIONS AND CONDITIONS

(Notes: 1-5, 10, 12, 14; notes appear on pages 47–50) (0°C ≤ T_A ≤ +70°C; V_{DDQ} = 2.5V/+2.65V, V_{DD}=2.5V/+2.65V)

PARAMETER/CONDITION	SYMBOL	MAX				UNITS	NOTES	
		-5	-55	-6	-65			
Operating Current: One bank; Active-Precharge; t _{RC} = t _{RC} MIN; t _{CK} = t _{CK} (MIN); DQ, DM, and DQS inputs changing twice per clock cycle; Address and control inputs changing once per clock cycle	I _{DD0}	180	175	165	155	mA	22	
Operating Current: One bank; Active-Read-Precharge; Burst = 2; t _{RC} = t _{RC} (MIN); t _{CK} = t _{CK} (MIN); I _{OUT} = 0mA; Address and control inputs changing once per clock cycle	I _{DD1}	200	195	190	185	mA	22	
Precharge Power-Down Standby Current: All banks idle; Power-down mode; t _{CK} = t _{CK} (MIN); CKE = LOW	I _{DD2P}	3	3	3	3	mA	32	
Idle Standby Current: CS# = HIGH; All banks idle; t _{CK} = t _{CK} (MIN); CKE = HIGH; Address and other control inputs changing once per clock cycle	I _{DD2N}	120	110	100	90	mA		
Active Power-Down Standby Current: One bank active; Power-down mode; t _{CK} = t _{CK} (MIN); CKE = LOW	I _{DD3P}	70	65	60	55	mA	32	
Active Standby Current: CS# = HIGH; CKE = HIGH; One bank; Active-Precharge; t _{RC} = t _{RAS} (MAX); t _{CK} = t _{CK} (MIN); DQ, DM, and DQS inputs changing twice per clock cycle; Address and other control inputs changing once per clock cycle	I _{DD3N}	125	113	105	95	mA	22	
Operating Current: Burst = 2; Reads; Continuous burst; One bank active; Address and control inputs changing once per clock cycle; t _{CK} = t _{CK} (MIN); I _{OUT} = 0mA	I _{DD4R}	355	330	310	295	mA		
Operating Current: Burst = 2; Writes; Continuous burst; One bank active; Address and control inputs changing once per clock cycle; t _{CK} = t _{CK} (MIN); DQ, DM, and DQS inputs changing twice per clock cycle	I _{DD4W}	270	250	240	220	mA		
Auto Refresh Current	t _{RC} = t _{RFC} (MIN)	I _{DD5}	245	245	245	245	mA	22
	t _{RC} = 7.8μs	I _{DD6}	3.5	3.5	3.5	3.5	mA	27
Self Refresh Current: CKE ≤ 0.2V	Standard	I _{DD7}	2	2	2	2	mA	11

ELECTRICAL CHARACTERISTICS AND RECOMMENDED AC OPERATING CONDITIONS

 (Notes: 1-5, 14-17, 33; notes appear on pages 47–50) ($0^{\circ}\text{C} \leq T_A \leq +70^{\circ}\text{C}$; $V_{DDQ} = +2.5\text{V}/+2.65\text{V}$, $V_{DD} = +2.5\text{V}/+2.65\text{V}$)

AC CHARACTERISTICS			-5		-55			
PARAMETER		SYMBOL	MIN	MAX	MIN	MAX	UNITS	NOTES
Access window of DQs from CK/CK#		t^{AC}	-0.75	+0.75	-0.75	+0.75	ns	
CK high-level width		t^{CH}	0.45	0.55	0.45	0.55	t^{CK}	30
CK low-level width		t^{CL}	0.45	0.55	0.45	0.55	t^{CK}	30
Clock cycle time	CL = 3	$t^{\text{CK}}(3)$	5	12	5.5	12	ns	41
	CL = 2	$t^{\text{CK}}(2)$	8	12	10	12	ns	41
DQ and DM input hold time relative to DQS		t^{DH}	0.6		0.6		ns	26, 31
DQ and DM input setup time relative to DQS		t^{DS}	0.6		0.6		ns	26, 31
DQ and DM input pulse width (for each input)		t^{DIPW}	1.25		1.4		ns	31
Access window of DQS from CK/CK#		t^{DQSCK}	-0.75	+0.75	-0.75	+0.75	ns	
DQS input high pulse width		t^{DQSH}	0.4		0.4		t^{CK}	
DQS input low pulse width		t^{DQSL}	0.4		0.4		t^{CK}	
DQS-DQ skew, DQS to last DQ valid, per group, per access		t^{DQSQ}		0.5		0.5	ns	25, 26
Write command to first DQS latching transition		t^{DQSS}	0.75	1.25	0.75	1.25	t^{CK}	
DQS falling edge to CK rising - setup time		t^{DSS}	0.25		0.25		t^{CK}	
DQS falling edge from CK rising - hold time		t^{DSH}	0.25		0.25		t^{CK}	
Half clock period		t^{HP}	$t^{\text{CH}}, t^{\text{CL}}$		$t^{\text{CH}}, t^{\text{CL}}$		ns	34
Data-out high-impedance window from CK/CK#		t^{HZ}	-0.5		-0.55		ns	18
Data-out low-impedance window from CK/CK#		t^{LZ}	-0.5		-0.55		ns	18
Address and control input hold time		t^{IH}	1		1		ns	14
Address and control input setup time		t^{IS}	1		1		ns	14
Address and control input pulse width		t^{IPW}	1.6		1.6		ns	
LOAD MODE REGISTER command cycle time		t^{MRD}	2		2		t^{CK}	
DQ-DQS hold, DQS to first DQ to go non-valid, per access		t^{QH}	t^{HP}		t^{HP}		ns	25, 26
			-0.55ns		-0.6ns			34
ACTIVE to PRECHARGE command		t^{RAS}	40	120K	40	120K	ns	35
ACTIVE to READ with Auto precharge command		t^{RAP}	$t^{\text{RAS}}(\text{MIN}) - (\text{burst length} * t^{\text{CK}}/2)$				ns	45
ACTIVE to ACTIVE/AUTOREFRESH command period		t^{RC}	60		56.5		ns	
AUTOREFRESH command period		t^{RFC}	66		66		ns	40
REFRESH to REFRESH command interval ¹		t^{REFC}					μs	23
Average periodic refresh interval		t^{REFI}		7.8		7.8	μs	23
ACTIVE to READ or WRITE delay		t^{RCD}	20		22		ns	
PRECHARGE command period		t^{RP}	20		22		ns	
DQS Read preamble		t^{RPRE}	0.9	1.1	0.9	1.1	t^{CK}	
DQS Read postamble		t^{RPST}	0.4	0.6	0.4	0.6	t^{CK}	
ACTIVE bank a to ACTIVE bank b command		t^{RRD}	2		2		t^{CK}	
Terminating voltage delay to V_{DD}		t^{VTD}	0		0		ns	
DQS Write preamble		t^{WPRE}	0.25		0.25		t^{CK}	
DQS Write preamble setup time		t^{WPRES}	0		0		ns	20, 21
DQS Write postamble		t^{WPST}	0.4	0.6	0.4	0.6	t^{CK}	19
Write recovery time		t^{WR}	2		2		t^{CK}	
Internal WRITE to READ command delay		t^{WTR}	1		1		t^{CK}	
Exit SELF REFRESH to non-READ command		t^{XSNR}	65		66		ns	
Exit SELF REFRESH to READ command		t^{XSRD}	200		200		t^{CK}	
Data valid output window		na	$t^{\text{QH}} - t^{\text{DQSQ}}$		$t^{\text{QH}} - t^{\text{DQSQ}}$		ns	25

ELECTRICAL CHARACTERISTICS AND RECOMMENDED AC OPERATING CONDITIONS

 (Notes: 1-5, 14-17, 33; notes appear on pages 47–50) ($0^{\circ}\text{C} \leq T_A \leq +70^{\circ}\text{C}$; $V_{DDQ} = +2.65\text{V}$, $V_{DD} = +2.65\text{V}$)

AC CHARACTERISTICS			-6		-65			
PARAMETER		SYMBOL	MIN	MAX	MIN	MAX	UNITS	NOTES
Access window of DQs from CK/CK#		t_{AC}	-0.75	+0.75	-0.75	+0.75	ns	
CK high-level width		t_{CH}	0.45	0.55	0.45	0.55	t_{CK}	30
CK low-level width		t_{CL}	0.45	0.55	0.45	0.55	t_{CK}	30
Clock cycle time	CL = 3	$t_{CK}(3)$	6	12	6.5	12	ns	41
	CL = 2	$t_{CK}(2)$	10	12	10	12	ns	
DQ and DM input hold time relative to DQS		t_{DH}	0.6		0.6		ns	26, 31
DQ and DM input setup time relative to DQS		t_{DS}	0.6		0.6		ns	26, 31
DQ and DM input pulse width (for each input)		t_{DIPW}	1.5		1.5		ns	31
Access window of DQS from CK/CK#		t_{DQSCK}	-0.75	+0.75	-0.75	+0.75	ns	
DQS input high pulse width		t_{DQSH}	0.4		0.4		t_{CK}	
DQS input low pulse width		t_{DQSL}	0.4		0.4		t_{CK}	
DQS-DQ skew, DQS to last DQ valid, per group, per access		t_{DQSQ}		0.5		0.5	ns	25, 26
Write command to first DQS latching transition		t_{DQSS}	0.75	1.25	0.75	1.25	t_{CK}	
DQS falling edge to CK rising - setup time		t_{DSS}	0.25		0.25		t_{CK}	
DQS falling edge from CK rising - hold time		t_{DSH}	0.2		0.2		t_{CK}	
Half clock period		t_{HP}	t_{CH}, t_{CL}		t_{CH}, t_{CL}		ns	34
Data-out high-impedance window from CK/CK#		t_{HZ}	-0.6		-0.65		ns	18
Data-out low-impedance window from CK/CK#		t_{LZ}	-0.6		-0.65		ns	18
Address and control input hold time		t_{IH}	1		1		ns	14
Address and control input setup time		t_{IS}	1		1		ns	14
Address and control input pulse width		t_{IPW}	2		2		ns	
LOAD MODE REGISTER command cycle time		t_{MRD}	2		2		t_{CK}	
DQ-DQS hold, DQS to first DQ to go non-valid, per access		t_{QH}	t_{HP}		t_{HP}		ns	25, 26
			-0.65ns		-0.7ns			34
ACTIVE to PRECHARGE command		t_{RAS}	40	120K	40	120K	ns	35
ACTIVE to READ with Auto precharge command		t_{RAP}	$t_{RAS}(\text{MIN}) - (\text{burst length} * t_{CK}/2)$				ns	45
ACTIVE to ACTIVE/AUTO REFRESH command period		t_{RC}	58		59.5		ns	
AUTO REFRESH command period		t_{RFC}	66		66		ns	40
REFRESH to REFRESH command interval		t_{REFC}					μs	23
Average periodic refresh interval		t_{REFI}		7.8		7.8	μs	23
ACTIVE to READ or WRITE delay		t_{RCD}	18		19.5		ns	
PRECHARGE command period		t_{RP}	18		19.5		ns	
DQS Read preamble		t_{RPRE}	0.9	1.1	0.9	1.1	t_{CK}	
DQS Read postamble		t_{RPST}	0.4	0.6	0.4	0.6	t_{CK}	
ACTIVE bank a to ACTIVE bank b command		t_{RRD}	2		2		t_{CK}	
Terminating voltage delay to V_{DD}		t_{VTD}	0		0		ns	
DQS Write preamble		t_{WPRE}	0.25		0.25		t_{CK}	
DQS Write preamble setup time		t_{WPRES}	0	0	0	0	ns	20, 21
DQS Write postamble		t_{WPST}	0.4	0.6	0.4	0.6	t_{CK}	19
Write recovery time		t_{WR}	2		2		t_{CK}	
Internal WRITE to READ command delay		t_{WTR}	1		1		t_{CK}	
Exit SELF REFRESH to non-READ command		t_{XSNR}	66		66		ns	
Exit SELF REFRESH to READ command		t_{XSRD}	200		200		t_{CK}	
Data valid output window		na	$t_{QH} - t_{DQSQ}$		$t_{QH} - t_{DQSQ}$		ns	25

NOTES

1. All voltages referenced to V_{SS} .
2. Tests for AC timing, I_{DD} , and electrical AC and DC characteristics may be conducted at nominal reference/supply voltage levels, but the related specifications and device operation are guaranteed for the full voltage range specified.
3. Outputs measured with equivalent load:

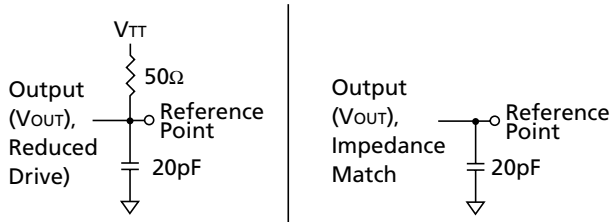

4. AC timing and I_{DD} tests may use a V_{IL} -to- V_{IH} swing of up to 1.5V in the test environment, but input timing is still referenced to V_{REF} (or to the crossing point for CK/CK#), and parameter specifications are guaranteed for the specified AC input levels under normal use conditions. The minimum slew rate for the input signals used to test the device is 1V/ns in the range between $V_{IL(AC)}$ and $V_{IH(AC)}$.
5. The AC and DC input level specifications are as defined in the SSTL_2 Standard (i.e., the receiver will effectively switch as a result of the signal crossing the AC input level, and will remain in that state as long as the signal does not ring back above [below] the DC input LOW [HIGH] level).
6. V_{REF} is expected to equal $V_{DDQ}/2$ of the transmitting device and to track variations in the DC level of the same. Peak-to-peak noise on V_{REF} may not exceed ± 2 percent of the DC value. Thus, from $V_{DDQ}/2$, V_{REF} is allowed ± 25 mV for DC error and an additional ± 25 mV for AC noise.
7. V_{TT} is not applied directly to the device. V_{TT} is a system supply for signal termination resistors, is expected to be set equal to V_{REF} and must track variations in the DC level of V_{REF} .
8. V_{ID} is the magnitude of the difference between the input level on CK and the input level on CK#.
9. The value of V_{IX} is expected to equal $V_{DDQ}/2$ of the transmitting device and must track variations in the DC level of the same.
10. I_{DD} is dependent on output loading and cycle rates. Specified values are obtained with minimum cycle time at $CL = 3$. Outputs are open during I_{DD} measurements.
11. Enables on-chip refresh and address counters.
12. I_{DD} specifications are tested after the device is properly initialized.
13. This parameter is sampled. $V_{DD} = +2.5V/+2.65V +0.1V/-0.1V$, $V_{DDQ} = +2.5V/+2.65V +0.1V -0.1$, $V_{REF} = V_{SS}$, $f = 100$ MHz, $T_A = 25^\circ C$, $V_{OUT(DC)} = V_{DDQ}/2$, V_{OUT} (peak to peak) = 0.2V. DM input is grouped with I/O pins, reflecting the fact that they are matched in loading.
14. Command/Address input slew rate = 0.5V/ns. For slew rates 1V/ns or faster, t_{IS} and t_{IH} are reduced to 900ps. If the slew rate is less than 0.5V/ns, timing must be derated: t_{IS} has an additional 100ps per 100mV/ns reduction in slew rate from 500mV/ns. If the slew rate exceeds 4.5V/ns, functionality is uncertain.
15. The CK/CK# input reference level (for timing referenced to CK/CK#) is the point at which CK and CK# cross; the input reference level for signals other than CK/CK# is V_{REF} .
16. Inputs are not recognized as valid until V_{REF} stabilizes. Exception: during the period before V_{REF} stabilizes, $CKE \leq 0.3 \times V_{DDQ}$ is recognized as LOW.
17. The output timing reference level, as measured at the timing reference point indicated in Note 3, is V_{TT} .
18. tHZ and tLZ transitions occur in the same access time windows as valid data transitions. These parameters are not referenced to a specific voltage level, but specify when the device output is no longer driving (HZ) or begins driving (LZ).
19. The maximum limit for this parameter is not a device limit. The device will operate with a greater value for this parameter, but system performance (bus turnaround) will degrade accordingly.
20. This is not a device limit. The device will operate with a negative value, but system performance could be degraded due to bus turnaround.
21. It is recommended that DQS be valid (HIGH or LOW) on or before the WRITE command. The case shown (DQS going from High-Z to logic LOW) applies when no WRITES were previously in progress on the bus. If a previous WRITE was in progress, DQS could be HIGH during this time, depending on tDQSS .
22. MIN (tRC or tRFC) for I_{DD} measurements is the smallest multiple of tCK that meets the minimum absolute value for the respective parameter. tRAS (MAX) for I_{DD} measurements is the largest multiple of tCK that meets the maximum absolute value for tRAS .

NOTES (continued)

23. The refresh period 32ms. This equates to an average refresh rate of 7.8 μ s. However, an AUTO REFRESH command must be asserted at least once every 70.2 μ s; burst refreshing or posting by the DRAM controller greater than eight refresh cycles is not allowed.
24. The I/O capacitance per DQS and DQ byte/group will not differ by more than this maximum amount for any given device.
25. The valid data window is derived by achieving other specifications — t_{HP} ($t_{CK}/2$), t_{DQSQ} , and t_{QH} [$t_{HP} - 0.5ns$ (-5), $t_{HP} - 0.55ns$ (-55), $t_{HP} - 0.6ns$ (-6) or $t_{HP} - 0.65ns$ (-65)]. The data valid window derates directly proportional with the clock duty cycle and a practical data valid window can be derived. The clock is allowed a maximum duty cycle variation of 45/55. Functionality is uncertain when operating beyond a 45/55 ratio. The data valid window derating curves are provided below for duty cycles ranging between 50/50 and 45/55.
26. Referenced to each output group: DQS with DQ0-DQ31
27. This limit is actually a nominal value and does not result in a fail value. CKE is HIGH during REFRESH command period (t_{RFC} [MIN]) else CKE is LOW (i.e., during standby).
28. To maintain a valid level, the transitioning edge of the input must:
 - a) Sustain a constant slew rate from the current AC level through to the target AC level, $V_{IL(AC)}$ or $V_{IH(AC)}$.
 - b) Reach at least the target AC level.
 - c) After the AC target level is reached, continue to maintain at least the target DC level, $V_{IL(DC)}$ or $V_{IH(DC)}$.
29. The Input capacitance per pin group will not differ by more than this maximum amount for any given device..
30. CK and CK# input slew rate must be $\geq 1V/ns$.
31. DQ and DM input slew rates must not deviate from DQS by more than 10%. If the DQ/DM/DQS slew rate is less than 0.5V/ns, timing is no longer referenced to the mid-point but to the $V_{IL(AC)}$ maximum and $V_{IH(DC)}$ minimum points.
32. V_{DD} must not vary more than 4% if CKE is not active while any bank is active.

**DERATING DATA VALID WINDOW
($t_{QH} - t_{DQSQ}$) at CL = 3**

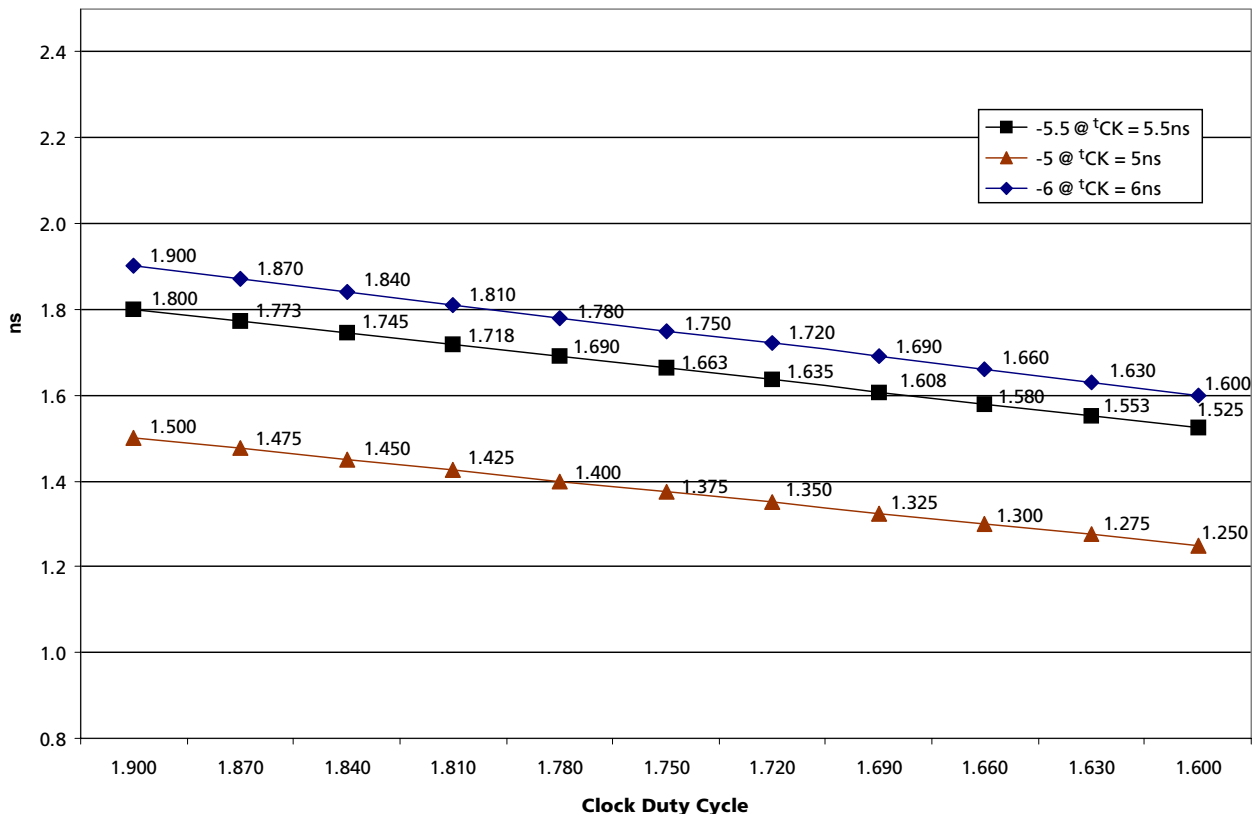

NOTES (continued)

33. The clock is allowed up to ± 175 ps of clock to clock jitter with a ± 80 ps cumulative jitter. Each AC timing parameter is also allowed to vary by the same amount.
34. t_{HP} (MIN) is the lesser of t_{CL} minimum and t_{CH} minimum actually applied to the device CK and CK/ inputs, collectively during bank active.
35. READs and WRITEs with autoprecharge are not allowed to be issued until t_{RAS} (MIN) can be satisfied prior to the internal precharge command being issued.
36. Impedance match output drive curves:
 - a) The full variation in driver pull-down current from minimum to maximum process, temperature and voltage will lie within the outer bounding lines of the V-I curve of Figures A and B.
 - b) The variation in driver pull-down current within nominal limits of voltage and temperature is expected, but not guaranteed, to lie within the inner bounding lines of the V-I curve of Figures A and B.
 - c) The full variation in driver pull-up current from minimum to maximum process, temperature and voltage will lie within the outer bounding lines of the V-I curve of Figures C and D.
 - d) The variation in driver pull-up current within nominal limits of voltage and temperature is expected, but not guaranteed, to lie within the inner bounding lines of the V-I curve of Figures C and D.
 - e) The full variation in the ratio of the maximum to minimum pull-up and pull-down current will not exceed 1.7, for device drain-to-source voltages from 0 to $V_{DDQ}/2$.
 - f) The full variation in the ratio of the nominal pull-up to pull-down current should be unity $\pm 30\%$, for device drain-to-source voltages from 0 to $V_{DDQ}/2$.

NOTES (continued)
37. Reduced Output Drive Curves:

- a) The full variation in driver pull-down current from minimum to maximum process, temperature and voltage will lie within the outer bounding lines of the V-I curve of Figures E and F.
- b) The variation in driver pull-down current within nominal limits of voltage and temperature is expected, but not guaranteed, to lie within the inner bounding lines of the V-I curve of Figures E and F.
- c) The full variation in driver pull-up current from minimum to maximum process, temperature and voltage will lie within the outer bounding lines of the V-I curve of Figures G and H.
- d) The variation in driver pull-up current within nominal limits of voltage and temperature is expected, but not guaranteed, to lie within the inner bounding lines of the V-I curve of Figures G and H.

- e) The full variation in the ratio of the maximum to minimum pull-up and pull-down current will not exceed 1.7, for device drain-to-source voltages from 0 to $V_{DDQ}/2$.
 - f) The full variation in the ratio of the nominal pull-up to pull-down current should be unity $\pm 10\%$, for device drain-to-source voltages from 0 to 0.1V to 1.0V.
38. The voltage levels used are derived from the referenced test load. In practice, the voltage levels obtained from a properly terminated bus will provide significantly different voltage values.
 39. V_{IH} overshoot: $V_{IH} (MAX) = V_{DDQ} + 1.5V$ for a pulse width $\leq 3ns$ and the pulse width can not be greater than 1/3 of the cycle rate. V_{IL} undershoot: $V_{IL} (MIN) = -1.5V$ for a pulse width $\leq 3ns$ and the pulse width can not be greater than 1/3 of the cycle rate.
 40. CKE must be active (high) during the entire time a refresh command is executed. That is, from the time the AUTO REFRESH command is registered, CKE must be active at each rising clock edge, until t_{REF} later.
 41. Whenever the operating frequency is altered, not including jitter, the DLL is required to be reset and followed by a 200 clock cycle delay.
 42. V_{DD} and V_{DDQ} must track each other.
 43. Will slightly adjust with V_{DD}/V_{DDQ} level.
 44. During initialization, V_{DDQ} , V_{TT} , and V_{REF} must be equal to or less than $V_{DD} + 0.3V$. Alternatively, V_{TT} may be 1.35V maximum during power up, even if V_{DD}/V_{DDQ} are 0 volts, provided a minimum of 42 ohms or series resistance is used between the V_{TT} supply and the input pin.
 45. $t_{RCD} \leq t_{RAP}$

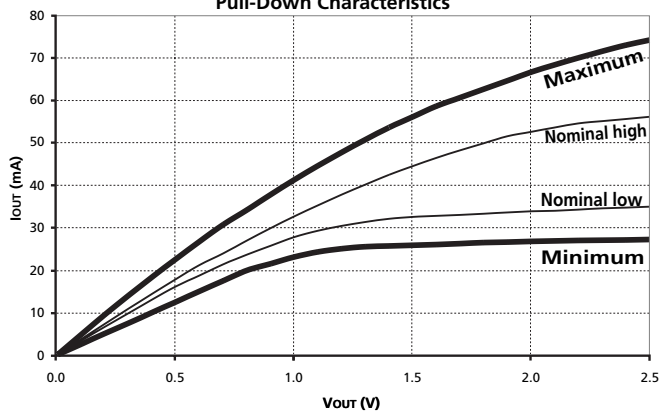
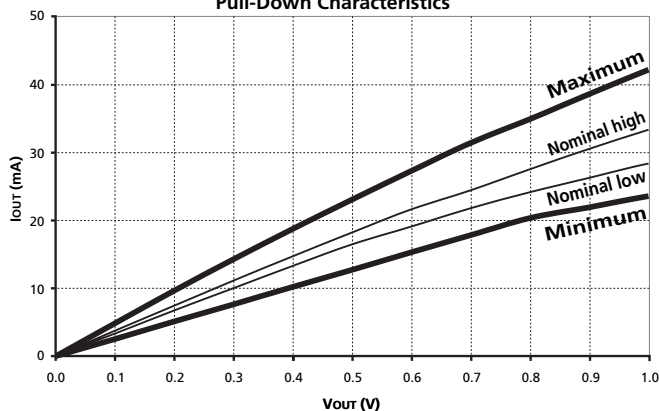
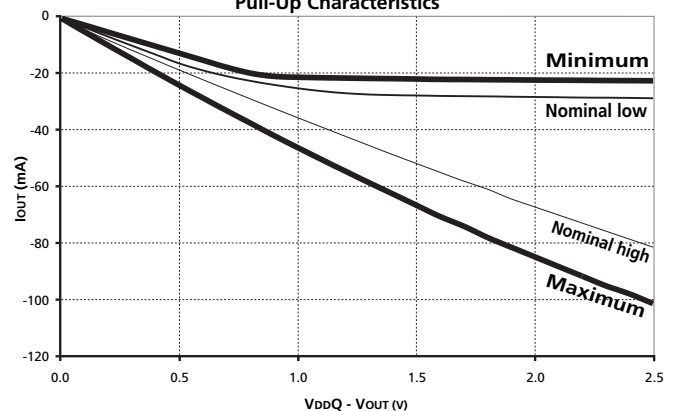
**Figure E
Pull-Down Characteristics**

**Figure F
Pull-Down Characteristics**

**Figure G
Pull-Up Characteristics**

IMPEDANCE-MATCHED OUTPUT DRIVE CHARACTERISTICS

VOLTAGE (V)	PULL-DOWN CURRENT (mA)				PULL-UP CURRENT (mA)			
	NOMINAL LOW	NOMINAL HIGH	MINIMUM	MAXIMUM	NOMINAL LOW	NOMINAL HIGH	MINIMUM	MAXIMUM
0.1	— TBD —							
0.2								
0.3								
0.4								
0.5								
0.6								
0.7								
0.8								
0.9								
1.0								
1.1								
1.2								
1.3								
1.4								
1.5								
1.6								
1.7								
1.8								
1.9								
2.0								
2.1								
2.2								
2.3								
2.4								
2.5								

NOTE: The above characteristics are specified under best, worst, and nominal process variation/conditions.

REDUCED OUTPUT DRIVE CHARACTERISTICS

VOLTAGE (V)	PULL-DOWN CURRENT (mA)				PULL-UP CURRENT (mA)			
	NOMINAL LOW	NOMINAL HIGH	MINIMUM	MAXIMUM	NOMINAL LOW	NOMINAL HIGH	MINIMUM	MAXIMUM
0.1	3.3	3.7	2.5	4.8	-3.3	-4.1	-2.5	-4.9
0.2	6.6	7.3	5.0	9.4	-6.6	-7.8	-5.0	-9.7
0.3	9.8	10.9	7.4	14.0	-9.8	-11.4	-7.4	-14.5
0.4	13.0	14.4	10.0	18.3	-12.9	-14.9	-10.0	-19.2
0.5	16.1	17.8	12.4	22.6	-16.1	-18.4	-12.4	-23.9
0.6	18.7	21.1	14.9	26.7	-18.5	-21.9	-14.9	-28.4
0.7	21.3	23.9	17.4	30.7	-20.5	-25.3	-17.4	-32.9
0.8	23.6	26.9	19.9	34.1	-22.2	-28.7	-19.5	-37.3
0.9	25.6	29.8	21.4	37.7	-23.6	-32.1	-20.6	-41.7
1.0	27.7	32.6	23.0	41.2	-24.8	-35.4	-20.9	-46.0
1.1	29.2	35.2	24.2	44.5	-25.8	-38.6	-21.1	-50.2
1.2	30.3	37.7	25.0	47.7	-26.6	-41.9	-21.2	-54.3
1.3	31.3	40.1	25.4	50.7	-27.0	-45.2	-21.3	-58.4
1.4	32.0	42.4	25.6	53.5	-27.2	-48.4	-21.4	-62.4
1.5	32.5	44.4	25.8	56.0	-27.4	-51.6	-21.5	-66.4
1.6	32.7	46.4	25.9	58.6	-27.5	-54.7	-21.6	-70.4
1.7	32.9	48.1	26.2	60.6	-27.6	-57.8	-21.7	-73.8
1.8	33.2	49.8	26.4	62.6	-27.7	-60.7	-21.8	-77.8
1.9	33.5	51.5	26.5	64.6	-27.8	-64.1	-21.8	-81.3
2.0	33.8	52.5	26.7	66.6	-27.9	-67.0	-21.9	-84.7
2.1	33.9	53.5	26.8	68.3	-28.0	-69.8	-21.9	-88.1
2.2	34.2	54.5	26.9	69.9	-28.1	-72.7	-22.0	-91.6
2.3	34.5	55.0	27.0	71.5	-28.2	-75.6	-22.0	-95.0
2.4	34.6	55.5	27.0	72.9	-28.2	-78.4	-22.1	-97.9
2.5	34.9	56.0	27.1	74.1	-28.3	-81.3	-22.2	-101.3

NOTE: The above characteristics are specified under best, worst, and nominal process variation/conditions.

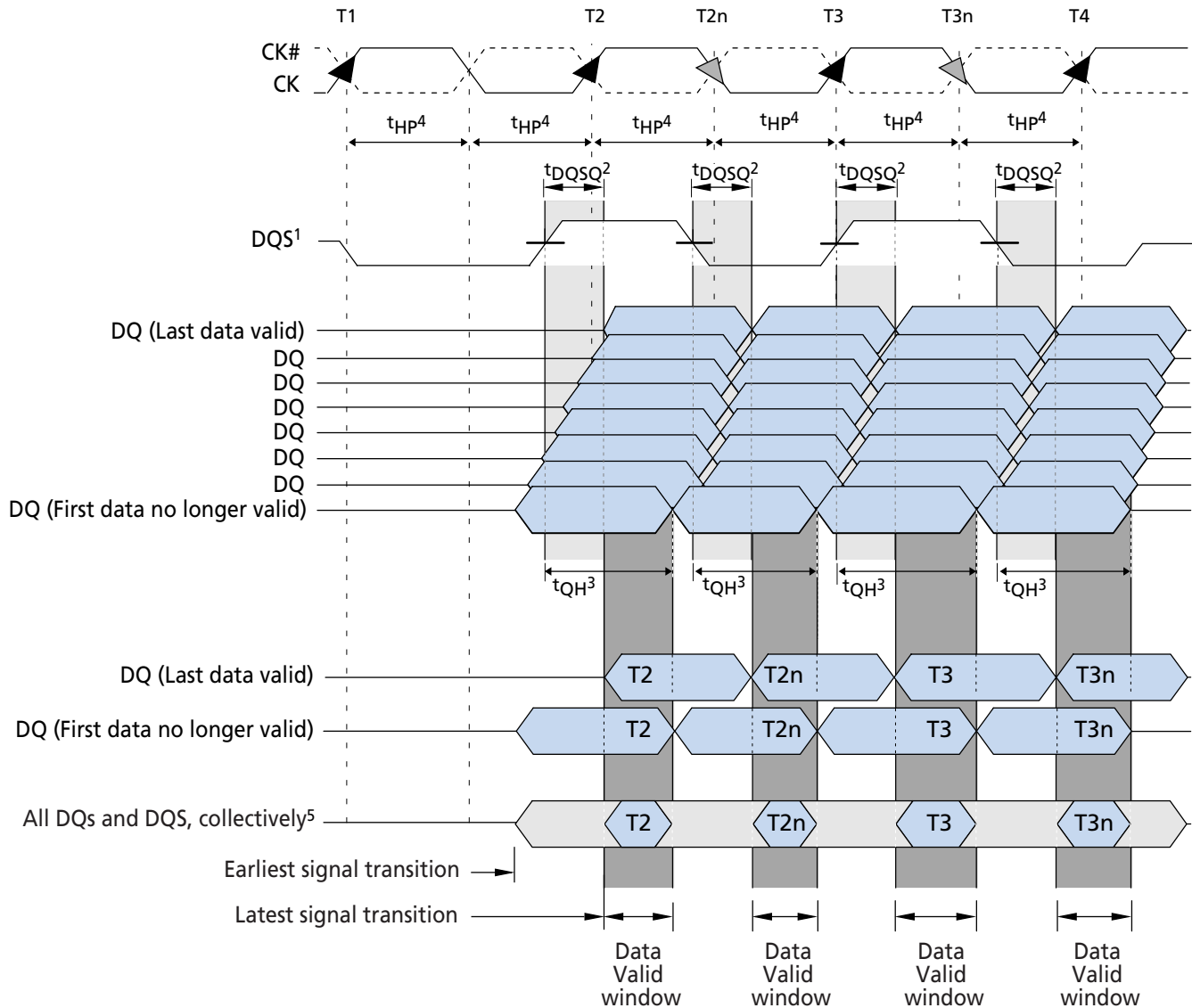

- NOTE:**
1. DQs transitioning after DQS transition define t_{DQSQ} window. DQS transitions at T2 and at T2n are an early DQS, at T3 is a nominal DQS, and at T3n is a late DQS.
 2. t_{DQSQ} is derived at each DQS clock edge and is not cumulative over time and begins with DQS transition and ends with the last valid transition of DQs.
 3. t_{QH} is derived from t_{HP} : $t_{QH} = t_{HP}$
 4. t_{HP} is the lesser of t_{CL} or t_{CH} clock transition collectively when a bank is active.
 5. The data valid window is derived for each DQS transitions and is defined as t_{QH} minus t_{DQSQ} .

**Figure 28
Data Output Timing – t_{DQSQ} , t_{QH} , and Data Valid Window**

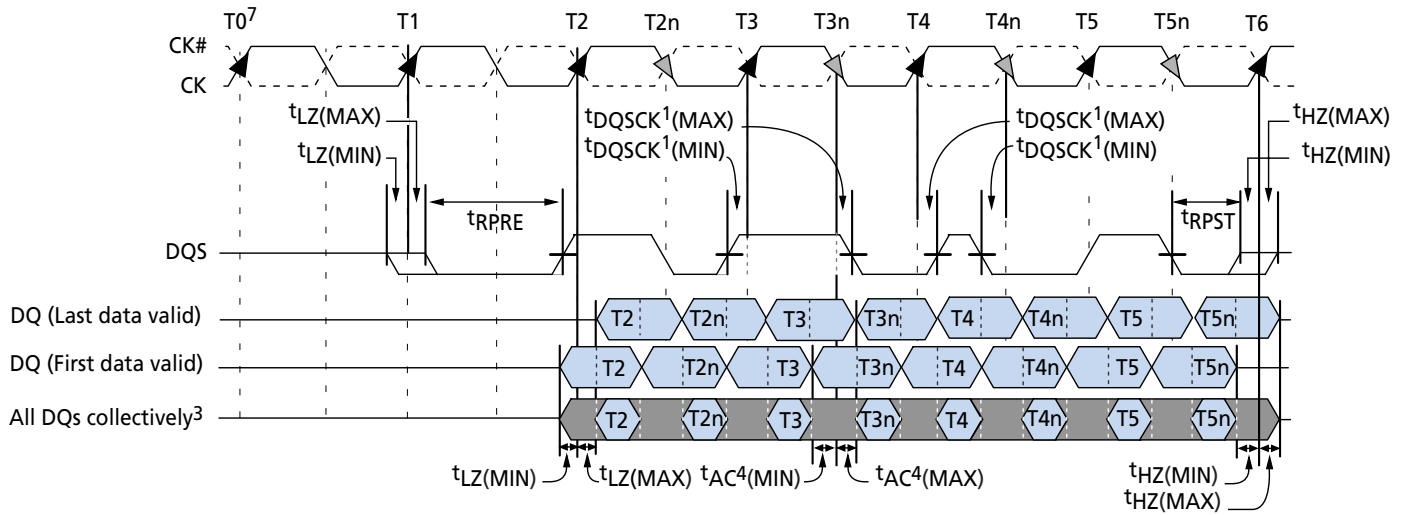

- NOTE:**
- t_{DQSK}^1 is the DQS output window relative to CK and is the "long term" component of DQS skew.
 - DQs transitioning after DQS transition define t_{DQSQ} window.
 - All DQs must transition by t_{DQSQ} after DQS transitions, regardless of t_{AC} .
 - t_{AC} is the DQ output window relative to CK, and is the "long term" component of DQ skew.
 - $t_{LZ(MIN)}$, $t_{AC(MIN)}$ and $t_{HZ(MIN)}$ are the first valid signal transition.
 - $t_{LZ(MAX)}$, $t_{AC(MAX)}$ and $t_{HZ(MAX)}$ are the latest valid signal transition.
 - READ command with CL = 2 issued at T0.

Figure 29
Data Output Timing – t_{AC} and t_{DQSK}^1

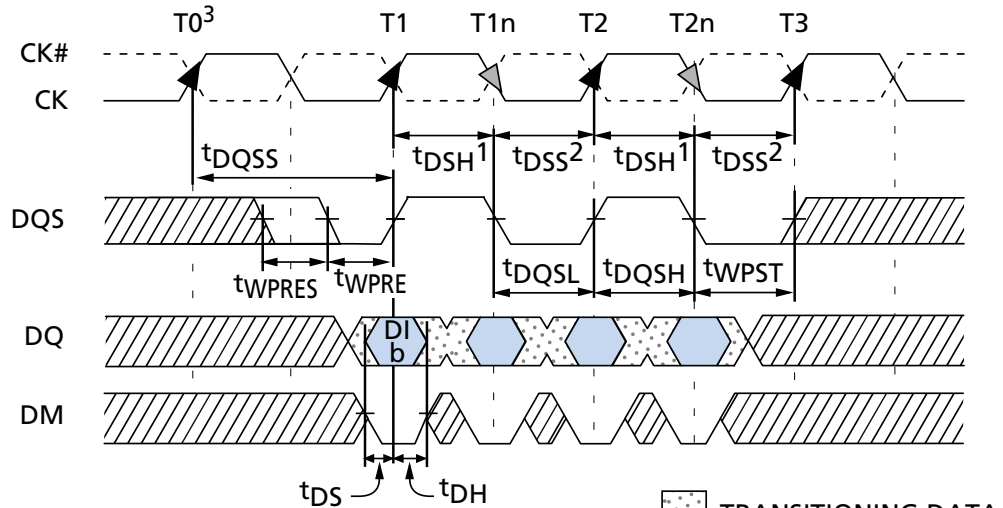

- NOTE:**
- $t_{DSH(MIN)}$ generally occurs during $t_{DQSS(MIN)}$.
 - $t_{DSS(MIN)}$ generally occurs during $t_{DQSS(MAX)}$.
 - WRITE command issued at T0.

TRANSITIONING DATA
 DON'T CARE

Figure 30
Data Input Timing

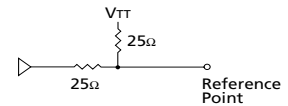
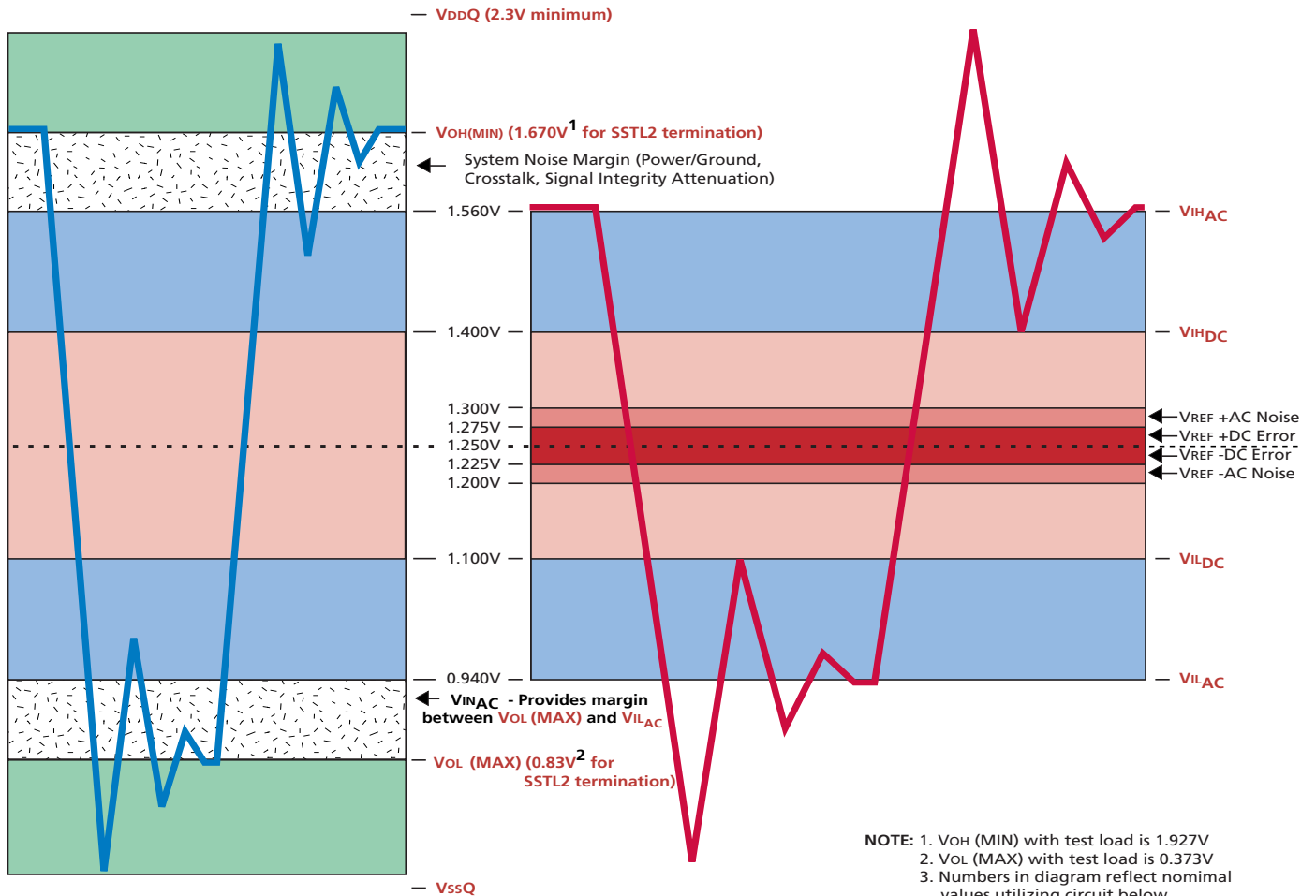
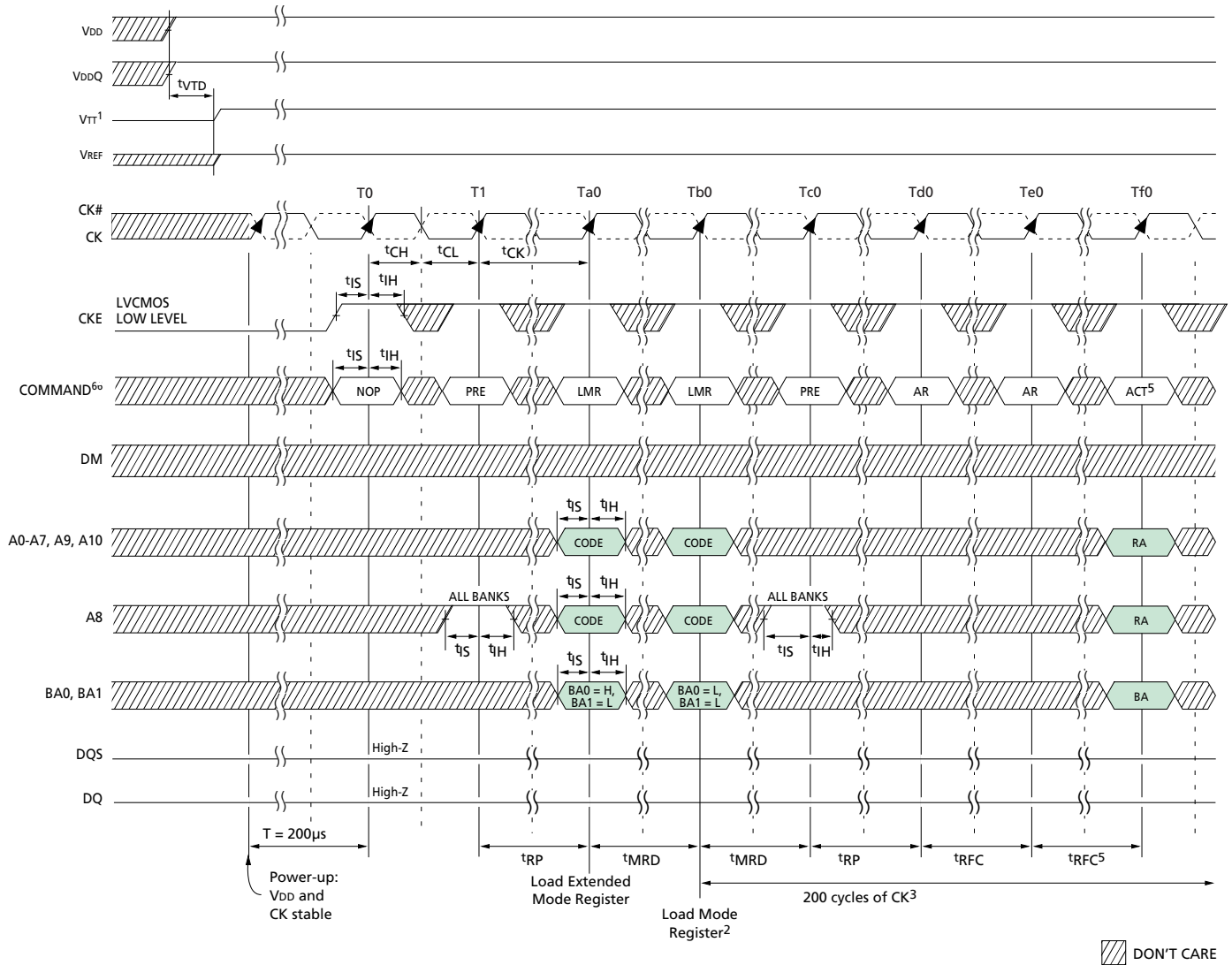

Figure 31
Input Voltage Waveform

INITIALIZE AND LOAD MODE REGISTERS



- NOTE:**
1. V_{TT1} is not applied directly to the device; however, t_{VTD} must be greater than or equal to zero to avoid device latch-up.
 2. JEDEC specifies resetting the DLL with $A8 = H$.
 3. t_{MRD} is required before any command can be applied, and 200 cycles of CK are required before a READ command can be issued.
 4. The two AUTO REFRESH commands at $Tc0$ and $Td0$ may be applied after the LOAD MODE REGISTER (LMR) command at $Ta0$.
 5. Although not required by the Micron device, JEDEC specifies issuing another LMR command ($A8 = L$) prior to activating any bank.
 6. PRE = PRECHARGE command, LMR = LOAD MODE REGISTER command, AR = AUTO REFRESH command, ACT = ACTIVE command, RA = Row Address, BA = Bank Address

TIMING PARAMETERS

SYMBOL	-5		-6		-65		UNITS
	MIN	MAX	MIN	MAX	MIN	MAX	
t_{CH}	0.45	0.55	0.45	0.55	0.45	0.55	t_{CK}
t_{CL}	0.45	0.55	0.45	0.55	0.45	0.55	t_{CK}
$t_{CK(3)}$	5	12	6	12	6.5	12	ns
$t_{CK(2)}$	8	12	10	12	10	12	ns
t_{IH}	1		1		1		ns

SYMBOL	-5		-6		-65		UNITS
	MIN	MAX	MIN	MAX	MIN	MAX	
t_{JS}	1		1		1		ns
t_{MRD}	2		2		2		t_{CK}
t_{RFC}	66		66		66		ns
t_{RP}	20		18		19.5		ns
t_{VTD}	0		0		0		ns

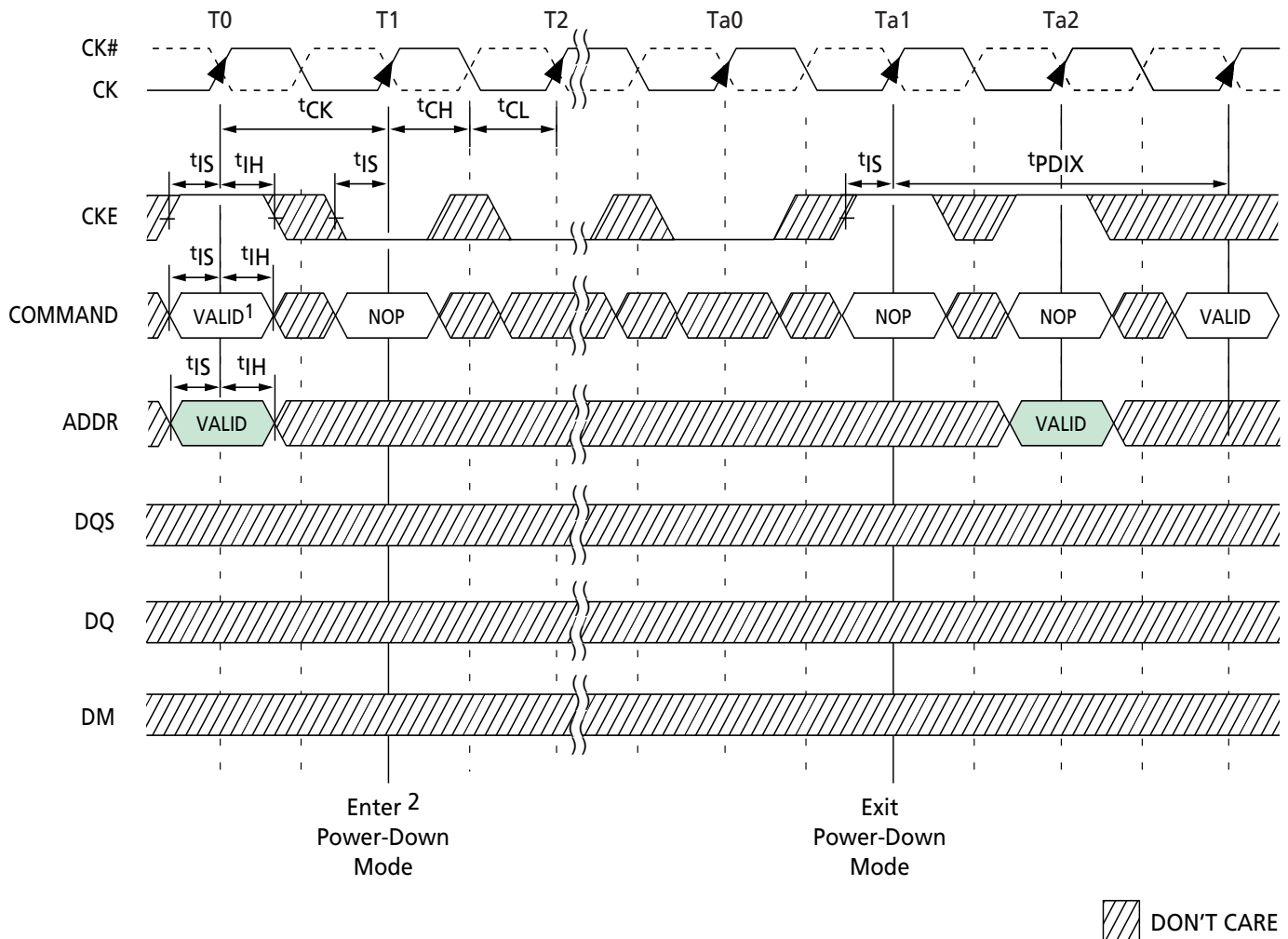
POWER-DOWN MODE

- NOTE:** 1. If this command is a PRECHARGE (or if the device is already in the idle state), then the power-down mode shown is precharge power-down. If this command is an ACTIVE (or if at least one row is already active), then the power-down mode shown is active power-down.
2. No column accesses are allowed to be in progress at the time power-down is entered.

TIMING PARAMETERS

SYMBOL	-5		-6		-65		UNITS
	MIN	MAX	MIN	MAX	MIN	MAX	
t_{CH}	0.45	0.55	0.45	0.55	0.45	0.55	t_{CK}
t_{CL}	0.45	0.55	0.45	0.55	0.45	0.55	t_{CK}
$t_{CK}(3)$	5	12	6	12	6.5	12	ns

SYMBOL	-5		-6		-65		UNITS
	MIN	MAX	MIN	MAX	MIN	MAX	
$t_{CK}(2)$	8	12	10	12	10	12	ns
t_{IH}	1		1		1		ns
t_{IS}	1		1		1		ns

AUTO REFRESH MODE

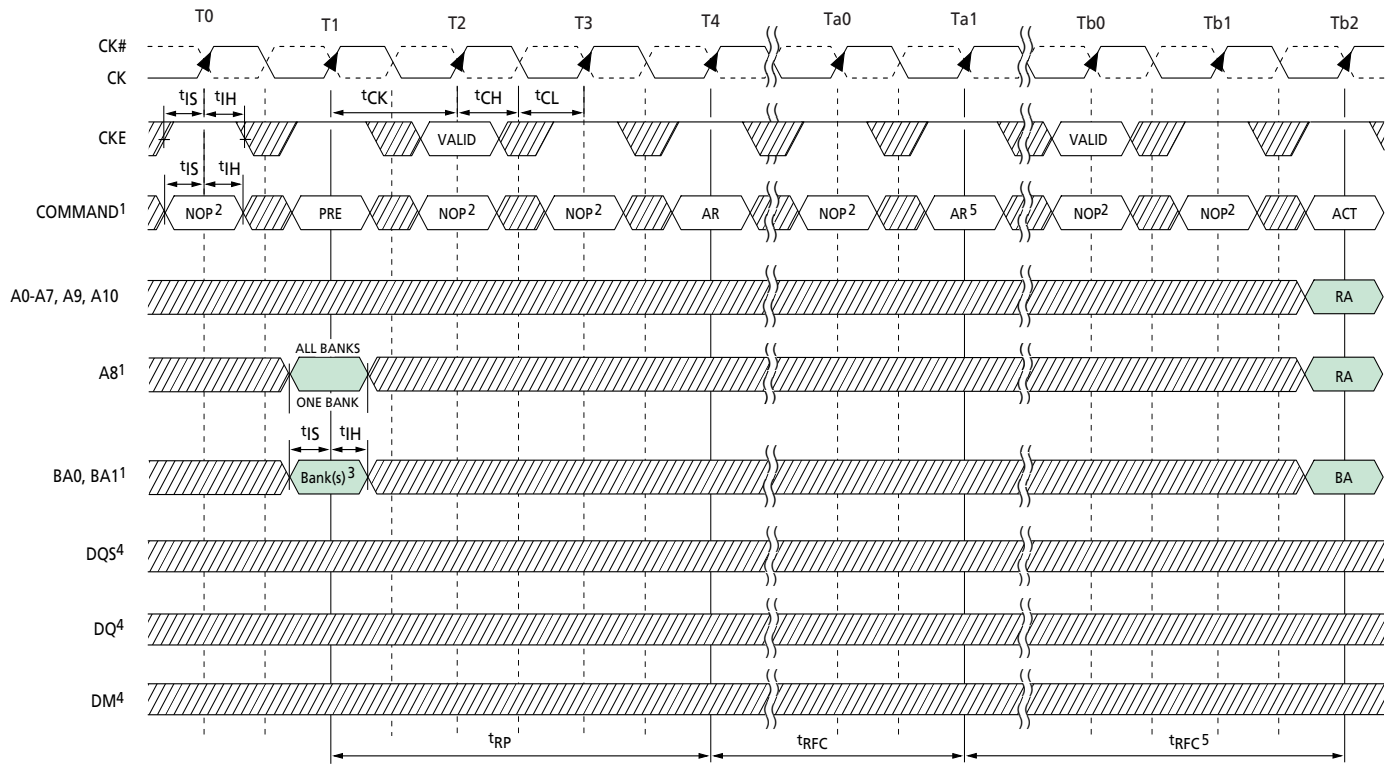

DON'T CARE

- NOTE:**
1. PRE = PRECHARGE, ACT = ACTIVE, AR = AUTO REFRESH, RA = Row Address, BA = Bank Address.
 2. NOP commands are shown for ease of illustration; other valid commands may be possible at these times.
 3. "Don't Care" if A8 is HIGH at this point; A10 must be HIGH if more than one bank is active (i.e., must precharge all active banks).
 4. DM, DQ, and DQS signals are all "Don't Care"/High-Z for operations shown.
 5. The second AUTO REFRESH is not required and is only shown as an example of two back-to-back AUTO REFRESH commands.

TIMING PARAMETERS

SYMBOL	-5		-6		-65		UNITS
	MIN	MAX	MIN	MAX	MIN	MAX	
t_{CH}	0.45	0.55	0.45	0.55	0.45	0.55	t_{CK}
t_{CL}	0.45	0.55	0.45	0.55	0.45	0.55	t_{CK}
$t_{CK}(3)$	5	12	6	12	6.5	12	ns
$t_{CK}(2)$	8	12	10	12	10	12	ns

SYMBOL	-5		-6		-65		UNITS
	MIN	MAX	MIN	MAX	MIN	MAX	
t_{IH}	1		1		1		ns
t_{IS}	1		1		1		ns
t_{RFC}	66		66		66		ns
t_{RP}	20		18		19.5		ns

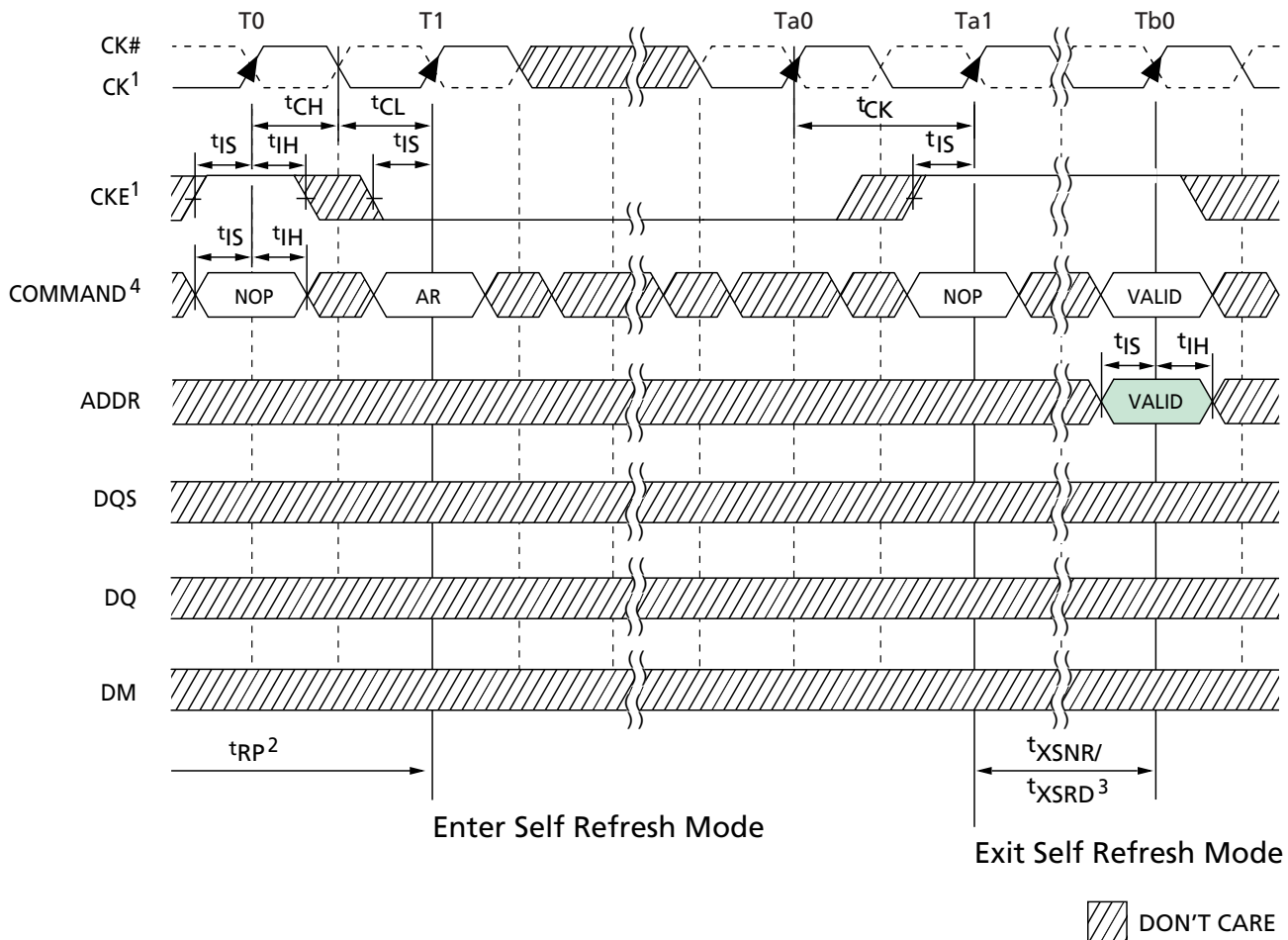
SELF REFRESH MODE

- NOTE:**
1. Clock must be stable before exiting self refresh mode.
 2. Device must be in the all banks idle state prior to entering self refresh mode.
 3. t_{XSNR} is required before any non-READ command can be applied, and t_{XSRD} (200 cycles of CK) is required before a READ command can be applied.
 4. AR = AUTO REFRESH command.

TIMING PARAMETERS

SYMBOL	-5		-6		-65		UNITS
	MIN	MAX	MIN	MAX	MIN	MAX	
t_{CH}	0.45	0.55	0.45	0.55	0.45	0.55	t_{CK}
t_{CL}	0.45	0.55	0.45	0.55	0.45	0.55	t_{CK}
$t_{CK} (3)$	5	12	6	12	6.5	12	ns
$t_{CK} (2)$	8	12	10	12	10	12	ns
t_{IH}	1		1		1		ns

SYMBOL	-5		-6		-65		UNITS
	MIN	MAX	MIN	MAX	MIN	MAX	
t_{IS}	1		1		1		ns
t_{RP}	20		18		19.5		ns
t_{XSNR}	65		66		66		ns
t_{XSRD}	200		200		200		t_{CK}

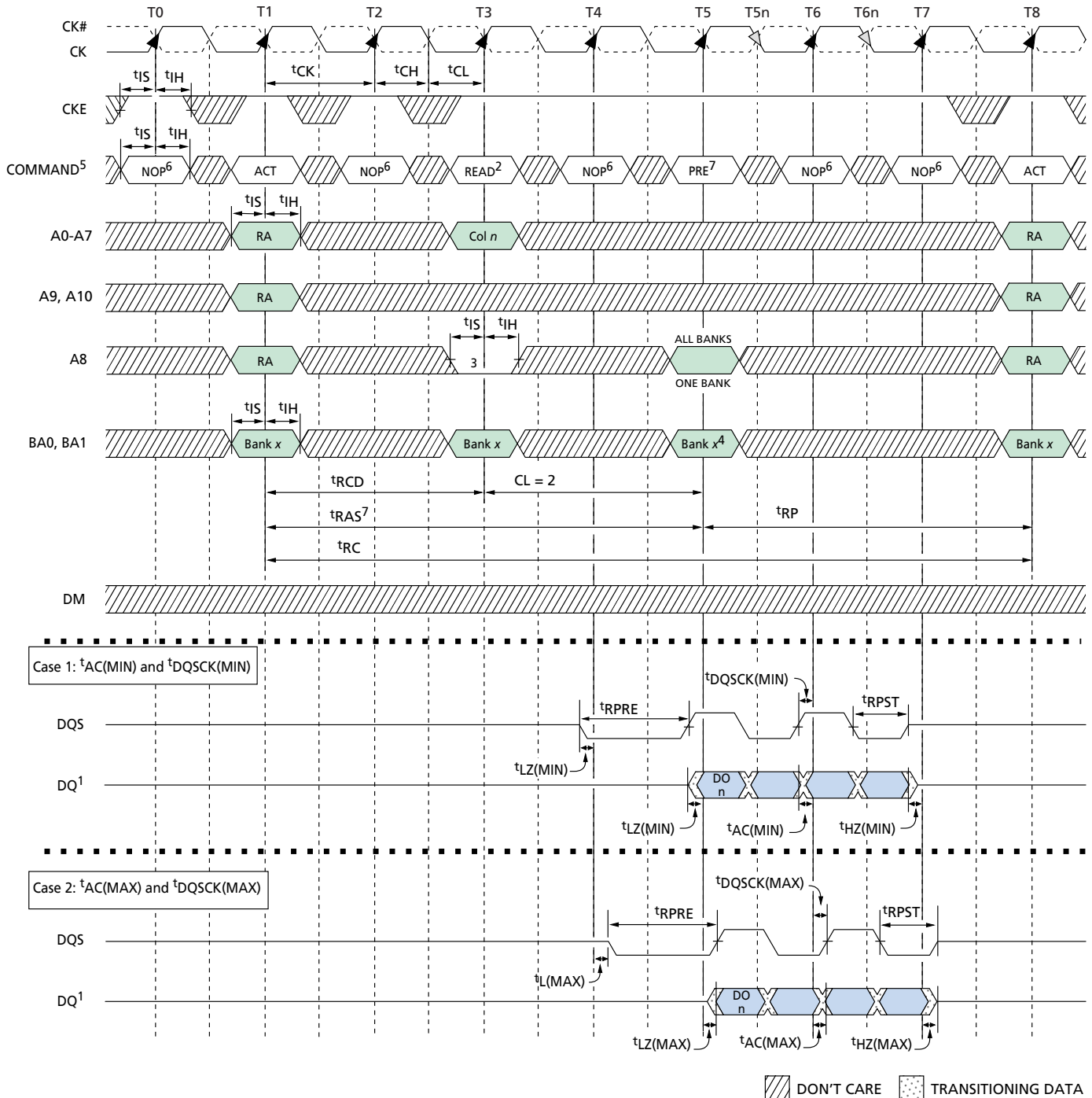
BANK READ – WITHOUT AUTO PRECHARGE

- NOTE:** 1. DO_n = data-out from column n ; subsequent elements are provided in the programmed order.
 2. Burst length = 4 in the case shown.
 3. Disable auto precharge.
 4. "Don't Care" if A8 is HIGH at T5.
 5. PRE = PRECHARGE, ACT = ACTIVE, RA = Row Address, BA = Bank Address.
 6. NOP commands are shown for ease of illustration; other commands may be valid at these times.
 7. The PRECHARGE command can only be applied at T5 if $t_{RAS}(\text{MIN})$ is met.

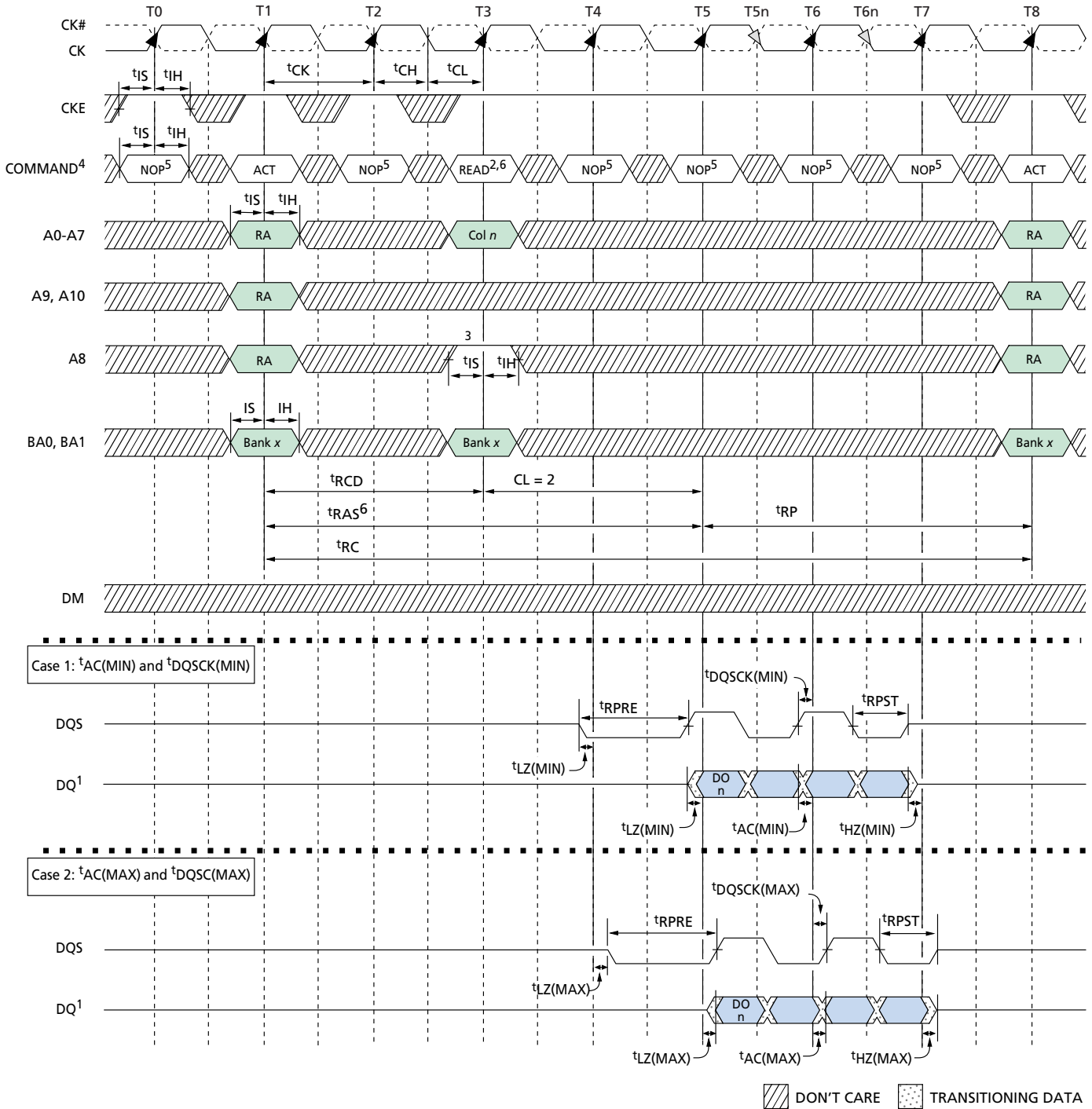
BANK READ – WITH AUTO PRECHARGE

- NOTE:**
1. DO_n = data-out from column n ; subsequent elements are provided in the programmed order.
 2. Burst length = 4 in the case shown.
 3. Enable auto precharge.
 4. ACT = ACTIVE, RA = Row Address, BA = Bank Address.
 5. NOP commands are shown for ease of illustration; other commands may be valid at these times.
 6. The READ command can only be applied at T3 if $t_{RAS}(\text{MIN})$ is met by T5.

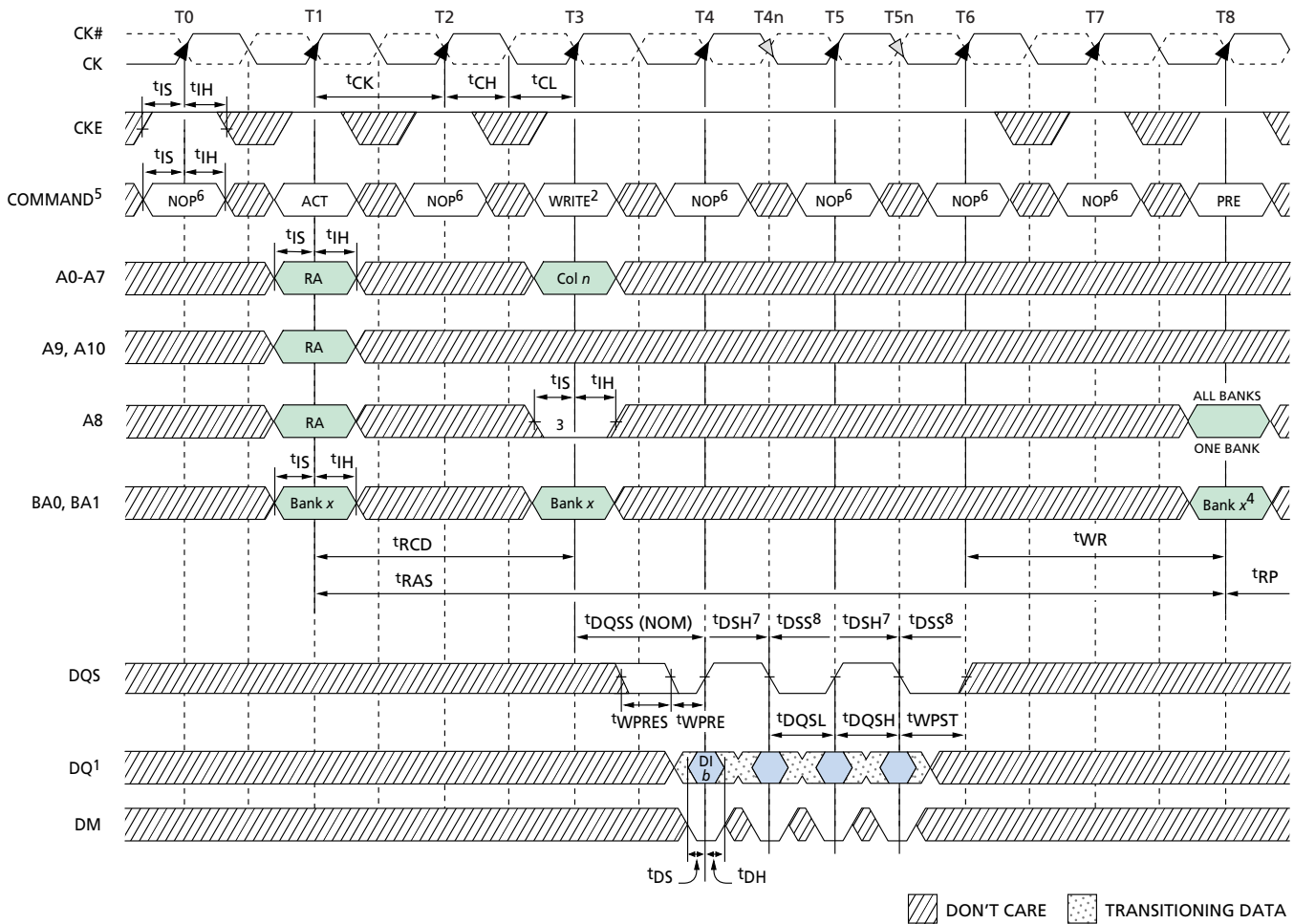
BANK WRITE – WITHOUT AUTO PRECHARGE

- NOTE:** 1. $DI\ n$ = data-out from column n ; subsequent elements are provided in the programmed order.
 2. Burst length = 4 in the case shown.
 3. Disable auto precharge.
 4. "Don't Care" if A8 is HIGH at T8.
 5. PRE = PRECHARGE, ACT = ACTIVE, RA = Row Address, BA = Bank Address.
 6. NOP commands are shown for ease of illustration; other commands may be valid at these times.
 7. t_{DSH} is applicable during t_{DQSS} (MIN) and is referenced from CK T4 or T5.
 8. t_{DSS} is applicable during t_{DQSS} (MAX) and is referenced from CK T5 or T6.

TIMING PARAMETERS

SYMBOL	-5		-6		-65		UNITS
	MIN	MAX	MIN	MAX	MIN	MAX	
t_{CH}	0.45	0.55	0.45	0.55	0.45	0.55	t_{CK}
t_{CL}	0.45	0.55	0.45	0.55	0.45	0.55	t_{CK}
t_{CK} (3)	5	12	6	12	6.5	12	ns
t_{CK} (2)	8	12	9	12	10	12	ns
t_{DH}	0.6		0.6		0.6		ns
t_{DS}	0.6		0.6		0.6		ns
t_{DQSH}	0.4		0.4		0.4		t_{CK}
t_{DQSL}	0.4		0.4		0.4		t_{CK}
t_{DQSS}	0.75	1.25	0.75	1.25	0.75	1.25	t_{CK}
t_{DSS}	0.25		0.25		0.25		t_{CK}

SYMBOL	-5		-6		-65		UNITS
	MIN	MAX	MIN	MAX	MIN	MAX	
t_{DSH}	0.25		0.25		0.25		t_{CK}
t_{IH}	1		1		1		ns
t_{IS}	1		1		1		ns
t_{RAS}	40	120,000	40	120,000	40	120,000	ns
t_{RCD}	20		18		19.5		ns
t_{RP}	20		18		19.5		ns
t_{WPRE}	0.25		0.25		0.25		t_{CK}
t_{WPRES}	0		0	0	0	0	ns
t_{WPST}	0.4	0.6	0.4	0.6	0.4	0.6	t_{CK}
t_{WR}	2		2		2		t_{CK}

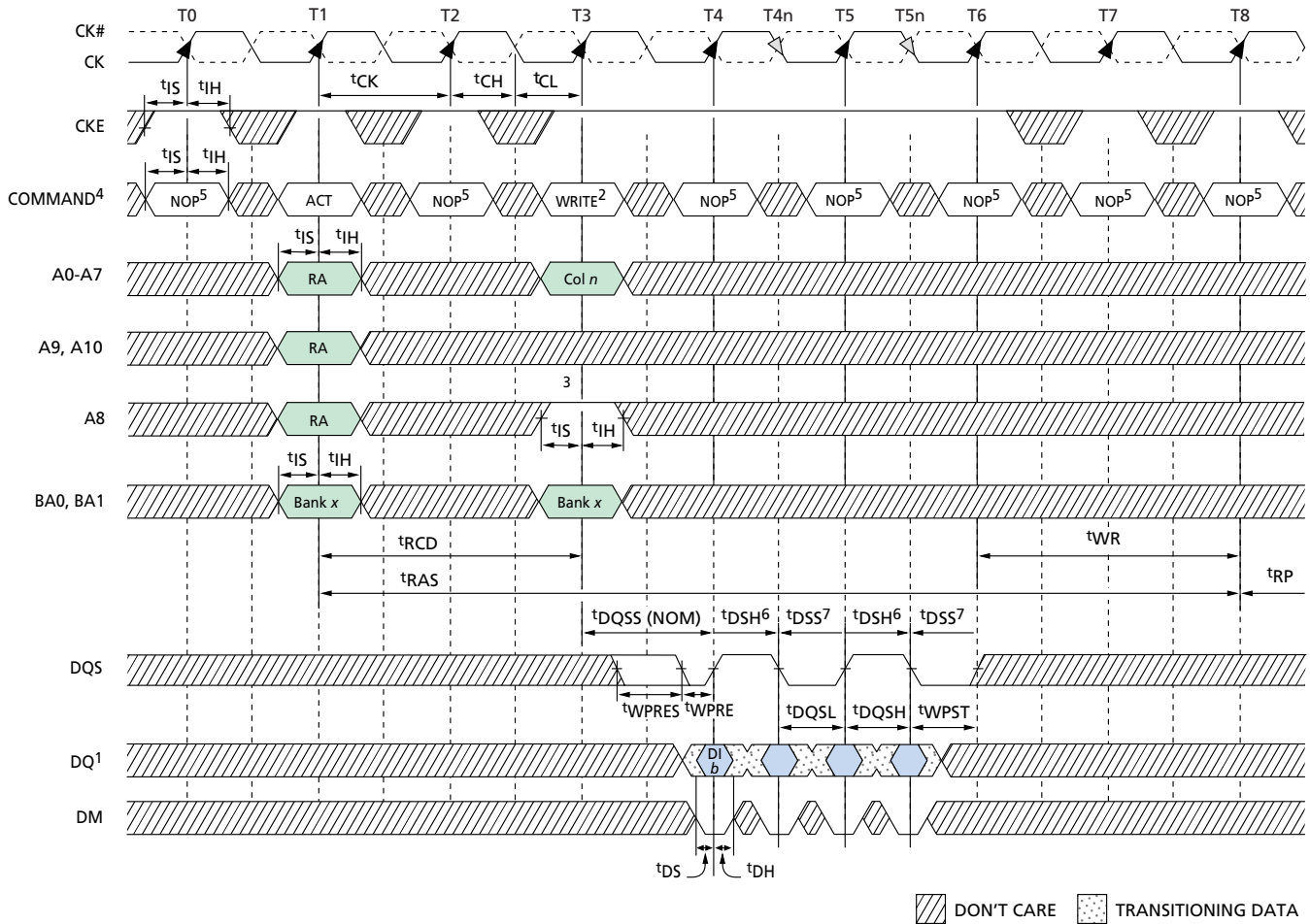
BANK WRITE – WITH AUTO PRECHARGE

- NOTE:** 1. DI n = data-out from column n ; subsequent elements are provided in the programmed order.
 2. Burst length = 4 in the case shown.
 3. Enable auto precharge.
 4. ACT = ACTIVE, RA = Row Address, BA = Bank Address.
 5. NOP commands are shown for ease of illustration; other commands may be valid at these times.
 6. tDSH is applicable during tDQSS(MIN) and is referenced from CK T4 or T5.
 7. tDSS is applicable during tDQSS (MAX) and is referenced from CK T5 or T6.

TIMING PARAMETERS

SYMBOL	-5		-6		-65		UNITS
	MIN	MAX	MIN	MAX	MIN	MAX	
tCH	0.45	0.55	0.45	0.55	0.45	0.55	tCK
tCL	0.45	0.55	0.45	0.55	0.45	0.55	tCK
tCK (3)	5	12	6	12	6.5	12	ns
tCK (2)	8	12	9	12	10	12	ns
tDH	0.6		0.6		0.6		ns
tDS	0.6		0.6		0.6		ns
tDQSH	0.4		0.4		0.4		tCK
tDQSL	0.4		0.4		0.4		tCK
tDQSS	0.75	1.25	0.75	1.25	0.75	1.25	tCK
tDSS	0.25		0.25		0.25		tCK

SYMBOL	-5		-6		-65		UNITS
	MIN	MAX	MIN	MAX	MIN	MAX	
tDSH	0.25		0.25		0.25		tCK
tIH	1		1		1		ns
tIS	1		1		1		ns
tRAS	40	120,000	40	120,000	40	120,000	ns
tRCD	20		18		19.5		ns
tRP	20		18		19.5		ns
tWPRE	0.25		0.25		0.25		tCK
tWPRES	0		0		0		ns
tWPST	0.4	0.6	0.4	0.6	0.4	0.6	tCK
tWR	2		2		2		tCK

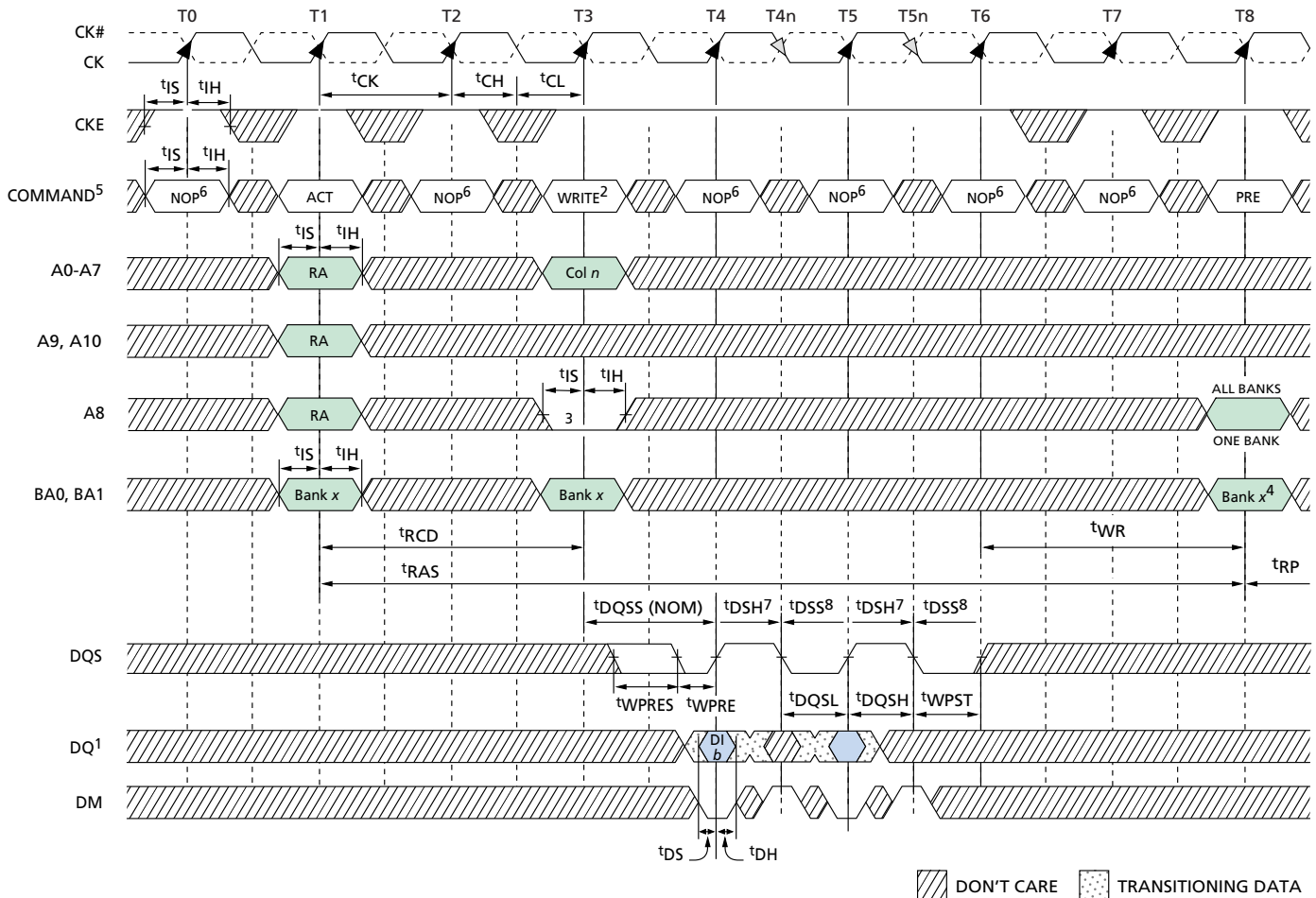
WRITE – DM OPERATION

- NOTE:**
1. DI n = data-out from column n ; subsequent elements are provided in the programmed order.
 2. Burst length = 4 in the case shown.
 3. Disable auto precharge.
 4. "Don't Care" if A8 is HIGH at T8.
 5. PRE = PRECHARGE, ACT = ACTIVE, RA = Row Address, BA = Bank Address.
 6. NOP commands are shown for ease of illustration; other commands may be valid at these times.
 7. t_{DSH} is applicable during t_{DQSS} (MIN) and is referenced from CK T4 or T5.
 8. t_{DSS} is applicable during t_{DQSS} (MAX) and is referenced from CK T5 or T6.

TIMING PARAMETERS

SYMBOL	-5		-6		-65		UNITS
	MIN	MAX	MIN	MAX	MIN	MAX	
t_{CH}	0.45	0.55	0.45	0.55	0.45	0.55	t_{CK}
t_{CL}	0.45	0.55	0.45	0.55	0.45	0.55	t_{CK}
t_{CK} (3)	5	12	6	12	6.5	12	ns
t_{CK} (2)	8	12	9	12	10	12	ns
t_{DH}	0.6		0.6		0.6		ns
t_{DS}	0.6		0.6		0.6		ns
t_{DQSH}	0.4		0.4		0.4		t_{CK}
t_{DQSL}	0.4		0.4		0.4		t_{CK}
t_{DQSS}	0.75	1.25	0.75	1.25	0.75	1.25	t_{CK}
t_{DSS}	0.25		0.25		0.25		t_{CK}

SYMBOL	-5		-6		-65		UNITS
	MIN	MAX	MIN	MAX	MIN	MAX	
t_{DSH}	0.25		0.25		0.25		t_{CK}
t_{IH}	1		1		1		ns
t_{IS}	1		1		1		ns
t_{RAS}	40	120,000	40	120,000	40	120,000	ns
t_{RCD}	20		18		19.5		ns
t_{RP}	20		18		19.5		ns
t_{WPRE}	0.25		0.25		0.25		t_{CK}
t_{WPRES}	0		0		0		ns
t_{WPST}	0.4	0.6	0.4	0.6	0.4	0.6	t_{CK}
t_{WR}	2		2		2		t_{CK}

100-PIN PLASTIC TQFP

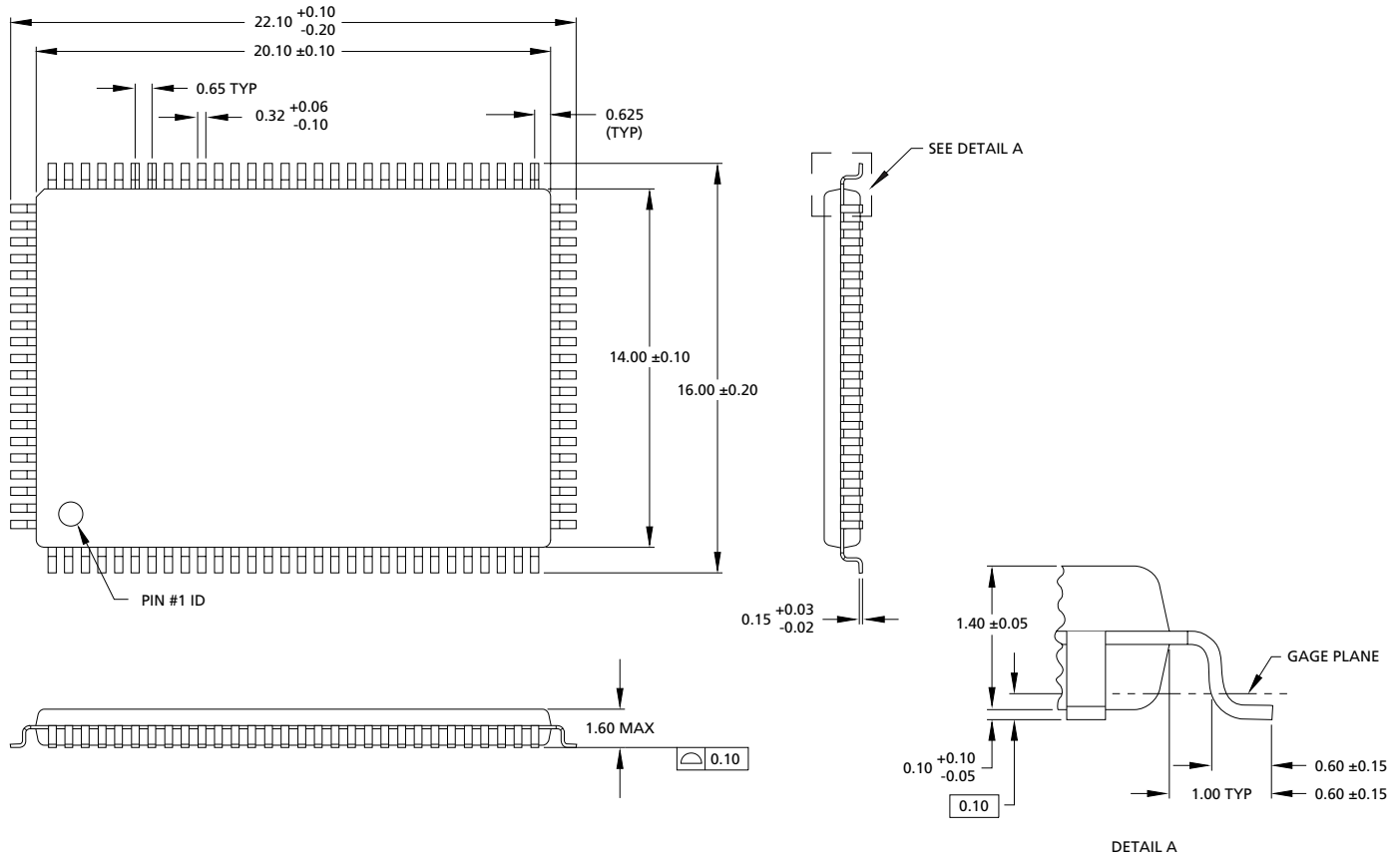

- NOTE:**
1. Package width and length do not include mold protrusion; allowable mold protrusion is 0.25mm per side.
 2. All dimensions in millimeters.



8000 S. Federal Way, P.O. Box 6, Boise, ID 83707-0006, Tel: 208-368-3900
E-mail: prodmktg@micron.com, Internet: <http://www.micron.com>, Customer Comment Line: 800-932-4992
 Micron is a registered trademark and the Micron logo and M logo are trademarks of Micron Technology, Inc.