

Features

- Design flexibility – Available in a variety sizes and colors to suit most any application.
- Durable Acrylic Panel – Offers sturdy mechanical support and device stability.
- Long lifetimes – Typically 100k hours.
- Low power consumption – Uses far less power than standard incandescent EL or CCFL light sources.

Applications

- Backlighting LCD Displays; Panels and Symbols
- Illumination of Large Surface Areas

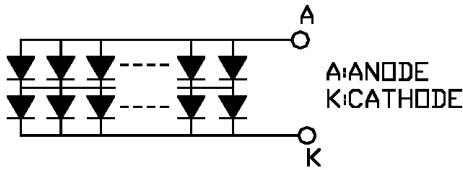
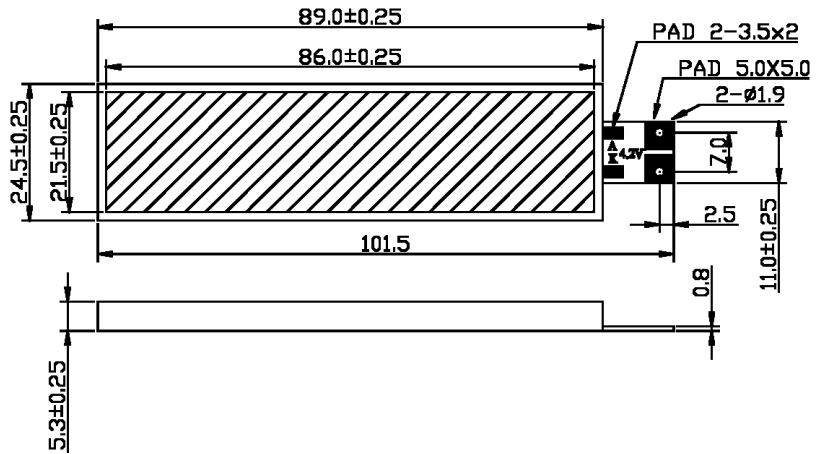

LED NUMBERS: 21X2=42

Electrical and Optical Characteristics (Ta=25°C)

Part Number	PWL nm λP	Material	View Angle 2θ _{1/2}	Luminous Intensity I _v				Forward Voltage V _F			
				min.	typ.	max.	IF@	min.	typ.	max.	IF@
MTBL2118-G	574	InGaAlP	-	-	250.00	-	20mA	-	4.00	-	20mA
-	nm	-	deg	mcd				-	V		-