

## 74LS363 Latch

Octal Transparent Latch With 3-State Outputs  
*Product Specification*

### Logic Products

#### FEATURES

- 8-bit transparent latch
- 3-state MOS compatible output buffers
- Common Latch Enable input with hysteresis
- Common 3-state Output Enable control
- Independent latch and 3-state buffer operation

#### DESCRIPTION

The '363 is an octal transparent latch coupled to eight 3-state output buffers. The two sections of the device are controlled independently by Latch Enable (E) and Output Enable ( $\overline{OE}$ ) control gates.

The data on the D inputs is transferred to the Latch outputs when the Latch Enable (E) input is HIGH. The latch remains transparent to the Data inputs while E is HIGH, and stores the data

TYPE	TYPICAL PROPAGATION DELAY	TYPICAL SUPPLY CURRENT (TOTAL)
74LS363	19ns	42mA

#### ORDERING CODE

PACKAGES	COMMERCIAL RANGE $V_{CC} = 5V \pm 5\%$ ; $T_A = 0^\circ C$ to $+70^\circ C$
Plastic DIP	N74LS363N

#### NOTE:

For information regarding devices processed to Military Specifications, see the Signetics Military Products Data Manual.

#### INPUT AND OUTPUT LOADING AND FAN-OUT TABLE

PINS	DESCRIPTION	74LS
All	Inputs	1LSul
All	Outputs	30LSul

#### NOTE:

A 74LS unit load (LSul) is  $20\mu A$   $I_{IH}$  and  $-0.4mA$   $I_{IL}$ .

present one set-up time before the HIGH-to-LOW enable transition. The enable gate has about 400mV of hysteresis

built in to help minimize problems that signal and ground noise can cause on the latching operation.

#### PIN CONFIGURATION

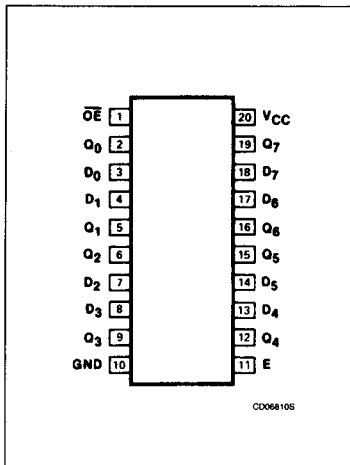

#### LOGIC SYMBOL

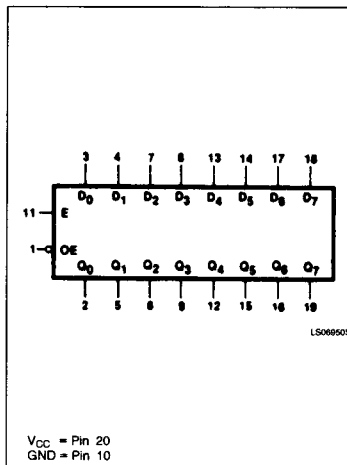

#### LOGIC SYMBOL (IEEE/IEC)

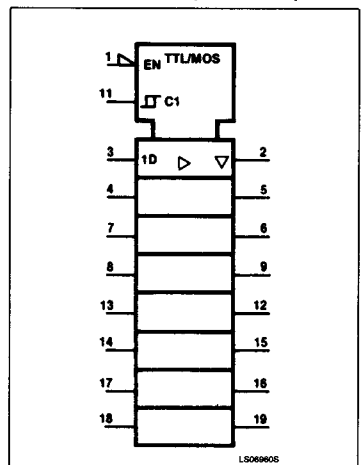

# Latch

# 74LS363

The 3-state output buffers are designed to drive heavily loaded 3-state buses, MOS memories, or MOS microprocessors. The output HIGH level differs from the normal 3-state buffer by driving the output about 1V closer to  $V_{CC}$ , or to over 3.5V at minimum  $V_{CC}$ . This

feature makes these devices ideal for driving MOS memories or microprocessors with thresholds of 2.4V to 3.5V.

The active LOW Output Enable ( $\overline{OE}$ ) controls all eight 3-state buffers independent of the

latch operation. When  $\overline{OE}$  is LOW, the latched or transparent data appears at the outputs. When  $\overline{OE}$  is HIGH, the outputs are in the HIGH impedance "off" state, which means they will neither drive nor load the bus.

## LOGIC DIAGRAM

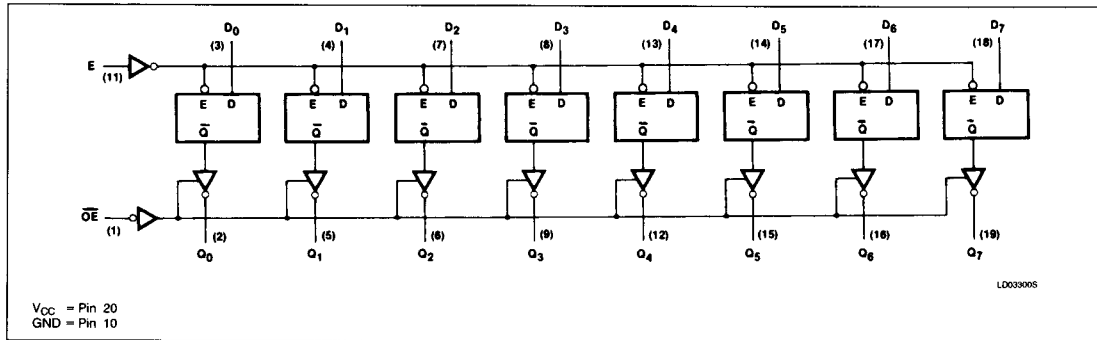

## MODE SELECT — FUNCTION TABLE

OPERATING MODES	INPUTS			INTERNAL REGISTER	OUTPUTS
	$\overline{OE}$	E	$D_n$		$Q_0 - Q_7$
Enable and read register	L	H	L	L	L
	L	H	H	H	H
Latch and read register	L	L	l	L	L
	L	L	h	H	H
Latch register and disable outputs	H	L	l	L	(Z)
	H	L	h	H	(Z)

H = HIGH voltage level  
h = HIGH voltage level one set-up time prior to the HIGH-to-LOW enable transition  
L = LOW voltage level  
l = LOW voltage level one set-up time prior to the HIGH-to-LOW enable transition  
(Z) = HIGH impedance "off" state

## ABSOLUTE MAXIMUM RATINGS (Over operating free-air temperature range unless otherwise noted.)

PARAMETER	74LS	UNIT
$V_{CC}$ Supply voltage	7.0	V
$V_{IN}$ Input voltage	-0.5 to +7.0	V
$I_{IN}$ Input current	-30 to +1	mA
$V_{OUT}$ Voltage applied to output in HIGH output state	-0.5 to $+V_{CC}$	V
$T_A$ Operating free-air temperature range	0 to 70	°C

## Latch

74LS363

## RECOMMENDED OPERATING CONDITIONS

PARAMETER		74LS			UNIT
		Min	Nom	Max	
V <sub>CC</sub>	Supply voltage	4.75	5.0	5.25	V
V <sub>IH</sub>	HIGH-level input voltage	2.0			V
V <sub>IL</sub>	LOW-level input voltage			+0.8	V
I <sub>IK</sub>	Input clamp current			-18	mA
I <sub>OH</sub>	HIGH-level output voltage			-2.6	V
I <sub>OL</sub>	LOW-level output current			24	mA
T <sub>A</sub>	Operating free-air temperature	0		70	°C

## DC ELECTRICAL CHARACTERISTICS (Over recommended operating free-air temperature range unless otherwise noted.)

PARAMETER	TEST CONDITIONS <sup>1</sup>	74LS363			UNIT
		Min	Typ <sup>2</sup>	Max	
V <sub>OH</sub>	HIGH-level output current V <sub>CC</sub> = MIN, V <sub>IH</sub> = MIN, V <sub>IL</sub> = MAX, I <sub>OH</sub> = MAX	3.65			V
V <sub>OL</sub>	LOW-level output voltage V <sub>CC</sub> = MIN, V <sub>IH</sub> = MIN, V <sub>IL</sub> = MAX	I <sub>OL</sub> = MAX	0.35	0.5	V
		I <sub>OL</sub> = 12mA (74LS)	0.25	0.4	V
V <sub>IK</sub>	Input clamp voltage V <sub>CC</sub> = MIN, I <sub>I</sub> = I <sub>IK</sub>			-1.5	V
I <sub>OZH</sub>	Off-state output current, HIGH-level voltage applied V <sub>CC</sub> = MAX, V <sub>IL</sub> = MAX, V <sub>O</sub> = 3.65V			20	μA
I <sub>OZL</sub>	Off-state output current, LOW-level voltage applied V <sub>CC</sub> = MAX, V <sub>IH</sub> = MIN, V <sub>O</sub> = 0.4V			-20	μA
I <sub>I</sub>	Input current at maximum input voltage V <sub>CC</sub> = MAX, V <sub>I</sub> = 7.0V			0.1	mA
I <sub>IH</sub>	HIGH-level input current V <sub>CC</sub> = MAX, V <sub>I</sub> = 2.7V			20	μA
I <sub>IL</sub>	LOW-level input current V <sub>CC</sub> = MAX, V <sub>I</sub> = 0.4V			-0.4	mA
I <sub>OS</sub>	Short-circuit output current <sup>3</sup> V <sub>CC</sub> = MAX	-30		-130	mA
I <sub>CC</sub>	Supply current (total) V <sub>CC</sub> = MAX, $\overline{OE}$ = 4.5V		42	70	mA

## NOTES:

- For conditions shown as MIN or MAX, use the appropriate value specified under recommended operating conditions for the applicable type.
- All typical values are at V<sub>CC</sub> = 5V, T<sub>A</sub> = 25°C.
- I<sub>OS</sub> is tested with V<sub>OUT</sub> = +0.5V and V<sub>CC</sub> = V<sub>CC</sub> MAX + 0.5V. Not more than one output should be shorted at a time and duration of the short circuit should not exceed one second.

AC ELECTRICAL CHARACTERISTICS T<sub>A</sub> = 25°C, V<sub>CC</sub> = 5.0V

PARAMETER	TEST CONDITIONS	74LS		UNIT
		C <sub>L</sub> = 15pF, R <sub>L</sub> = 2kΩ		
		Min	Max	
t <sub>PLH</sub> t <sub>PHL</sub>	Propagation delay Latch enable to output Waveform 1		30 36	ns
t <sub>PLH</sub> t <sub>PHL</sub>	Propagation delay Data to output Waveform 4		23 27	ns
t <sub>PZH</sub>	Enable time to HIGH level Waveform 2		28	ns
t <sub>PZL</sub>	Enable time to LOW level Waveform 3		36	ns
t <sub>PHZ</sub>	Disable time from HIGH level Waveform 2, C <sub>L</sub> = 5pF		20	ns
t <sub>PZL</sub>	Disable time from LOW level Waveform 3, C <sub>L</sub> = 5pF		25	ns

# Latch

# 74LS363

## AC SET-UP REQUIREMENTS $T_A = 25^\circ\text{C}$ , $V_{CC} = 5.0\text{V}$

PARAMETER	TEST CONDITIONS	74LS		UNIT
		Min	Max	
$t_W$	Latch enable pulse width	Waveform 1	15	ns
$t_s$	Set-up time, data to latch enable	Waveform 5	0	ns
$t_h$	Hold time, data to latch enable	Waveform 5	10	ns

## AC WAVEFORMS

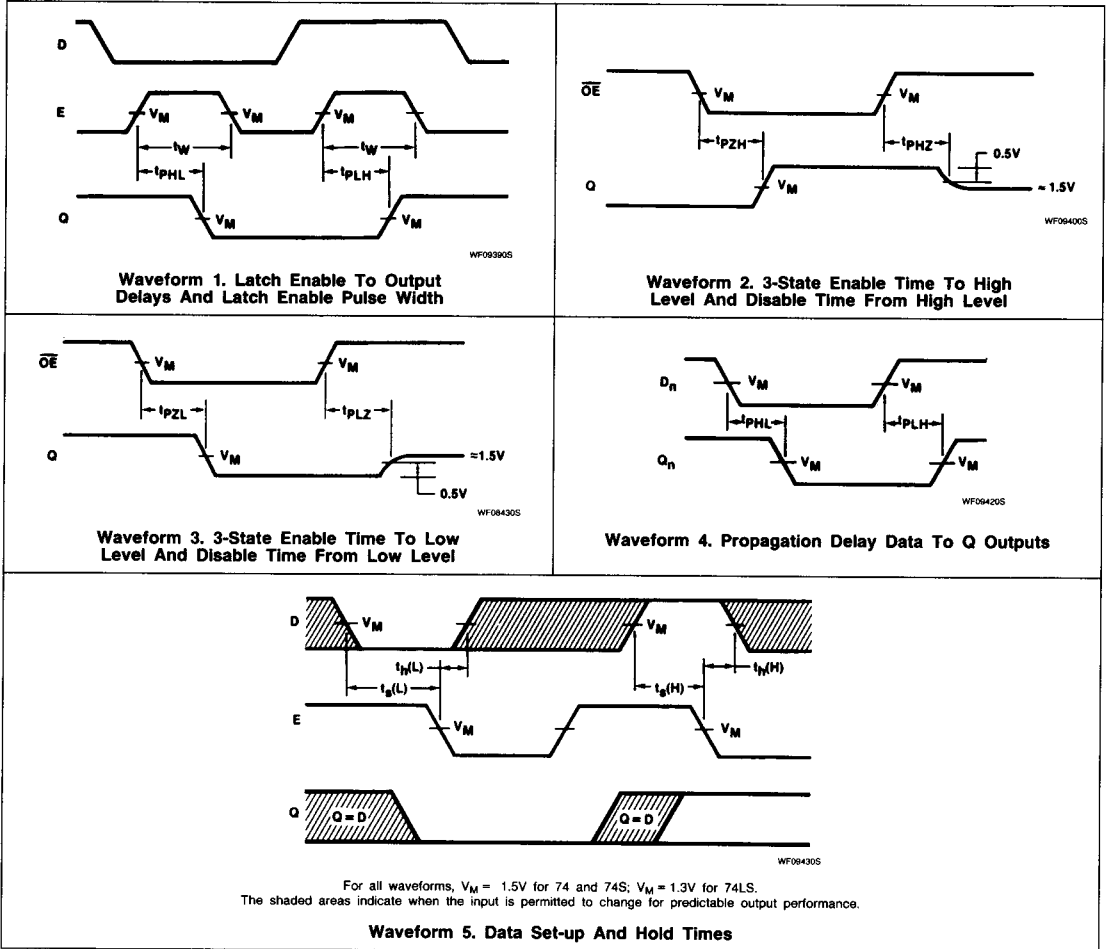

5

# Latch

# 74LS363

## TEST CIRCUITS AND WAVEFORMS

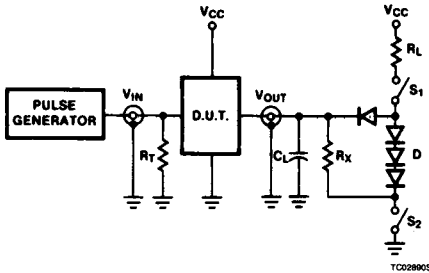

Test Circuit For 3-State Outputs

### SWITCH POSITION

TEST	SWITCH 1	SWITCH 2
t <sub>pZH</sub>	Open	Closed
t <sub>pZL</sub>	Closed	Open
t <sub>pHZ</sub>	Closed	Closed
t <sub>pLZ</sub>	Closed	Closed

### DEFINITIONS

R<sub>L</sub> = Load resistor to V<sub>CC</sub>; see AC CHARACTERISTICS for value.

C<sub>L</sub> = Load capacitance includes jig and probe capacitance; see AC CHARACTERISTICS for value.

R<sub>T</sub> = Termination resistance should be equal to Z<sub>OUT</sub> of Pulse Generators.

D = Diodes are 1N916, 1N3064, or equivalent.

R<sub>X</sub> = 1kΩ for 74, 74S, R<sub>X</sub> = 5kΩ for 74LS.

t<sub>TLH</sub>, t<sub>THL</sub> Values should be less than or equal to the table entries.

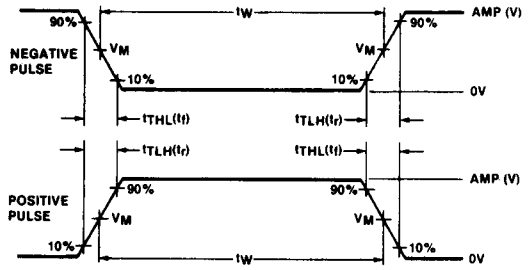

V<sub>M</sub> = 1.3V for 74LS; V<sub>M</sub> = 1.5V for all other TTL families.

### Input Pulse Definition

FAMILY	INPUT PULSE REQUIREMENTS				
	Amplitude	Rep. Rate	Pulse Width	t <sub>TLH</sub>	t <sub>THL</sub>
74	3.0V	1MHz	500ns	7ns	7ns
74LS	3.0V	1MHz	500ns	15ns	6ns
74S	3.0V	1MHz	500ns	2.5ns	2.5ns