

**FEATURES**

- Industry Standard Footprint
- Short Circuit Protection
- High Efficiency
- Under Voltage Lock Out
- Output Voltage Trimming
- Operating Temperature Range -40°C to 85°C
- SMD Construction
- Optional DC OK Signal
- Options available without Trim and Remote Sense Functionality

**DESCRIPTION**

The NNL10 series is part of a range of non-isolated, cost effective DC/DC converters offering high precision output voltages from a nominal 3.0–5.5 or 10.0–14.0 intermediate bus where isolation is not required. Available in both SMD and SIP mechanical formats.

SELECTION GUIDE <sup>1</sup>							
	Nominal Input Voltage	Output Voltage	Output Current		MAX Output Power	Nominal Efficiency	
			Min Load	Full Load			
Order Code	V	V	A	A	W	%	
<b>NNL10-1</b>	4.0	0.9	0	10.0	9.0	79.7	
<b>NNL10-2</b>	4.0	1.0	0	10.0	10.0	81.8	
<b>NNL10-3</b>	4.0	1.2	0	10.0	12.0	84.3	
<b>NNL10-4</b>	4.0	1.5	0	10.0	15.0	86.5	
<b>NNL10-5</b>	4.0	1.8	0	10.0	18.0	88.2	
<b>NNL10-6</b>	4.0	2.0	0	10.0	20.0	89.2	
<b>NNL10-7</b>	4.0	2.5	0	10.0	25.0	91.2	
<b>NNL10-8</b>	4.0	3.3	0	10.0	33.0	92.1	
<b>With DCOK</b>	<b>NNL10-9</b>	4.0	0.9	0	10.0	9.0	79.7
	<b>NNL10-10</b>	4.0	1.0	0	10.0	10.0	81.8
	<b>NNL10-11</b>	4.0	1.2	0	10.0	12.0	84.3
	<b>NNL10-12</b>	4.0	1.5	0	10.0	15.0	86.5
	<b>NNL10-13</b>	4.0	1.8	0	10.0	18.0	88.2
	<b>NNL10-14</b>	4.0	2.0	0	10.0	20.0	89.2
	<b>NNL10-15</b>	4.0	2.5	0	10.0	25.0	91.2
	<b>NNL10-16</b>	4.0	3.3	0	10.0	33.0	92.1

INPUT CHARACTERISTICS <sup>1</sup>						
Parameter	Conditions	MIN	TYP	MAX	Units	
Voltage Range	$V_{NOM} = 4.0V_{DC} V_{OUT} < 2.75V$	3.0		5.5	V	
	$V_{NOM} = 4.0V_{DC} V_{OUT} > 3.0V$	4.0		5.5		
Under Voltage Lock Out	Turn On Threshold $V_{NOM} = 4.0V_{DC}$		2.8		V	
	Turn Off Threshold $V_{NOM} = 4.0V_{DC}$		2.7			
Reflected Ripple Current			30		mA p-p	
Input No Load Current	$V_{IN} = 5.5V V_{OUT} = 0.9V$		100		mA	
	$V_{IN} = 5.5V V_{OUT} = 3.3V$		140			
Input Standby Current	$V_{IN} = 5.5V$ Module Disabled		1.5		mA	

OUTPUT CHARACTERISTICS <sup>1</sup>						
Parameter	Conditions	MIN	TYP	MAX	Units	
Rated Current	$T_A = -40^{\circ}C$ to $85^{\circ}C$ (see thermal performance characteristics)			10.0	A	
Voltage Set Point Accuracy			1.0	2.0	%	
Line Regulation	Low line to high line		0.5	1.0	%	
Load Regulation	0% load to 100% load			0.55	%	
Ripple & Noise	BW = DC to 20MHz		25	50	mVp-p	
Voltage Trim		-10		+10	% $V_{OUT}$	
Remote Sense				0.5	V	
Transient Response	$I_{OUT} = 5.0A-10.0A-5.0A,$ $C_{OUT} = 1\mu F//10\mu F$	Peak Deviation	100		mV	
		Settling Time	70		$\mu s$	
External Load Capacitance			10,000		$\mu F$	

<sup>1</sup> Specifications typical at  $T_A = 25^{\circ}C$ , nominal input voltage and rated output current unless otherwise specified.

Other customer specified options are available on request. Standard parts are supplied with Remote Sense and Voltage Trim functions. Please contact your sales representative or C&D Technologies account manager for further details.



GENERAL CHARACTERISTICS <sup>1</sup>					
Parameter	Conditions	MIN	TYP	MAX	Units
Switching Frequency			300		kHz
Start Delay	From power on/remote off		4.0		ms
Remote On/Off	Module On (or pin unconnected)	0		0.3	V
	Module Off	2.6		100	μA
MTTF		TBA		-500	μA
					kHrs

ABSOLUTE MAXIMUM RATINGS	
Short circuit protection	Continuous
Remote Sense	V <sub>OUT</sub> ±0.5V <sub>DC</sub>
DC OK	-0.2V <sub>DC</sub> to +17V <sub>DC</sub> 20mA
Remote ON/OFF	-0.2V <sub>DC</sub> to +17V <sub>DC</sub>
Trim	-0.3V <sub>DC</sub> to V <sub>OUT</sub>
Input Voltage V <sub>IN</sub>	6.5V <sub>DC</sub>
Minimum load	0%

ENVIRONMENTAL <sup>1</sup>					
Parameter	Conditions	MIN	TYP	MAX	Units
Operation	See thermal performance characteristics	-40		85	°C
Over Temperature Protection	Substrate temperature		115		°C
Storage		-55		125	°C

**OUTPUT VOLTAGE TRIMMING**

The trimming input on the NNL10 allows output voltage adjustment by +/-10% of nominal output voltage by connection of a resistor or by application of a voltage to the Trim pin.

R <sub>INTERNAL</sub> VALUES	
V <sub>OUT SET</sub> (V)	R <sub>INTERNAL</sub> (kΩ)
0.9	5.1
1.0	30.1
1.2	59.0
1.5	100.0
1.8	100.0
2.0	100.0
2.5	78.7
3.3	59.0

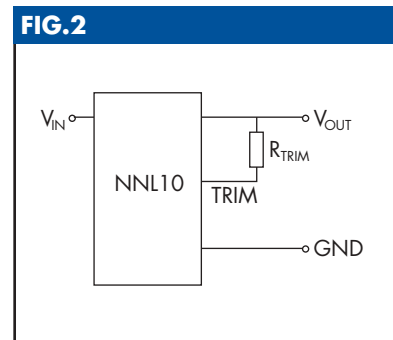
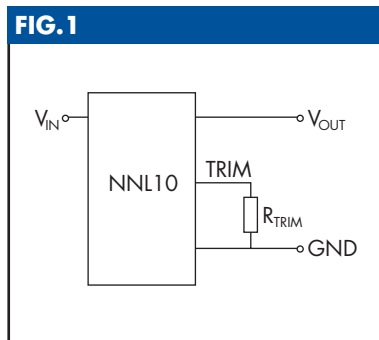

To increase the output voltage, an external resistor (Fig. 1) or voltage source should be connected between the Trim pin and GND pin.

$$R_{\text{TRIM-UP}} = \frac{24.080}{|\Delta V_{\text{OUT}}|} - R_{\text{INTERNAL}} \text{ K}\Omega \quad V_{\text{TRIM-UP}} = 0.8 - \left[ \frac{\Delta V_{\text{OUT}} \times R_{\text{INTERNAL}}}{30.100} \right]$$

ΔV<sub>out</sub> is the required change in output voltage in V

To decrease the output voltage, an external resistor (Fig. 2) or voltage source should be connected between the Trim pin and the V<sub>OUT</sub> pin.

$$R_{\text{TRIM-DOWN}} = \left[ \left( \frac{V_{\text{OUT}} - 0.8}{|\Delta V_{\text{OUT}}|} - 1 \right) \times 30.100 \right] - R_{\text{INTERNAL}} \text{ K}\Omega \quad V_{\text{TRIM-DOWN}} = 0.8 + \left[ |\Delta V_{\text{OUT}}| \times \frac{R_{\text{INTERNAL}}}{30.100} \right]$$

The trim pin should be left disconnected if not used.

**REMOTE SENSE**

**FIG.3**

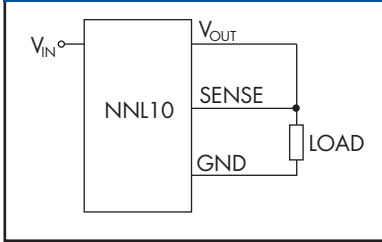

The remote sense function compensates for voltage drops from the output of the NNL10 to the load point by regulating the output voltage at the load point. The voltage drop must not exceed 0.5V, although Trim and remote sense functions can be used in combination with each other, the maximum voltage increase is 0.5V.

When increasing the output voltage the maximum output power of the NNL10 must not exceed the maximum output figures stated in the selection guide.

**OUTPUT SEQUENCING**

To simplify output sequencing, the NNL10 series offers an optional single wire interconnection that performs this function. Using this connection, up to four devices can be 'daisy chained' together, with the 'DC OK' signal from one converter signifying that the next converter can be enabled. A capacitor, simply connected to the daisy chain link, provides a settable delay in the sequence of the converters starting.

Typical capacitor values and corresponding delays are shown in the table below.

Figure 4 shows a typical sequencing configuration, along with the voltage outputs that it produces. As well as reducing component count, making use of the 'built-in' sequencing capability means that only a single PCB track is required for a full sequencing solution.

V <sub>IN</sub>	Capacitor Value	Delay
3.0VDC	0.22µF	1.8mS
5.5VDC	0.22µF	0.6mS

**FIG.4**

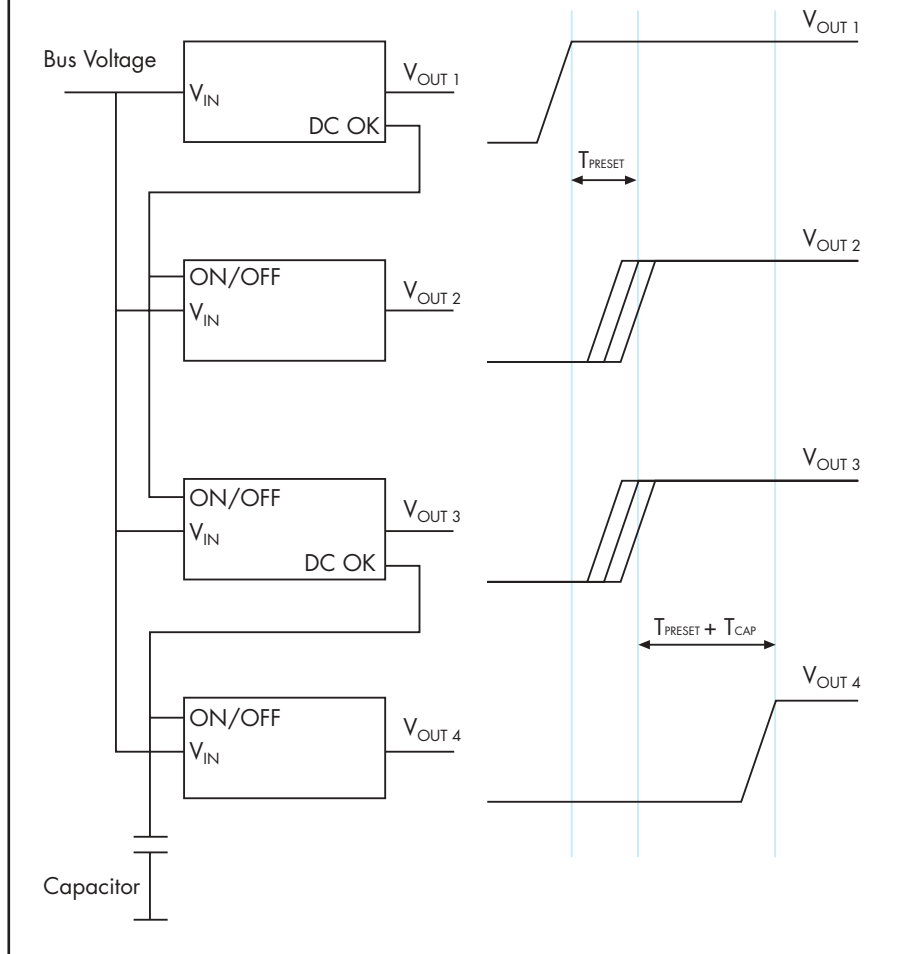

**EFFICIENCY v LOAD GRAPHS (>NNL10  $V_{NOM} = 4.0V_{DC}$ )**

**$V_{OUT} = 0.9V$**

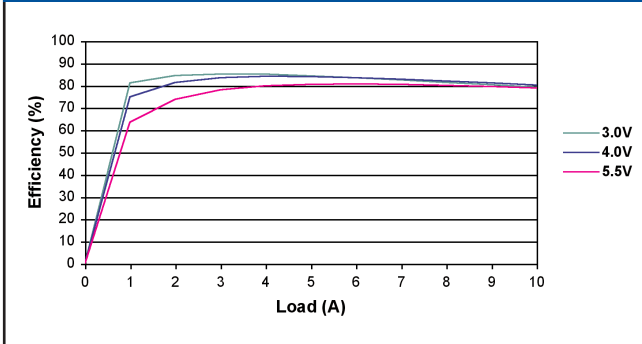

**$V_{OUT} = 1.0V$**

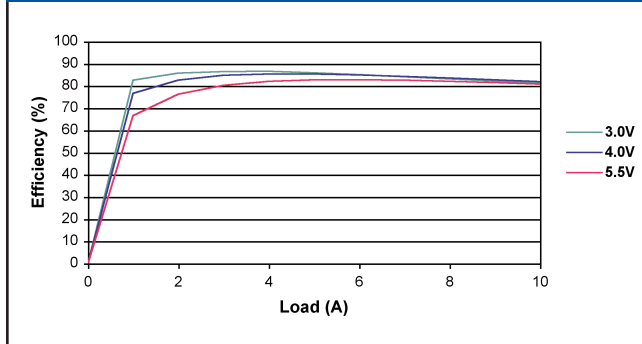

**$V_{OUT} = 1.2V$**

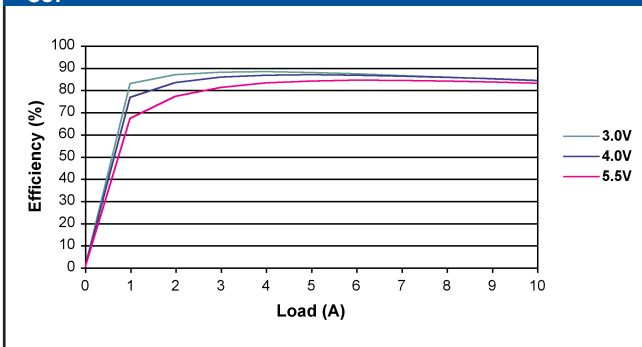

**$V_{OUT} = 1.5V$**

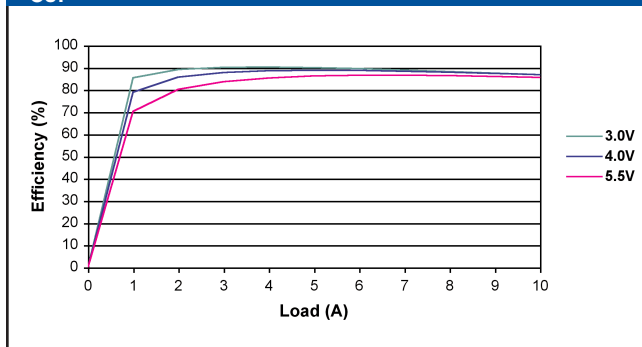

**$V_{OUT} = 1.8V$**

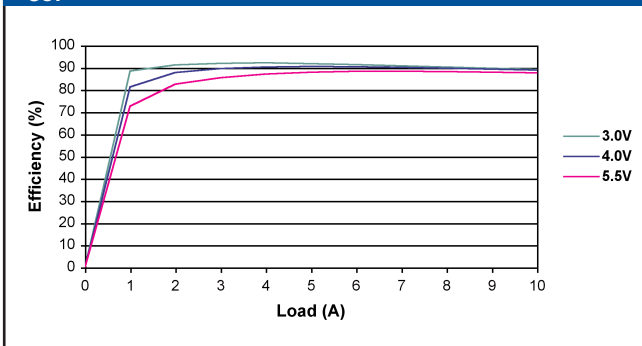

**$V_{OUT} = 2.0V$**

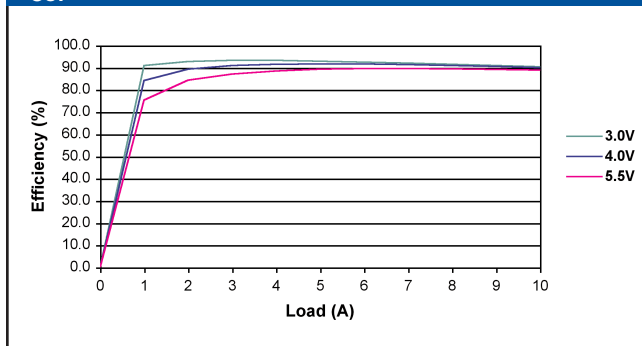

**$V_{OUT} = 2.5V$**

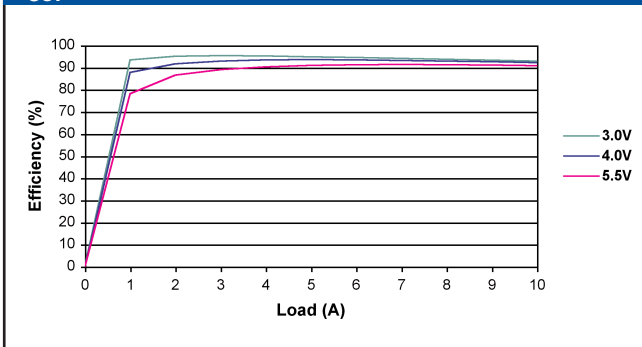

**$V_{OUT} = 3.3V$**

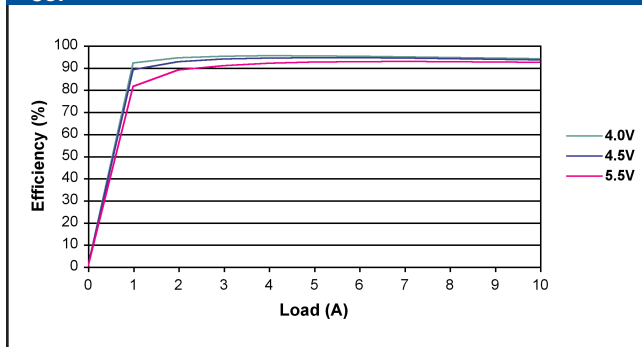

**THERMAL DERATING GRAPHS (NNL10  $V_{NOM} = 4.0V_{DC}$ )**

**$V_{OUT} = 0.9V$**

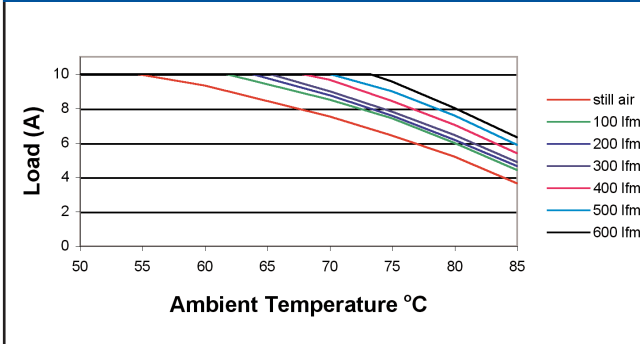

**$V_{OUT} = 1.0V$**

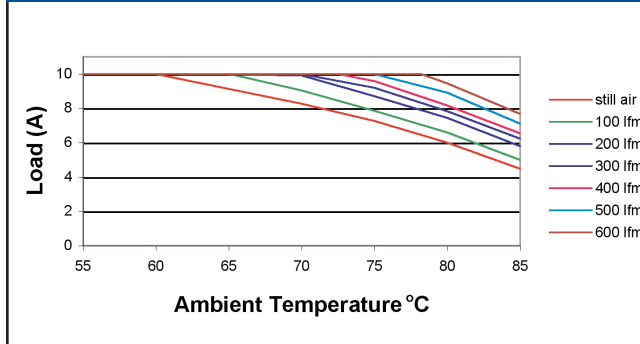

**$V_{OUT} = 1.2V$**

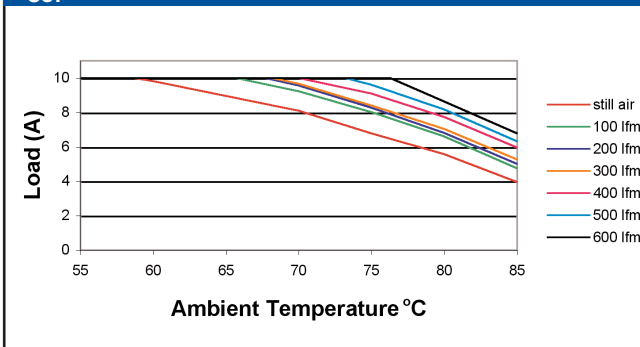

**$V_{OUT} = 1.5V$**

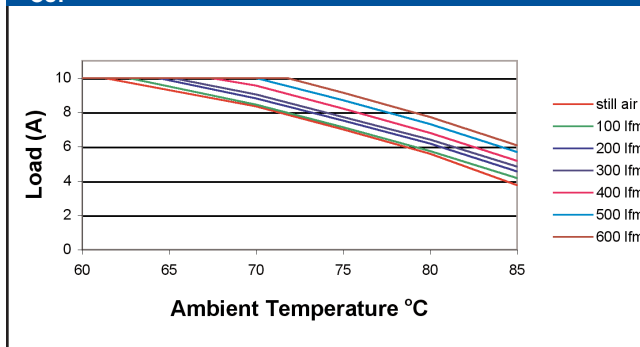

**$V_{OUT} = 1.8V$**

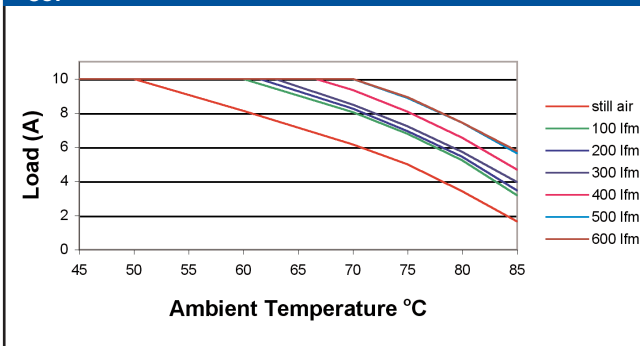

**$V_{OUT} = 2.0V$**

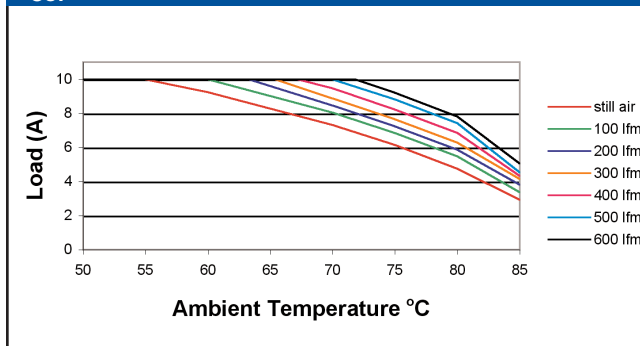

**$V_{OUT} = 2.5V$**

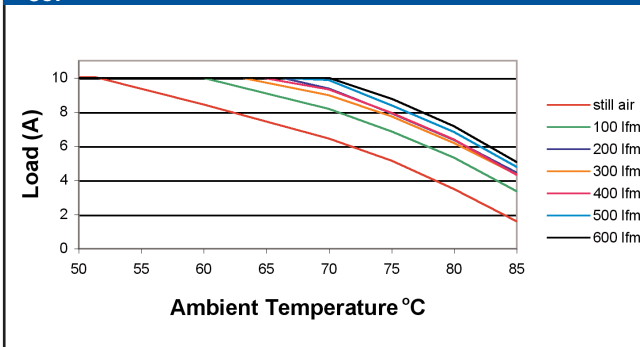

**$V_{OUT} = 3.3V$**

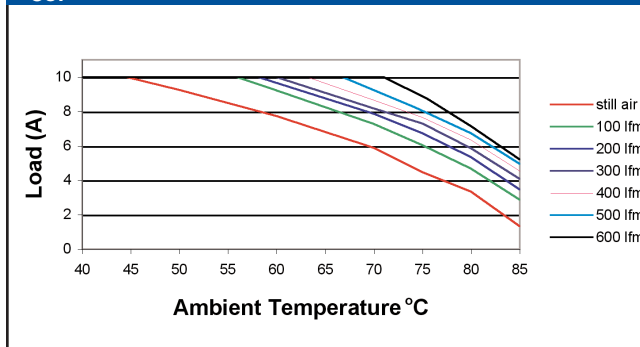

**TYPICAL CHARACTERISTICS**

**OUTPUT RIPPLE & NOISE**

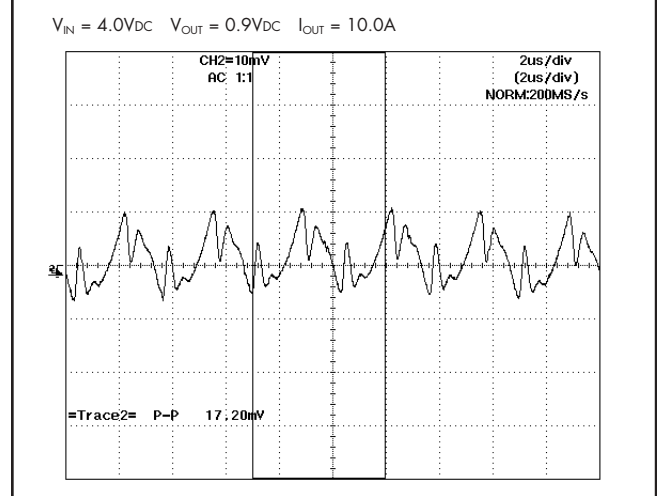
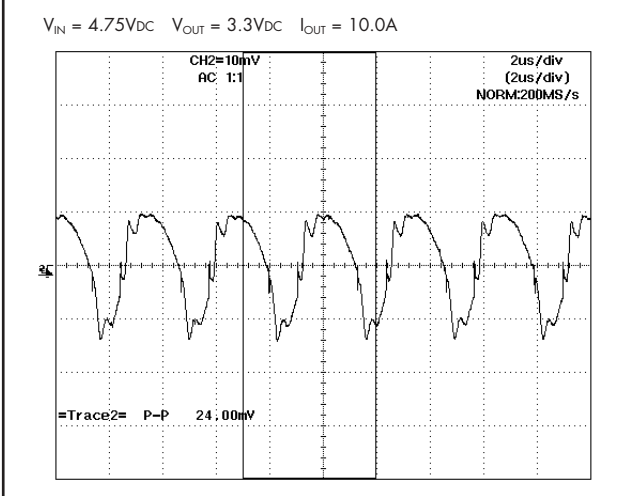

**START-UP FROM APPLICATION OF  $V_{IN}$**

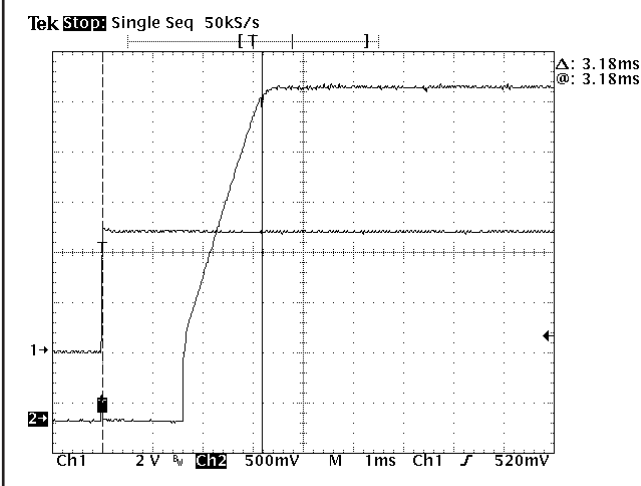

**START-UP USING REMOTE ON/OFF**

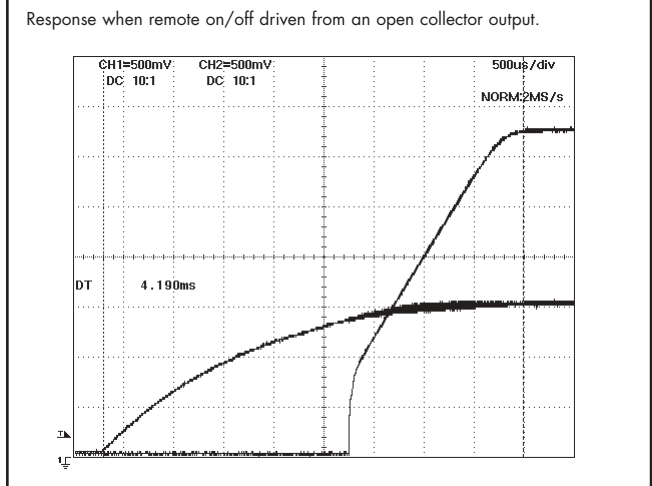

**TRANSIENT RESPONSE**

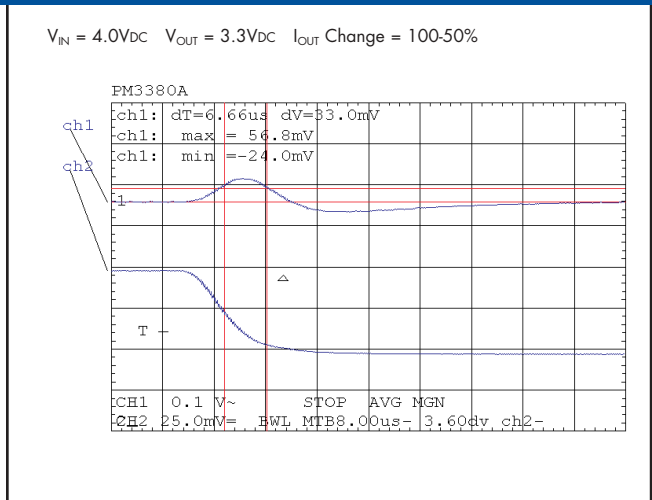
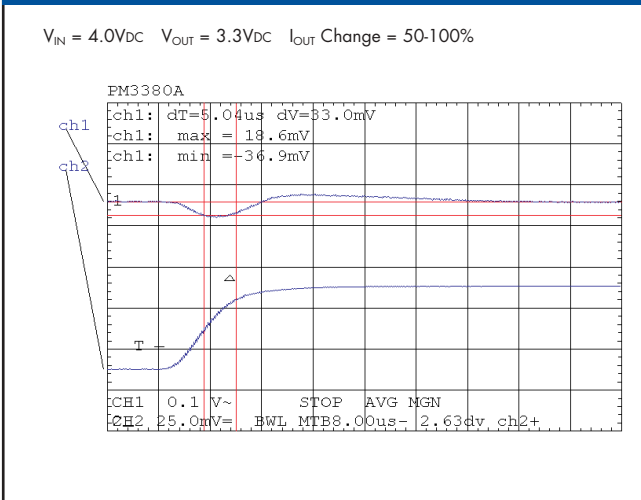

PIN CONNECTIONS						
Pin Number						
1	2	3	4	5	6	7
ON/OFF	V <sub>IN</sub>	DC OK*	GND	V <sub>OUT</sub>	TRIM	SENSE

\* Pin 6 (DC OK) is an optional feature which allows multiple NNL10 DC/DC Converters to have sequenced outputs when used in conjunction with the Remote ON/OFF pin (see application note for further information).

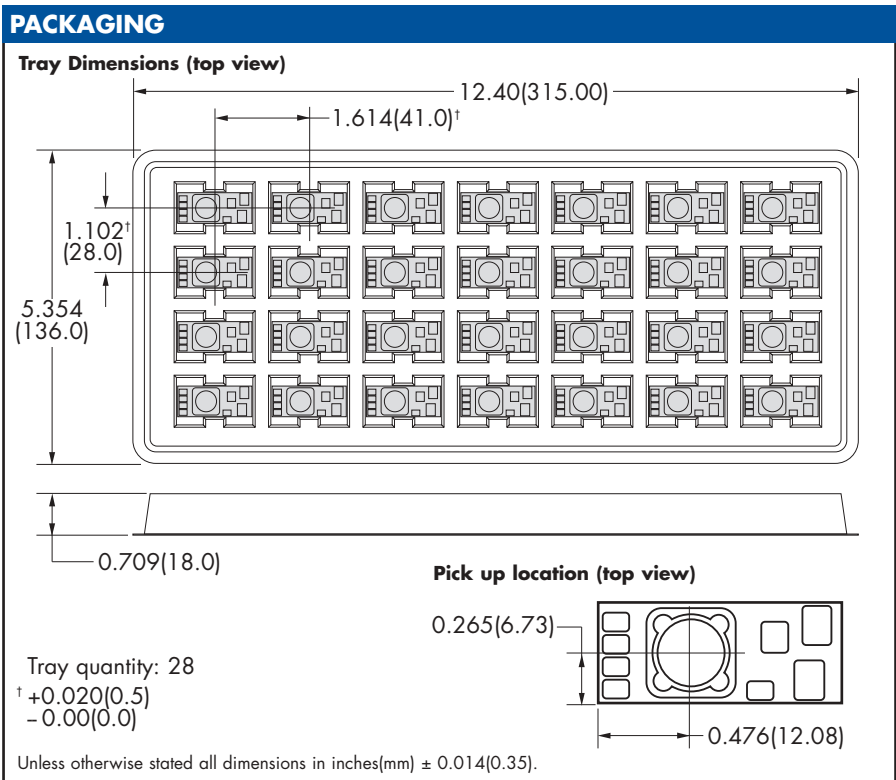
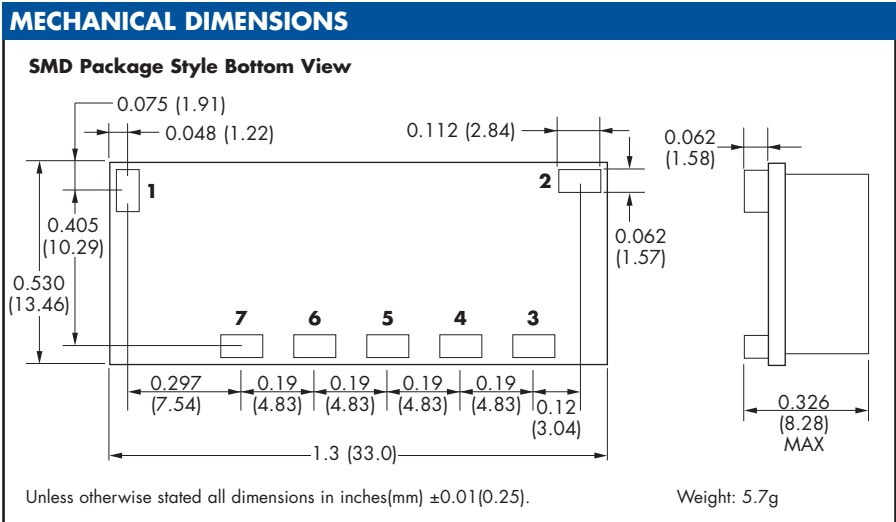

C&D Technologies Inc. reserve the right to alter or improve the specification, internal design or manufacturing process at any time, without notice. Please check with your supplier or visit our web site to ensure that you have the current and complete specification for your product before use.

© C&D Technologies Inc. 2004

NDC NNL10.2

No part of this publication may be copied, transmitted or stored in a retrieval system or reproduced in any way including, but not limited to, photography, photocopy, magnetic or other recording means, without prior written permission from C&D Technologies Inc.

Instructions for use are available from: [www.cdpoweronline.com](http://www.cdpoweronline.com)

**C&D Technologies (NCL) Ltd**  
Tanners Drive, Blakelands North  
Milton Keynes MK14 5BU, England  
Tel: +44 (0)1908 615232  
Fax: +44 (0)1908 617545  
email: [info@cdtechno-ncl.com](mailto:info@cdtechno-ncl.com)

[www.cdpoweronline.com](http://www.cdpoweronline.com)

**C&D Technologies Inc.**  
3400 E Britannia Drive, Tucson,  
Arizona 85706, USA  
Tel: +1 (800) 547-2537  
Fax: +1 (520) 741-4598  
email: [sales@cdtechno.com](mailto:sales@cdtechno.com)