

## Dimension (mm) \*1

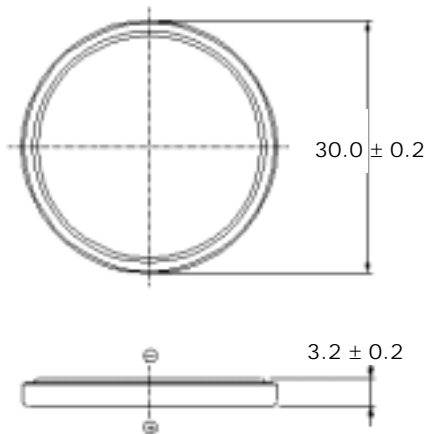

## Discharge Characteristics I

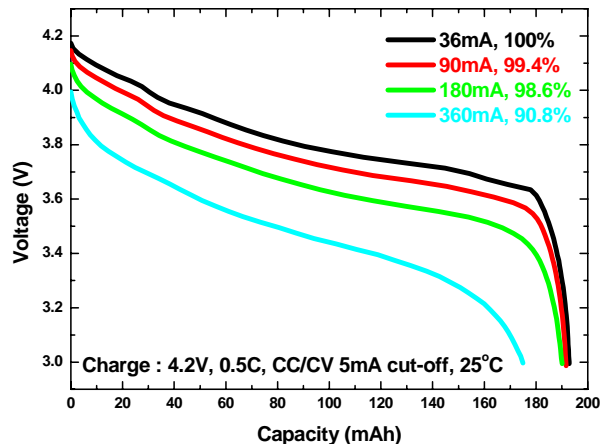

## Discharge Characteristics II

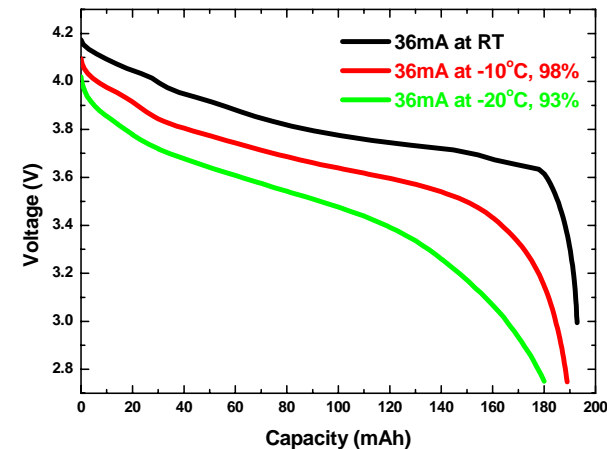

## Specification

Nominal Voltage	3.7 V
Nominal Capacity *2	180 mAh
Dimension (mm)	3.2 x 30.0
Weight( Approx.)	7.2 g
Max. Discharge Current	2 CmA (360 mA)

\*1 Dimensions of a fresh battery

\*2 Discharged at 0.2CmA(36mA), 3V cut-off

## Charge Characteristics

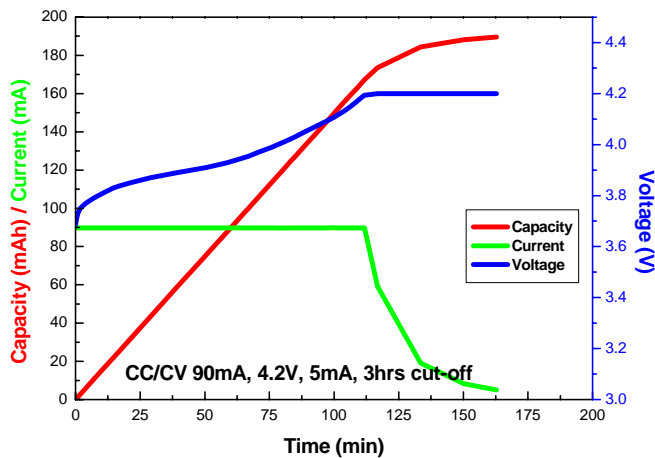

## Cycle Life Characteristics

