

ULTRA LOW CAPACITANCE TVS ARRAY

APPLICATIONS

- ✓ Sensor & Control Circuits
- ✓ FireWire
- ✓ Ethernet - 10/100/1000 Base T
- ✓ Handheld Electronics
- ✓ RF Applications

IEC COMPATIBILITY (EN61000-4)

- ✓ 61000-4-2 (ESD): Air - 15kV, Contact - 8kV
- ✓ 61000-4-4 (EFT): 40A - 5/50ns
- ✓ 61000-4-5 (Surge): 24A, 8/20 μ s - Level 2(Line-Ground) & Level 3(Line-Line)

FEATURES

- ✓ 500 Watts Peak Pulse Power per Line (tp = 8/20 μ s)
- ✓ Bidirectional Configuration
- ✓ ESD Protection > 40 kilovolts
- ✓ Low Clamping Voltage < 5 Volts
- ✓ **ULTRA LOW CAPACITANCE: 1.25pF**
- ✓ RoHS Compliant in Lead-Free Versions

MECHANICAL CHARACTERISTICS

- ✓ Molded JEDEC SO-8
- ✓ Weight 70 milligrams (Approximate)
- ✓ Available in Tin-Lead or Lead-Free Pure-Tin Plating(Annealed)
- ✓ Solder Reflow Temperature:
 - Tin-Lead - Sn/Pb, 85/15: 240-245°C
 - Pure-Tin - Sn, 100: 260-270°C
- ✓ Flammability Rating UL 94V-0
- ✓ 12mm Tape and Reel Per EIA Standard 481
- ✓ Device Marking: Marking Code, Logo, Date Code & Pin One Defined By DOT on Package



PIN CONFIGURATION

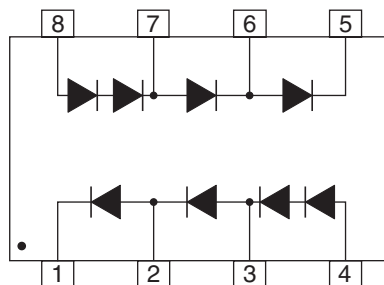

DEVICE CHARACTERISTICS

MAXIMUM RATINGS @ 25°C Unless Otherwise Specified			
PARAMETER	SYMBOL	VALUE	UNITS
Peak Pulse Power - $t_p = 8/20\mu s$ (See Figure 1)	P_{PP}	500	W
Operating Temperature	T_J	-55°C to 150°C	°C
Storage Temperature	T_{STG}	-55°C to 150°C	°C

ELECTRICAL CHARACTERISTICS PER LINE @ 25°C Unless Otherwise Specified								
PART NUMBER	DEVICE MARKING CODE	RATED STAND-OFF VOLTAGE	MINIMUM BREAKDOWN VOLTAGE (See Note 1)	MAXIMUM REVERSE LEAKAGE CURRENT (See Note 1)	MAXIMUM CLAMPING VOLTAGE (See Note 1) (See Fig. 2)	WORKING INVERSE BLOCKING VOLTAGE (See Note 2)	INVERSE BLOCKING LEAKAGE CURRENT (See Note 2)	MAXIMUM CAPACITANCE (See Note 3)
		V_{WM} VOLTS	@1mA $V_{(BR)}$ VOLTS	@ V_{WM} I_D μA	@8/20 μs V_C @ I_{PP}	V_{WB} VOLTS	@ V_{WB} I_R μA	@0V, 1MHz C pF
PLC496	VEC	1.0	2.5	20	12.5V @ 30A	75	1.0	1.25

- Note 1:** Apply positive voltage from pin 4 to 1 and pin 8 to 5.
Note 2: Apply positive voltage from pin 1 to 4 and pin 5 to 8.
Note 3: Capacitance from pin 1 to 4 < 1.25pF. Capacitance from pin 8 to 5 < 1.25pF.

FIGURE 1
PEAK PULSE POWER VS PULSE TIME

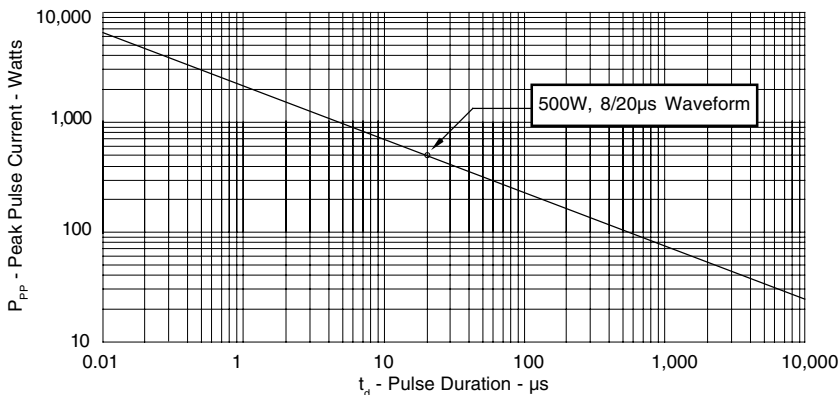
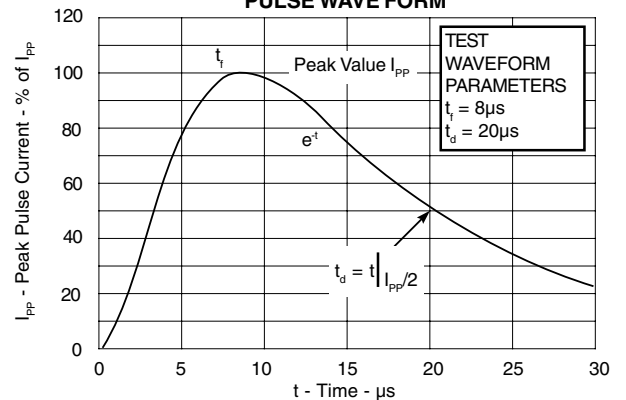
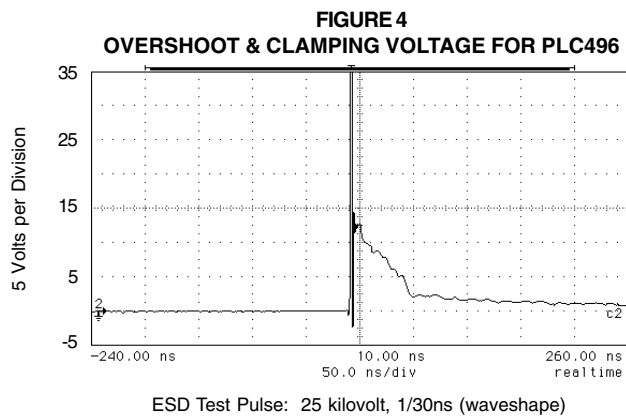
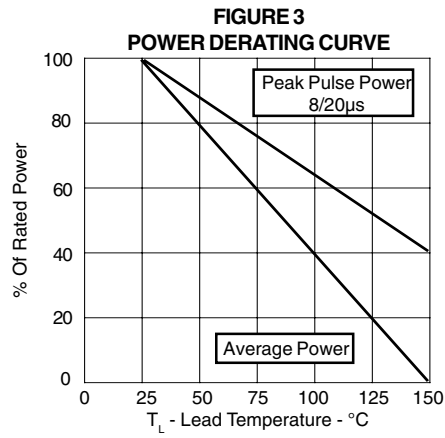

FIGURE 2
PULSE WAVE FORM



GRAPHS



APPLICATION NOTE

The PLC496 is an ultra low capacitance, bidirectional array that is designed to protect I/O or high speed data lines from the damaging effects of ESD or EFT. This product has a surge capability of 500 Watts P_{pp} per line for an 8/20 μ s waveshape and offers ESD protection > 40kV.

DIFFERENTIAL-MODE CONFIGURATION (Figure 1)

The PLC496 is designed to protect one bidirectional line where the normal signal voltage is both positive and negative. Figure 1 shows a typical differential-mode (line to line) I/O port protection circuit application.

Circuit connectivity is as follows:

- ✓ Pins 1, 4, 5 and 8 are connected to the data lines
- ✓ Pins 2, 3, 7 and 6 are not connected.

COMMON-MODE CONFIGURATION (Figure 2)

The PLC496 can provide protection for sensor circuit applications. Figure 2, is a typical common-mode (line to ground) sensor circuit application.

Circuit connectivity is as follows:

- ✓ Pins 1 and 8 connected to the dataline
- ✓ Pins 4 and 5 connected to ground
- ✓ Pins 2, 3, 6, and 7 are not connected

CIRCUIT BOARD LAYOUT RECOMMENDATIONS

Circuit board layout is critical for Electromagnetic Compatibility (EMC) protection. The following guidelines are recommended:

- ✓ The protection device should be placed near the input terminals or connectors, the device will divert the transient current immediately before it can be coupled into the nearby traces.
- ✓ The path length between the TVS device and the protected line should be minimized.
- ✓ All conductive loops including power and ground loops should be minimized.
- ✓ The transient current return path to ground should be kept as short as possible to reduce parasitic inductance.
- ✓ Ground planes should be used whenever possible. For multilayer PCBs, use ground vias.

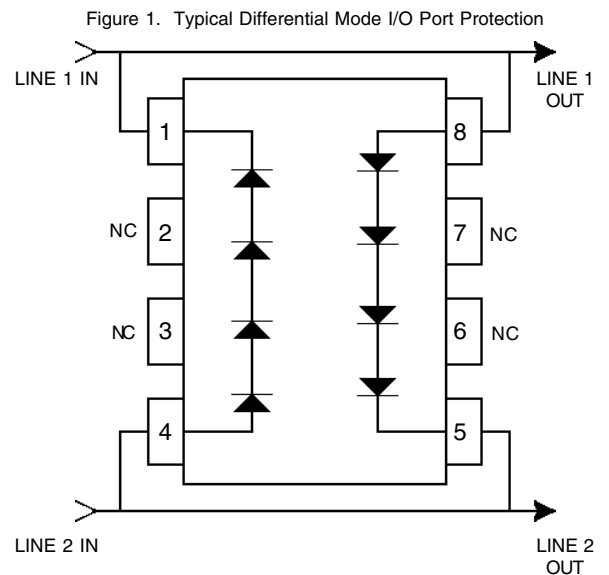
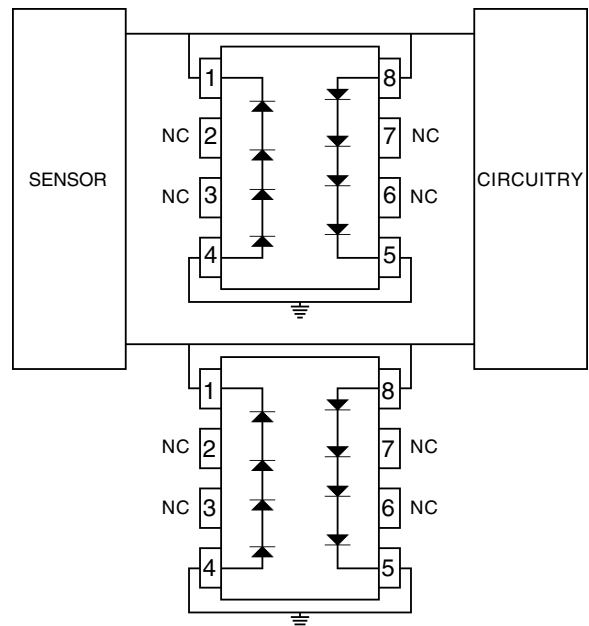
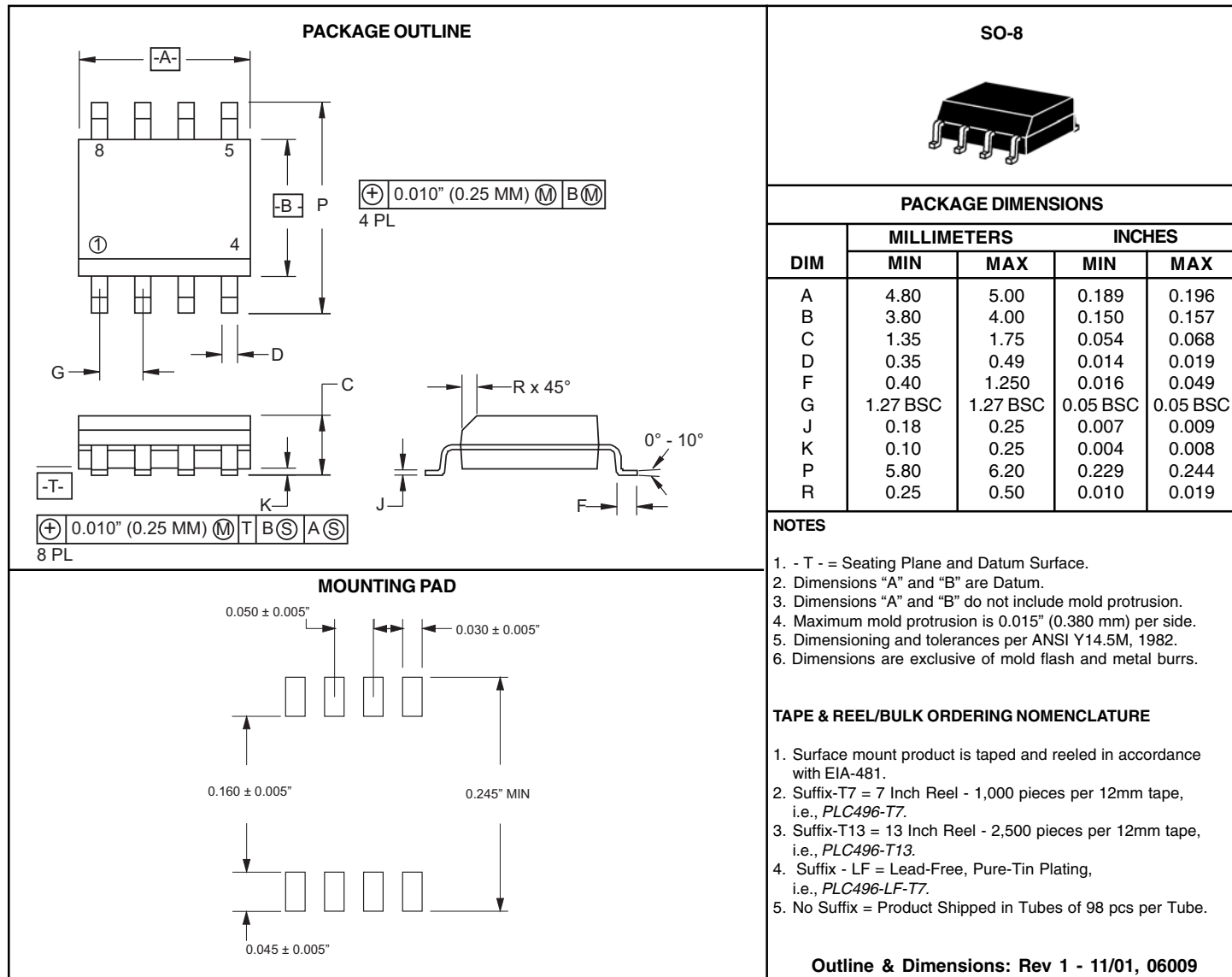

Figure 2. Typical Common Mode Sensor Protection Circuit



PACKAGE OUTLINE & DIMENSIONS



COPYRIGHT © ProTek Devices 2005

SPECIFICATIONS: ProTek reserves the right to change the electrical and or mechanical characteristics described herein without notice (except JEDEC).

DESIGN CHANGES: ProTek reserves the right to discontinue product lines without notice, and that the final judgement concerning selection and specifications is the buyer's and that in furnishing engineering and technical assistance, ProTek assumes no responsibility with respect to the selection or specifications of such products.

ProTek Devices

2929 South Fair Lane, Tempe, AZ 85282

Tel: 602-431-8101 Fax: 602-431-2288

E-Mail: sales@protekdevices.com

Web Site: www.protekdevices.com