

RMWL38001

37-40 GHz Low Noise Amplifier MMIC

Description

The RMWL38001 is a 4-stage GaAs MMIC amplifier designed as a 37 to 40 GHz Low Noise Amplifier for use in point to point radios, point to multi-point communications, LMDS, and other millimeter wave applications. In conjunction with other Raytheon amplifiers, multipliers and mixers it forms part of a complete 38 GHz transmit/receive chipset. The RMWL38001 utilizes Raytheon's 0.25µm power PHEMT process and is sufficiently versatile to serve in a variety of low noise amplifier applications.

Features

- ◆ 4 mil substrate
- ◆ Noise figure 2.7 dB (typ.)
- ◆ Small-signal gain 22 dB (typ.)
- ◆ 1dB compressed Pout 13.5 dBm (typ.)
- ◆ Chip size 2.9 mm x 1.25 mm

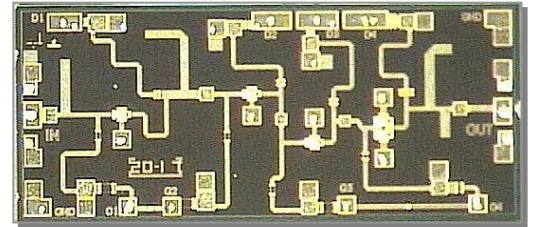

Absolute Maximum Ratings

Parameter	Symbol	Value	Unit
Positive DC voltage (+4 V Typical)	Vd	+6	Volts
Negative DC voltage	Vg	-2	Volts
Simultaneous (Vd - Vg)	Vdg	8	Volts
Positive DC current	I _D	75	mA
RF Input Power (from 50 Ω source)	P _{IN}	+6	dBm
Operating Baseplate Temperature	T _C	-30 to +85	°C
Storage Temperature Range	T _{stg}	-55 to +125	°C
Thermal Resistance (Channel to Backside)	R _{JC}	169	°C/W

Electrical Characteristics

(At 25°C),
50 Ω system,
Vd=+4 V,
Quiescent Current
Idq=50 mA

Parameter	Min	Typ	Max	Unit
Frequency Range	37		40	GHz
Gate Supply Voltage (Vg) ¹		-0.5		V
Noise Figure		2.7	4.0	dB
Gain Small Signal at Pin=-20 dBm		22		dB
Gain Variation vs. Frequency		1.5		dB
Gain at 1dB Compression		21		dB
Power Output at 1dB Compression		13.5		dBm

Parameter	Min	Typ	Max	Unit
Power Output Saturated		15		dBm
Drain Current at Pin=-20 dBm		50		mA
Drain Current at 1dB Compression		55		mA
Input Return Loss (Pin=-15 dBm)		12		dB
Output Return Loss (Pin=-15 dBm)		13		dB
OIP3		23		dBm

Note:

1. Typical range of negative gate voltage is -0.9 to -0.1 V to set typical Idq of 50 mA.

Characteristic performance data and specifications are subject to change without notice.

RMWL38001

37-40 GHz Low Noise Amplifier MMIC

Application Information

CAUTION: THIS IS AN ESD SENSITIVE DEVICE.

Chip carrier material should be selected to have GaAs compatible thermal coefficient of expansion and high thermal conductivity such as copper molybdenum or copper tungsten. The chip carrier should be machined, finished flat, plated with gold over nickel and should be capable of withstanding 325°C for 15 minutes.

Die attachment should utilize Gold/Tin (80/20) eutectic alloy solder and should avoid hydrogen environment for PHEMT devices. Note that the backside of the chip is gold plated and is used as RF and DC ground.

These GaAs devices should be handled with care and stored in dry nitrogen environment to prevent contamination of bonding surfaces. These are ESD sensitive devices and should be handled with appropriate precaution including the use of wrist grounding straps. All die attach and wire/ribbon bond equipment must be well grounded to prevent static discharges through the device.

Recommended wire bonding uses 3 mils wide and 0.5 mil thick gold ribbon with lengths as short as practical allowing for appropriate stress relief. The RF input and output bonds should be typically 0.012" long corresponding to a typically 2 mil between the chip and the substrate material.

Figure 1
Functional Block Diagram

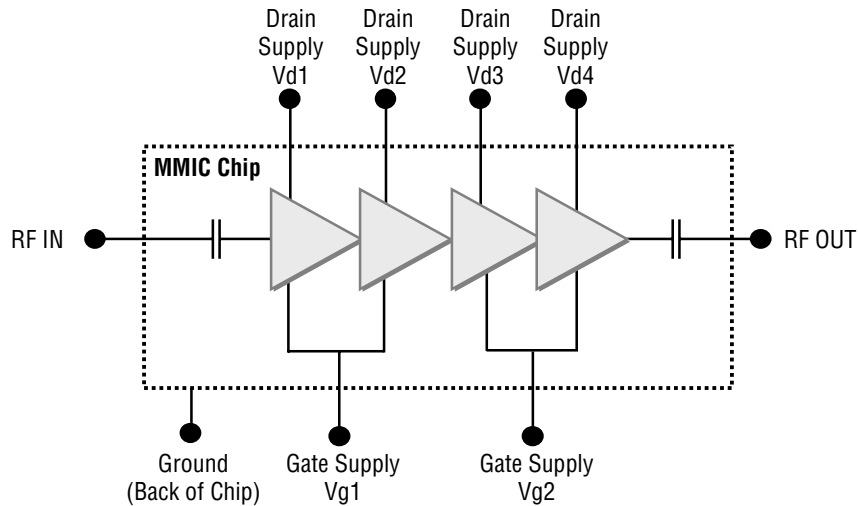
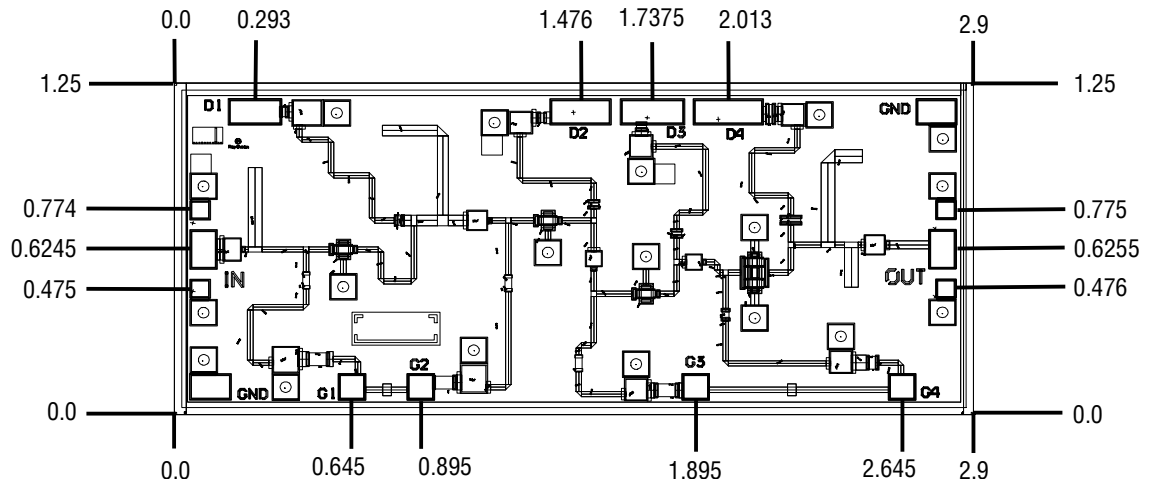

Figure 2
Chip Layout and Bond Pad Locations

Chip Size is 2.9 mm x 1.25 mm x 100 μm.
Back of chip is RF and DC ground

Dimensions in mm



Characteristic performance data and specifications are subject to change without notice.

RMWL38001

37-40 GHz Low Noise Amplifier MMIC

Figure 3
Recommended
Application Schematic
Circuit Diagram

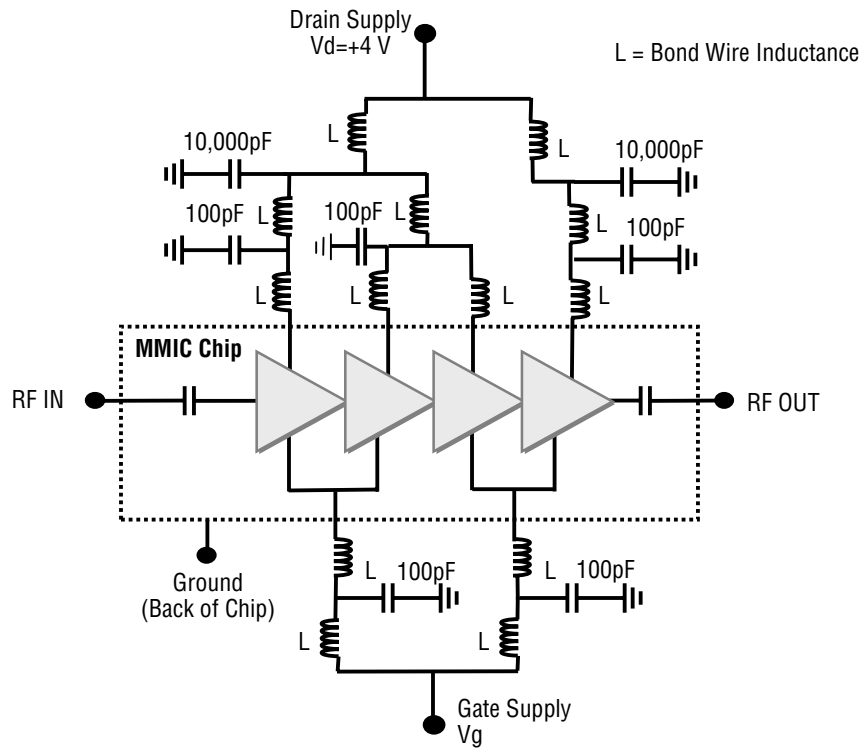
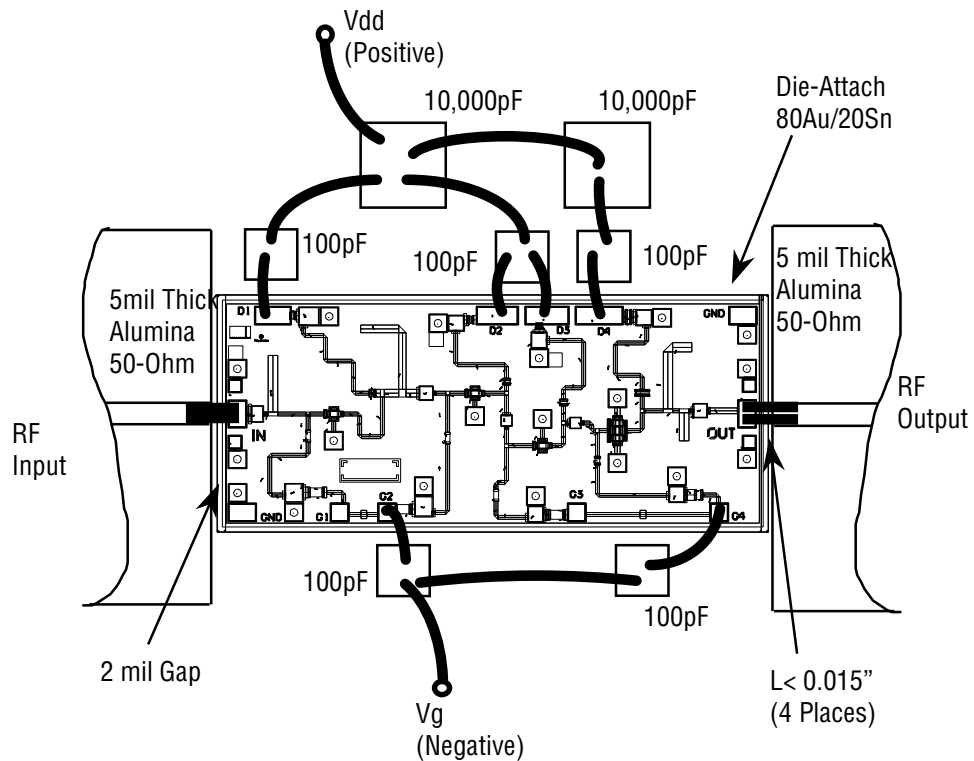

Figure 4
Recommended
Assembly Diagram



Note:
Use 0.003" by 0.0005" Gold Ribbon for bonding. RF input and output bonds should be less than 0.015" long with stress relief.

Characteristic performance data and specifications are subject to change without notice.

RMWL38001

37-40 GHz Low Noise Amplifier MMIC

Recommended Procedure
for Biasing and Operation

CAUTION: LOSS OF GATE VOLTAGE (VG) WHILE DRAIN VOLTAGE (VDS) IS PRESENT MAY DAMAGE THE AMPLIFIER CHIP.

The following sequence of steps must be followed to properly test the amplifier:

- Step 1:** Turn off RF input power.
- Step 2:** Connect the DC supply grounds to the grounds of the chip carrier.
Slowly apply negative gate bias supply voltage of -1.5 V to Vg.
- Step 3:** Slowly apply positive drain bias supply voltage of +4 V to Vd.
- Step 4:** Adjust gate bias voltage to set the quiescent current of Idq=50 mA.
- Step 5:** After the bias condition is established, RF input signal may now be applied at the appropriate frequency band.
- Step 6:** Follow turn-off sequence of:
 - (i) Turn off RF input power,
 - (ii) Turn down and off drain voltage (Vd),
 - (iii) Turn down and off gate bias voltage (Vg).

Performance Data

RMWL38001, 37-40GHz Low-Noise Amplifier, Typical Performance, Vd=4V, Idq=50mA, Chip Bonded into 50 ohm Test Fixture

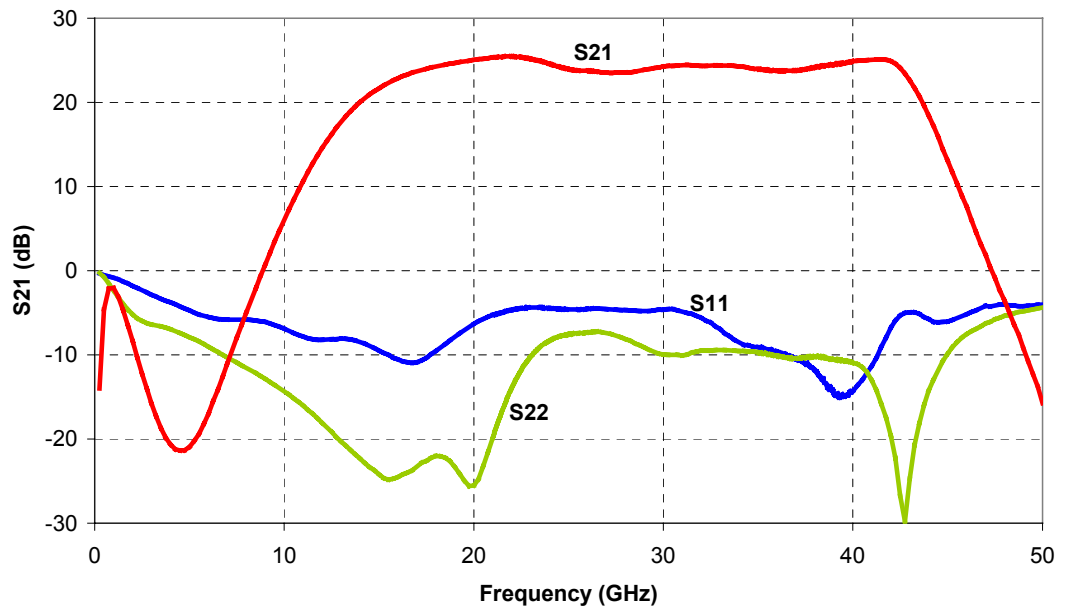

Characteristic performance data and specifications are subject to change without notice.

RMWL38001

37-40 GHz Low Noise Amplifier MMIC

Performance Data

RMWL38001, 37-40GHz Low-Noise Amplifier, Typical Performance, On-Wafer Measurements, Vd=4V, Idq=50mA

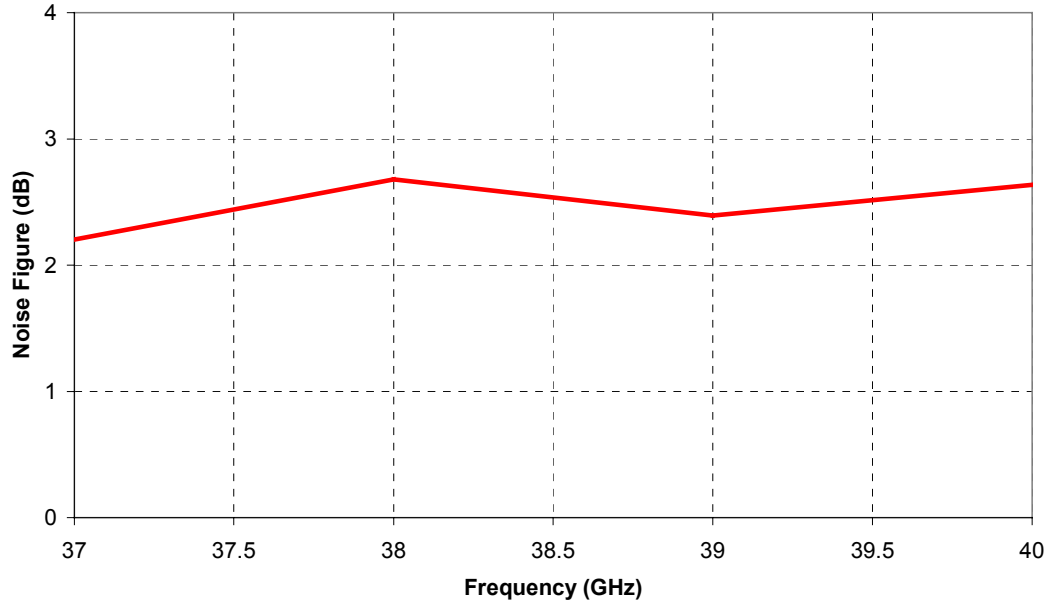

RMWL38001, 37-40GHz Low-Noise Amplifier, Typical Noise Figure, Vd=4V, Idq=50mA and 65mA, Chip Bonded into 50 ohm Test Fixture

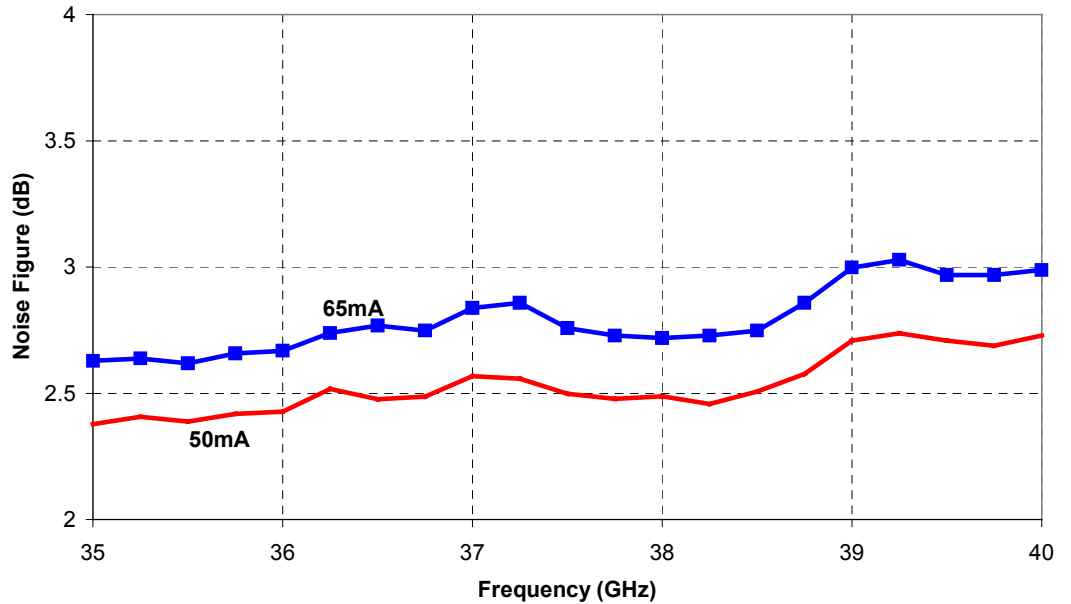

Characteristic performance data and specifications are subject to change without notice.

RMWL38001

37-40 GHz Low Noise Amplifier MMIC

Performance Data

RMWL38001, 37-40GHz Low-Noise Amplifier, Typical Performance, $V_d=4V$, $I_{dq}=50mA$ and $65mA$, Chip Bonded into 50 ohm Test Fixture

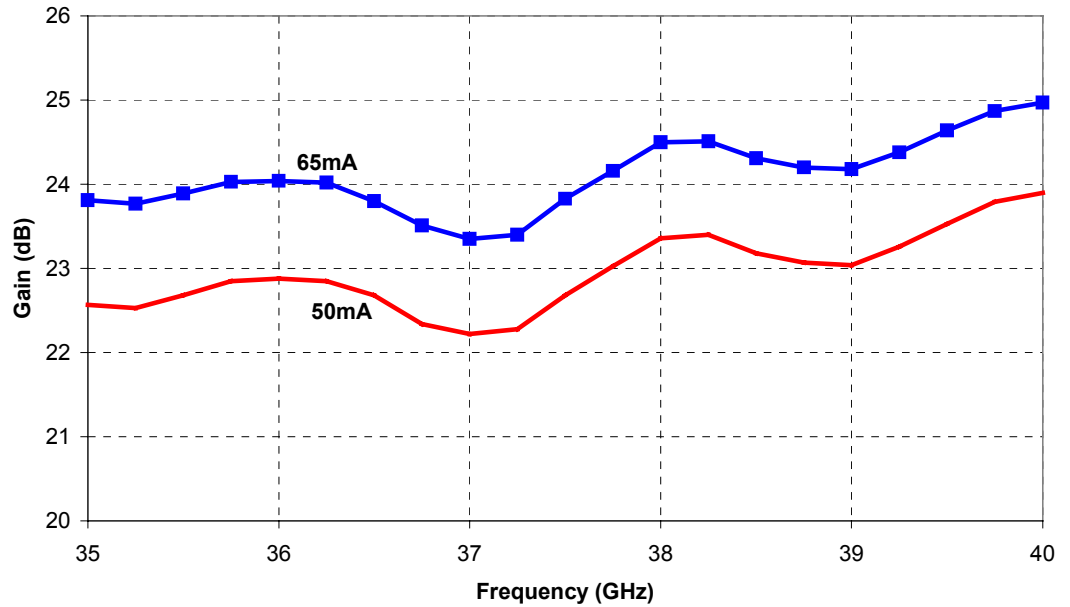

RMWL38001, 37-40GHz Low-Noise Amplifier, Typical Power Performance, On-Wafer Measurements, $V_d=4V$, $I_{dq}=50mA$

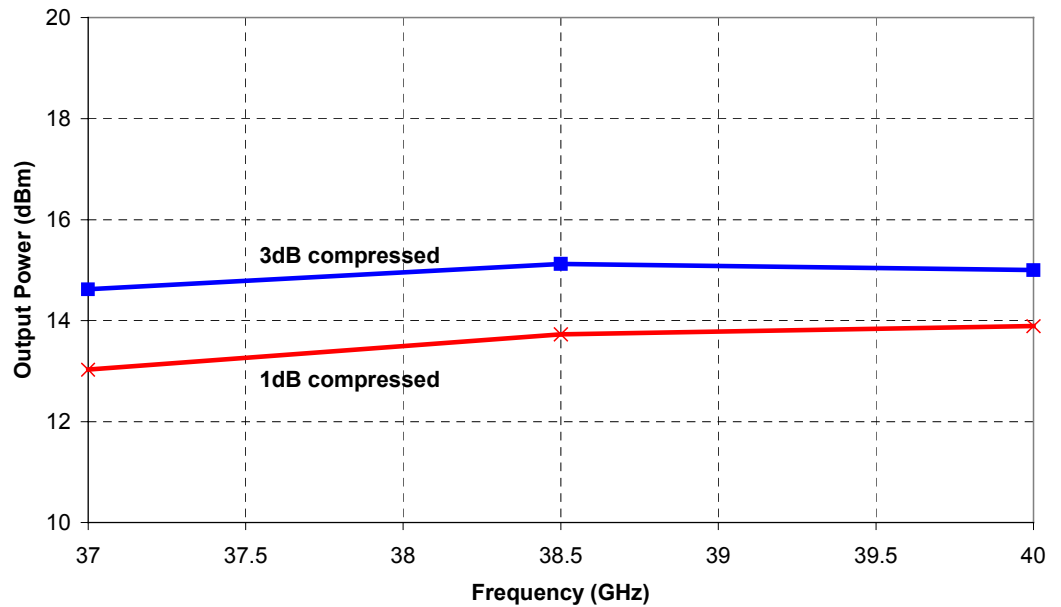

Characteristic performance data and specifications are subject to change without notice.

Worldwide Sales Representatives

North America

D&L Technical Sales
6139 S. Rural Road, #102
Tempe, AZ 85283
480-730-9553
fax: 480-730-9647
Nicholas Delvecchio, Jr.
dlarizona@aol.com

Hi-Peak Technical Sales
P.O. Box 6067
Amherst, NH 03031
866-230-5453
fax: 603-672-9228
sales@hi-peak.com

Spartech South
2115 Palm Bay Road, NE,
Suite 4
Palm Bay, FL 32904
321-727-8045
fax: 321-727-8086
Jim Morris
jim@spartech-south.com

TEQ Sales, Inc.
920 Davis Road, Suite 304
Elgin, IL 60123
847-742-3767
fax: 847-742-3947
Dennis Culpepper
dculpepper@teqsales.com

Cantec Representatives
8 Strathearn Ave, No. 18
Brampton, Ontario
Canada L6T 4L9
905-791-5922
fax: 905-791-7940
Dave Batten
cantec-ott@cantec-o.net

Steward Technology
6990 Village Pkwy #206
Dublin, CA 94568
925-833-7978
fax: 925-560-6522
John Steward
johnsteward1@msn.com

Europe

Sangus OY
Lunkintie 21,
90460 Oulunsalo
Finland
358-8-8251-100
fax: 358-8-8251-110
Juha Virtala
juha.virtala@sangus.fi

Sangus AB
Berghamnvgen 68
Box 5004
S-165 10 Hasselby
Sweden
Ronny Gustafson
468-0-380210
fax: 468-0-3720954

Globes Elektronik & Co.
Klarastrabe 12
74072 Heilbronn
Germany
49-7131-7810-0
fax: 49-7131-7810-20
Ulrich Blievernicht
hfwelt@globes.de

MTI Engineering Ltd.
Afeq Industrial Park
Hamelacha 11
New Industrial Area
Rosh Hayin 48091
Israel
972-3-902-5555
fax: 972-3-902-5556
Adi Peleg
adi_p@mti-group.co.il

Sirces srl
Via C. Boncompagni, 3B
20139 Milano
Italy
3902-57404785
fax: 3902-57409243
Nicola Iacovino
nicola.iacovino@sirces.it

Asia

ITX Corporation
2-5, Kasumigaseki
3-Chome
Chiyoda-Ku
Tokyo 100-6014 Japan
81-3-4288-7073
fax: 81-3-4288-7243
Maekawa Ryosuke
maekawa.ryosuke@
itx-corp.co.jp

Sea Union
9F-1, Building A, No 19-3
San-Chung Road
Nankang Software Park
Taiwan, ROC
Taipei 115
02-2655-3989
fax: 02-2655-3918
Murphy Su
murphy@seaunionweb.com.tw

Worldwide Distribution

Headquarters
6321 San Ignacio Drive
San Jose, CA 95119
408-360-4073
fax: 408-281-8802
Art Herbig
art.herbig@avnet.com

Belgium and Luxembourg
Cipalstraat
2440 GEEL
Belgium
32 14 570670
fax: 32 14 570679
sales.be@bfioptilas.avnet.com

United Kingdom
Burnt Ash Road
Aylesford, Kent
England
ME207XB
44 1622882467
fax: 44 1622882469
rfsales.uk@
bfioptilas.avnet.com

France
4 Allee du Cantal
Evry, Cedex
France
33 16079 5900
fax: 33 16079 8903
sales.fr@
bfioptilas.avnet.com

Holland
Chr. Huygensweg 17
2400 AJ ALPHEN AAN DEN
RIJN
The Netherlands
31 172 446060
fax: 33 172 443414
sales.nl@
bfioptilas.avnet.com

Spain
C/Isobel Colbrand, 6 - 4a
28050 Madrid
Spain
34 913588611
fax: 34 913589271
sales.es@
bfioptilas.avnet.com

Sales Office Headquarters

United States (East Coast)
Raytheon
362 Lowell Street
Andover, MA 01810
978-684-8628
fax: 978-684-8646
Walter Shelmet
wshelmet@
rrfc.raytheon.com

United States (West Coast)
Raytheon
362 Lowell Street
Andover, MA 01810
978-684-8919
fax: 978-684-8646
Rob Sinclair
robert_w_sinclair@
rrfc.raytheon.com

Europe
Raytheon
AM Teckenberg 53
40883 Ratingen
Germany
49-2102-706-155
fax: 49-2102-706-156
Peter Hales
peter_j_hales@
raytheon.com

Asia
Raytheon
Room 601, Gook Je Ctr. Bldg
191 Hangang Ro 2-GA
Yongsan-Gu, Seoul,
Korea 140-702
82-2-796-5797
fax: 82-2-796-5790
T.G. Lee
tg_lee@
rrfc.raytheon.com

Customer Support

978-684-8900

fax: 978-684-5452

customer_support@rrfc.raytheon.com