

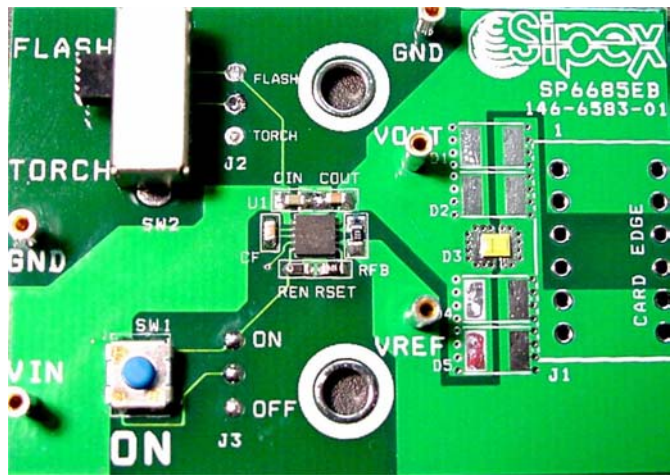

SP6686EB Evaluation Board Manual

- 2.7V to 5.5V Input Range
- Typical 150mA Torch or 400mA Flash Output Current
- High Efficiency in 1X mode, high V_{OUT} in 2X mode
- Small 3x3mm 10-Pin DFN Package
- 2.4MHz Switching Frequency Enables Small Components
- Integrated Design with Minimal Components.
- Use with 1 cell Lithium Ion Battery



DESCRIPTION AND BOARD SCHEMATIC

The **SP6686EB Evaluation Board** is a compact circuit including the SP6686 in 3x3mm DFN and 3 small 0603 capacitors which can provide a stable drive current for a 1W LED such as the AOT White LED, Lumi-LEDs Luxeon I or PWF1 type light sources. The evaluation board is a completely assembled and tested surface mount board which provides easy probe access points to all SP6686 inputs and outputs so that the user can quickly connect and measure electrical characteristics and waveforms.

SP6686EB Schematic

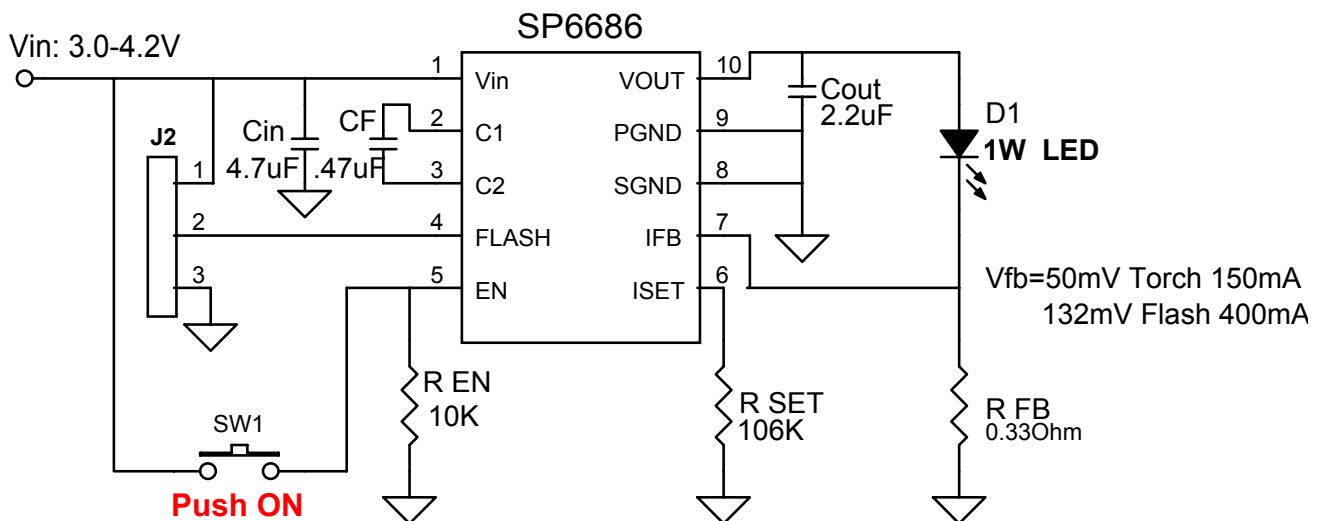

TO GET STARTED:

1. Connect VIN from VIN to GND (VIN range 2.7V to 4.2V).
2. Select mode between TORCH and FLASH by putting jumper into corresponding position.
3. Apply High to ON terminal to turn the LED on.

POWER SUPPLY DATA

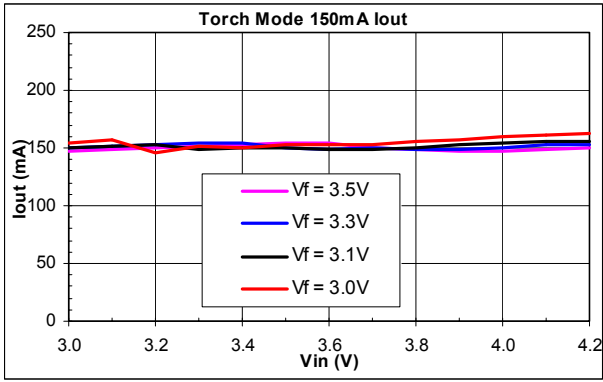

Figure 1. Torch Mode Output Current

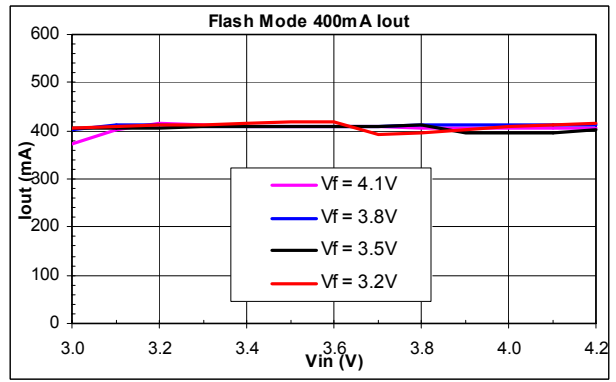

Figure 2. Flash Mode Output Current

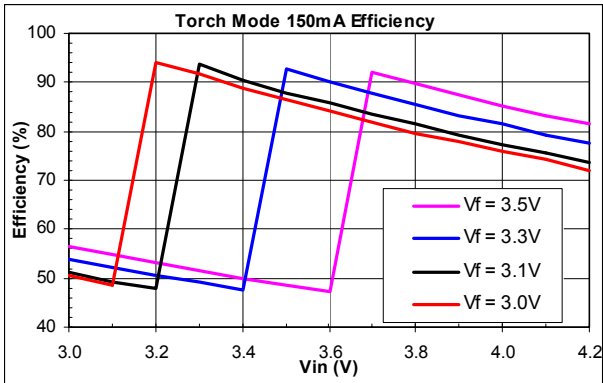

Figure 3. Torch Mode Efficiency

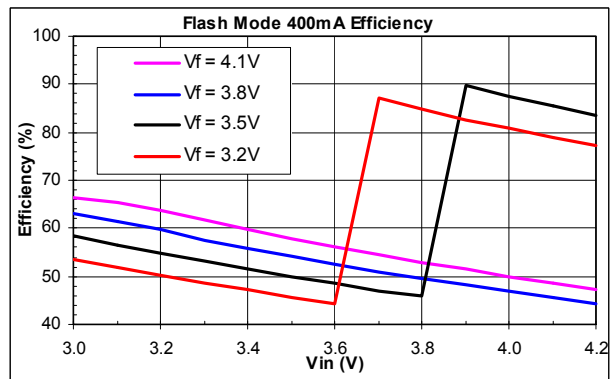

Figure 4. Flash Mode Efficiency

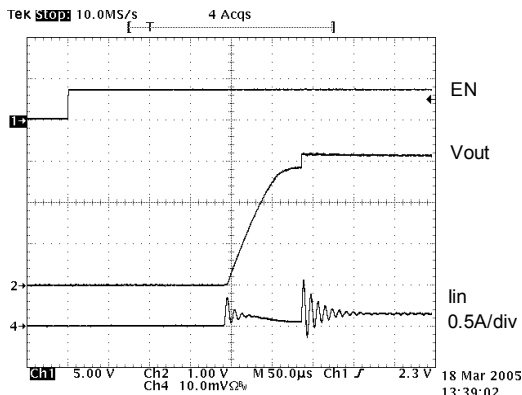

Figure 5. Startup 150mA Torch, $V_{in}=3.6V$, $V_{out}=3.1V$.

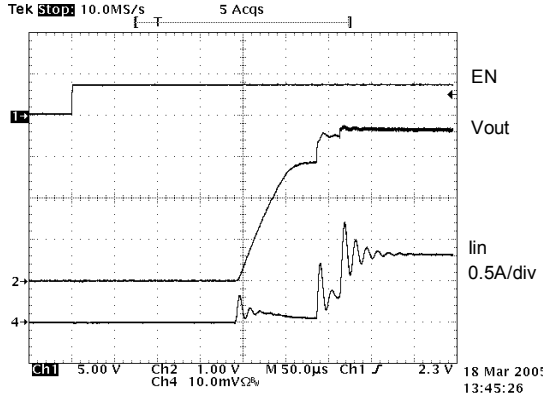

Figure 6. Startup 400mA Flash, $V_{in}=3.6V$, $V_{out}=3.5V$.

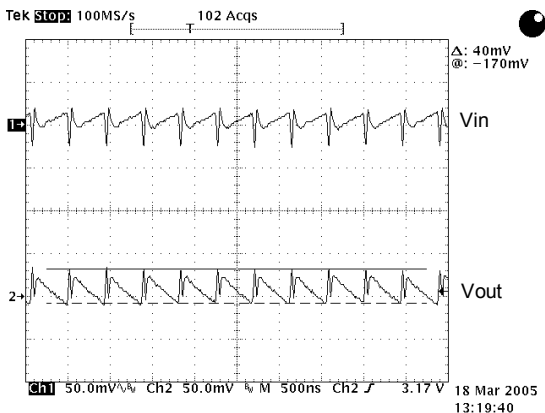

Figure 7. Ripple 150mA Torch, $V_{in}=4.2V$, $V_{out}=3.1V$. $C_{in}=4.7\mu F$, $C_{FC}=0.47\mu F$, $C_{out}=2.2\mu F$.

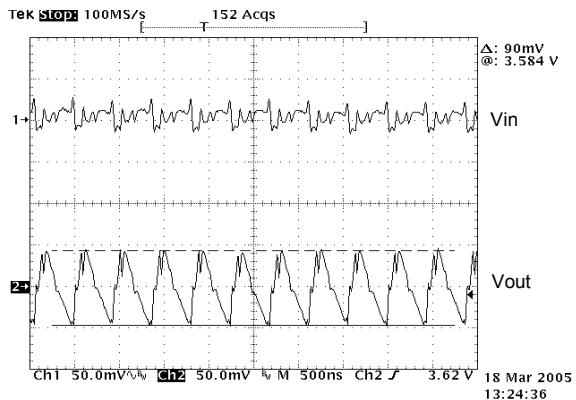

Figure 8. Ripple 400mA Flash, $V_{in}=3.6V$, $V_{out}=3.5V$. $C_{in}=4.7\mu F$, $C_{FC}=0.47\mu F$, $C_{out}=2.2\mu F$.

EVALUATION BOARD LAYOUT

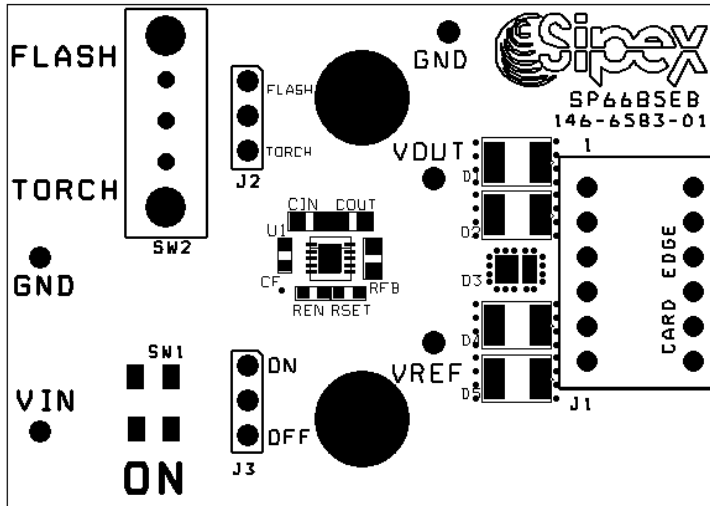

FIGURE 9: SP6686EB COMPONENT PLACEMENT

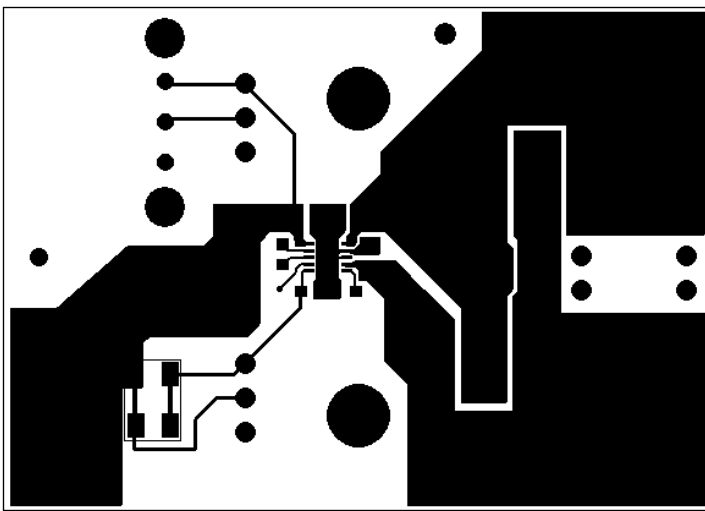

FIGURE 10: SP6686EB PC LAYOUT TOP SIDE

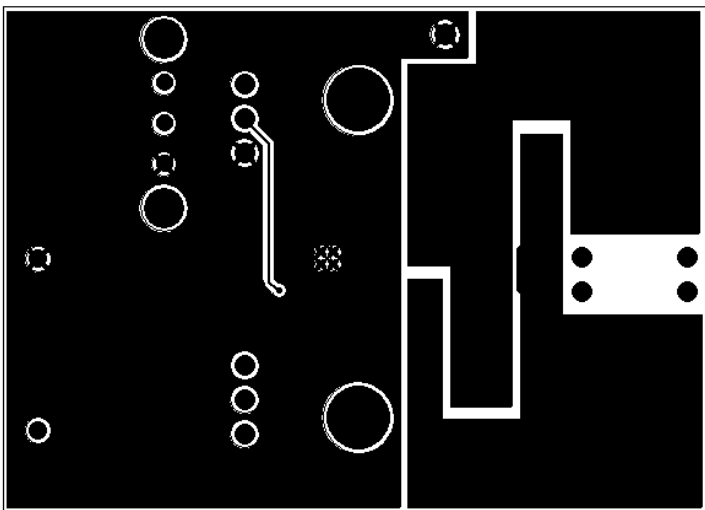

FIGURE 11: SP6686EB PC LAYOUT BOTTOM SIDE

TABLE1: SP6686EB LIST OF MATERIALS

| Part Reference | Part Number | Value | Size | Manufacturers/ Website |
|----------------|--------------------|-------------|--------------------|------------------------|
| U1 | SP6686ER | | 3x3mm DFN - 10 pin | Sipex/www.sipex.cpm |
| CIN | GRM188R60J475KE19D | 4.7uF/6.3V | 0603/X5R/0.9mm ht | Murata/www.murata.com |
| CF | GRM155R60J105KE19B | 0.47uF/6.3V | 0402/X5R/0.5mm ht | Murata/www.murata.com |
| COUT | GRM188R60J225KE19D | 2.2uF/6.3V | 0603/X5R/0.9mm ht | Murata/www.murata.com |
| RSET | - | 106K | 0402 | Rohm www.rohm.com |
| | | | | Cyntec www.cyntec.com |
| RSENSE | - | 0.33ohms | 0603 | Cyntec www.cyntec.com |

ORDERING INFORMATION

| Model | Temperature Range | Package Type |
|---------------|---------------------|---------------------------|
| SP6686EB..... | -40°C to +85°C..... | SP6686EB Evaluation Board |
| SP6686ER..... | -40°C to +85°C..... | 10-pin 3x3 DFN |