



STM376-2

RF POWER MODULE WIRELESS LOCAL LOOP APPLICATIONS

PRELIMINARY DATA

- LINEAR POWER AMPLIFIER
- 350-376 MHz
- 20 VOLTS
- INPUT/OUTPUT 50 OHMS
- $P_{OUT} = 1.0 W_{AVG}$ (2.0 W PEP)
- GAIN = 21 dB

DESCRIPTION

The STM376-2 module is designed to be used as a linear RF Power Amplifier for WLL or other fixed radio access subscriber applications. This particular model is one of several in design covering the 300-500 MHz frequency range in individual bandwidths of 25 MHz each.

Band splits and corresponding part numbers for all bands are as follows:

STM326-2	300-326 MHz	
STM351-2	325-351 MHz	PROTOTYPES
STM376-2	350-376 MHz	AVAILABLE

STM401-2	375-401 MHz
STM426-2	400-426 MHz
STM451-2	425-451 MHz
STM476-2	450-476 MHz
STM500-2	475-500 MHz

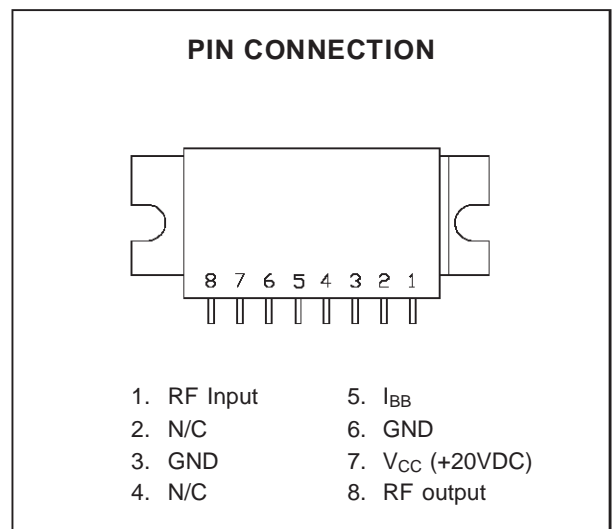
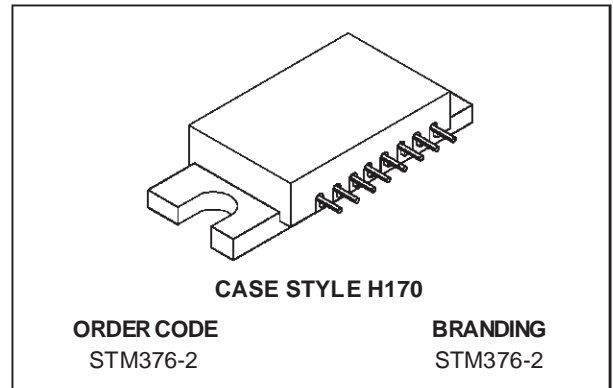

ABSOLUTE MAXIMUM RATINGS ($T_{case} = 25^{\circ}C$)

Symbol	Parameter	Value	Unit
V_{CC}	DC Supply Voltage	+21	Vdc
$I_{CC(q)}$	Quiescent Current (pin 7)	200	mAdc
I_{CC}	Operating Current (pin 7)	500	mAdc
P_{IN}	RF Input Power	30	mW
P_{OUT}	RF Output Power	2.0	W_{AVG}
T_{STG}	Storage Temperature	-30 to +100	$^{\circ}C$
T_C	Operating Case Temperature	- 20 to +60	$^{\circ}C$

ELECTRICAL SPECIFICATIONS (T_{case} = 30°C, V_{CC} = 20.0Vdc, V_{BB} = 8.8 Vdc)

Symbol	Parameter	Test Conditions	Value			Unit
			Min.	Typ.	Max.	
BW	Frequency Range		350	—	376	MHz
G _P	Power Gain	P _{OUT} = 1.0 W*	21	23	25	dB
η	Efficiency	P _{OUT} = 1.0 W*	11	12.5	—	%
—	Input VSWR	P _{OUT} = 1.0 W* Z _S , Z _L = 50Ω	—	—	1.5:1	VSWR
I _{CC(q)}	Quiescent Current	P _{IN} = 0 W	110	120	130	mA
I _{CC}	Collector Supply Current	P _{OUT} = 1.0 W*	—	375	425	mA
I _{BB}	Bias Current	P _{OUT} = 1.0 W*	—	65	—	mA
H	Harmonics	P _{OUT} = 1.0 W* F = 350 MHz	—	-34	-30	dBc
IMD	Intermodulation Distortion	P _{OUT} = 1.0 W*		-46	-40	dBc
—	Load Mismatch	Load VSWR = ∞:1 (All phase angles) P _{OUT} = 1.0 W*	No Degradation in Output Power after Load Restoration			
—	Stability	Load VSWR = 5:1 (All phase angles) P _{OUT} = 1.0 W*	All Spurious outputs more than 50dB below carrier			

* 2 Tone Test, 50 KHz spacing: P_{OUT} = 1.0 W_{AVG} (2.0 W_{PEP})

MODULE DC AND TEST FIXTURE CONFIGURATION

