

# FRD Type : TCU10A60

## OUTLINE DRAWING

For Power Factor Improvement High Frequency Rectification

### FEATURES

- \* Dual Diodes – Cathode Common
- \* Ultra – Fast Recovery
- \* Low Forward Voltage Drop
- \* High Surge Capability

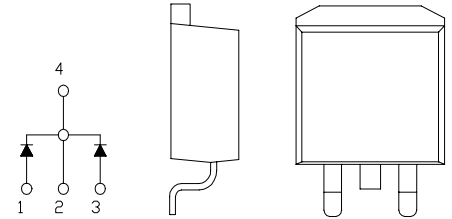

### Maximum Ratings

Approx Net Weight:1.45g

Rating	Symbol	TCU10A60		Unit
Repetitive Peak Reverse Voltage	$V_{RRM}$	600		V
Average Rectified Output Current	$I_O$	10	$T_c=84^\circ\text{C}$ 50 Hz, Full Sine Wave Resistive Load	A
RMS Forward Current	$I_{F(RMS)}$	11.1		A
Surge Forward Current	$I_{FSM}$	70	50 Hz Full Sine Wave, 1 cycle Non-repetitive	A
Operating Junction Temperature Range	$T_{jw}$	- 40 to + 150		$^\circ\text{C}$
Storage Temperature Range	$T_{stg}$	- 40 to + 150		$^\circ\text{C}$
Mounting torque		0.5	Recommended value	N•m

### Electrical • Thermal Characteristics

Characteristics	Symbol	Conditions	Min.	Typ.	Max.	Unit
Peak Reverse Current	$I_{RM}$	$T_j=25^\circ\text{C}, V_{RM}=V_{RRM}$ per Arm	-	-	30	$\mu\text{A}$
Peak Forward Voltage	$V_{FM}$	$T_j=25^\circ\text{C}, I_{FM}=5\text{A}$ per Arm	-	1.9	2.3	V
Reverse Recovery Time	$t_{rr}$	$I_{FM}=5\text{A}$ , $-di/dt=50\text{A}/\mu\text{s}$ , $T_a=25^\circ\text{C}$	-	25	35	ns
Thermal Resistance	$R_{th(j-c)}$	Junction to Case	-	-	3	$^\circ\text{C}/\text{W}$

C\_T\_ OUTLINE DRAWING (Dimensions in mm)



SOLDERING PAD

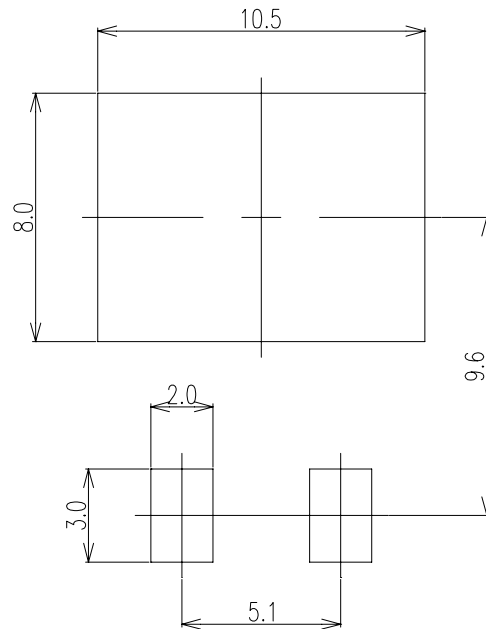

FORWARD CURRENT VS. VOLTAGE

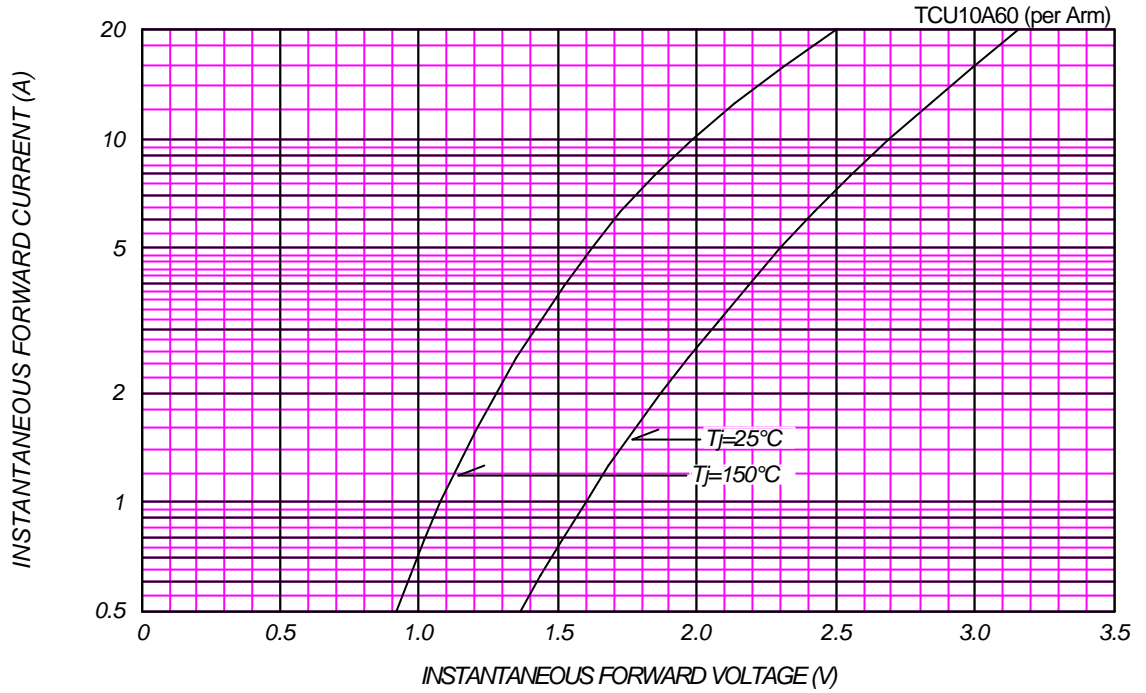

AVERAGE FORWARD POWER DISSIPATION

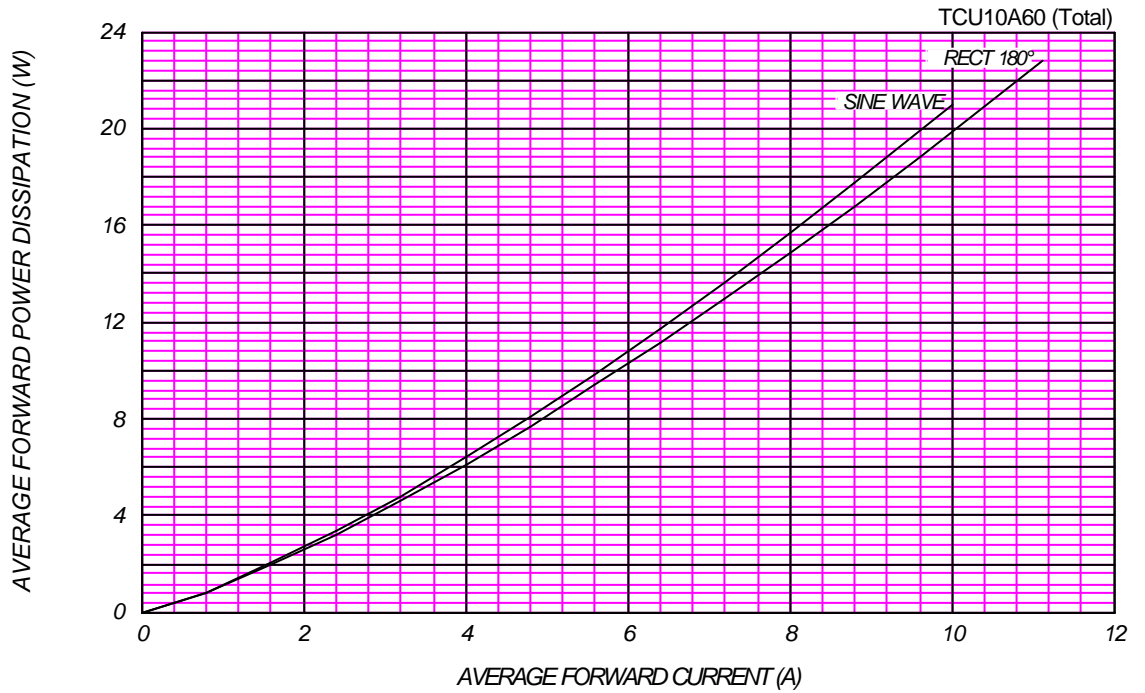

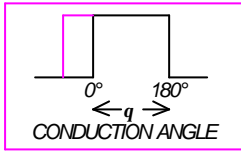

AVERAGE FORWARD CURRENT VS. CASE TEMPERATURE

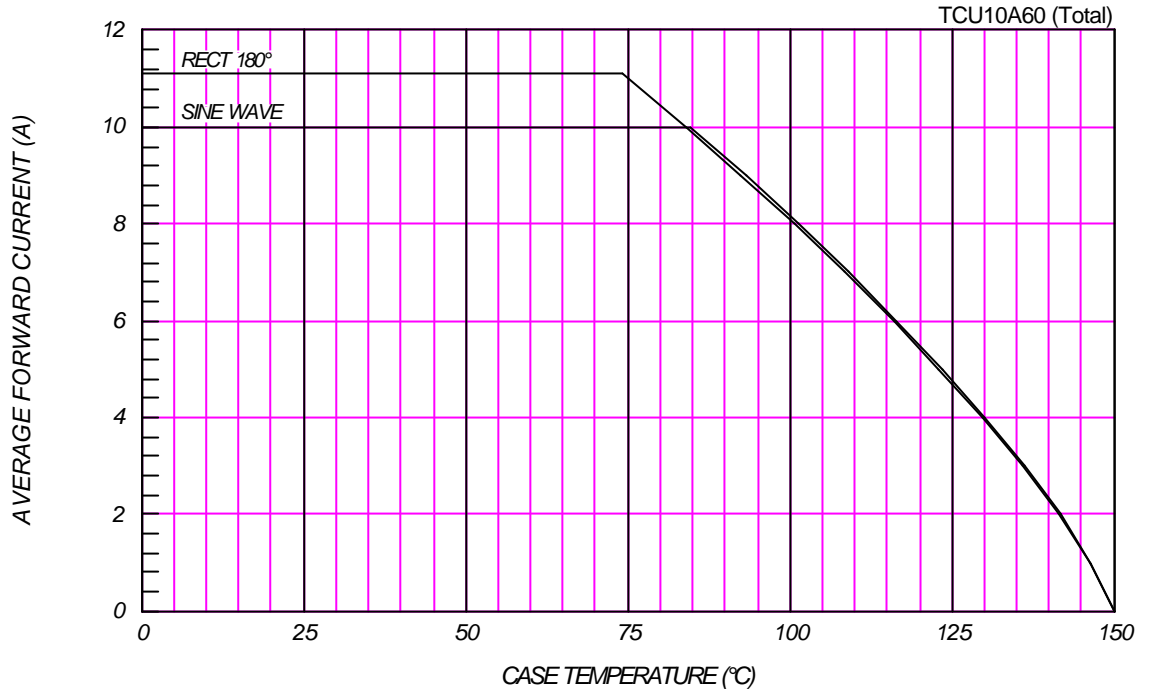

SURGE CURRENT RATINGS

f=50Hz, Sine Wave, Non-Repetitive, No Load

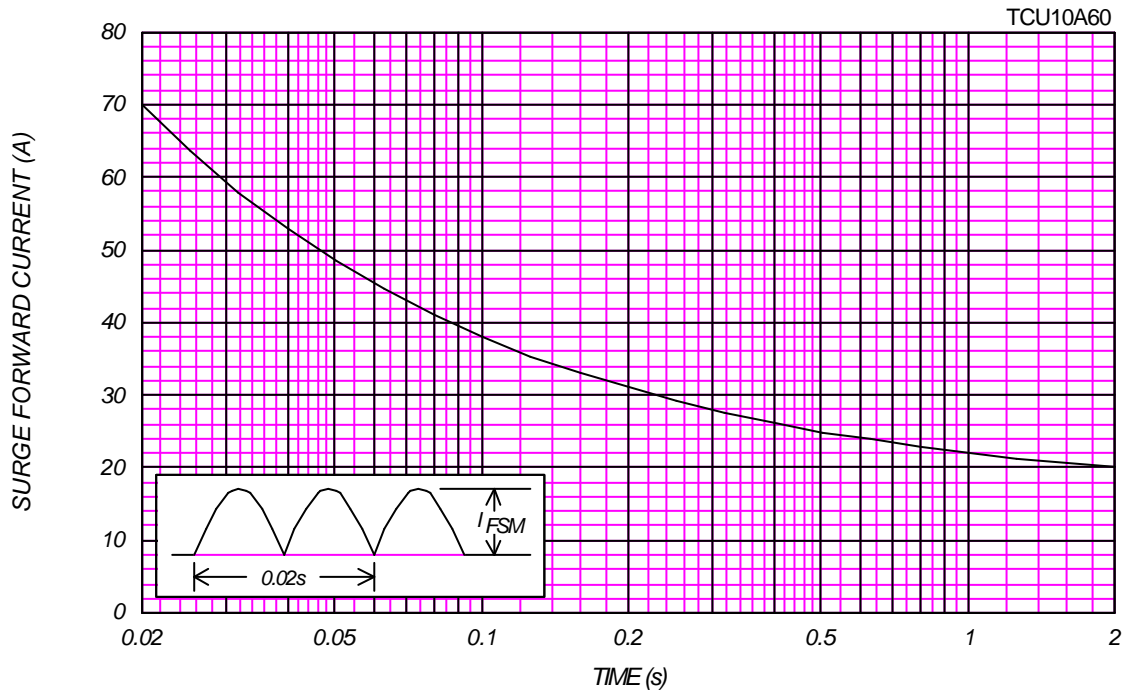

*RMS SURGE CURRENT RATINGS*

Ta=40°C, Non-Repetitive, No Load

TCU10A60

