**Netz-Thyristor-Modul**  
**Phase Control Thyristor Module**
**TT106N**
**TT106N**  
**TD106N..K..-A**
**TD106N**  
**TD106N..K..-K**
**DT106N**
**Elektrische Eigenschaften / Electrical properties**

Höchstzulässige Werte / Maximum rated values

Periodische Vorwärts- und Rückwärts-Spitzenspannung repetitive peak forward off-state and reverse voltages	$T_{vj} = -40^{\circ}\text{C} \dots T_{vj\text{ max}}$	$V_{\text{DRM}}, V_{\text{RRM}}$	1200 1600	1400 1800	V V
Vorwärts-Stoßspitzenspannung non-repetitive peak forward off-state voltage	$T_{vj} = -40^{\circ}\text{C} \dots T_{vj\text{ max}}$	$V_{\text{DSM}}$	1200 1600	1400 1800	V V
Rückwärts-Stoßspitzenspannung non-repetitive peak reverse voltage	$T_{vj} = +25^{\circ}\text{C} \dots T_{vj\text{ max}}$	$V_{\text{RSM}}$	1300 1700	1500 1900	V V
Durchlaßstrom-Grenzeffektivwert maximum RMS on-state current		$I_{\text{TRMSM}}$		180	A
Dauergrenzstrom average on-state current	$T_{\text{C}} = 85^{\circ}\text{C}$ $T_{\text{C}} = 78^{\circ}\text{C}$	$I_{\text{TAVM}}$		106 115	A A
Stoßstrom-Grenzwert surge current	$T_{vj} = 25^{\circ}\text{C}, t_p = 10\text{ ms}$ $T_{vj} = T_{vj\text{ max}}, t_p = 10\text{ ms}$	$I_{\text{TSM}}$		2250 2000	A A
Grenzlastintegral $I^2t$ -value	$T_{vj} = 25^{\circ}\text{C}, t_p = 10\text{ ms}$ $T_{vj} = T_{vj\text{ max}}, t_p = 10\text{ ms}$	$I^2t$		25300 20000	$\text{A}^2\text{s}$ $\text{A}^2\text{s}$
Kritische Stromsteilheit critical rate of rise of on-state current	DIN IEC 747-6 $f = 50\text{ Hz}$ , $i_{\text{GM}} = 0,6\text{ A}$ , $di_{\text{G}}/dt = 0,6\text{ A}/\mu\text{s}$	$(di_{\text{T}}/dt)_{\text{cr}}$		150	$\text{A}/\mu\text{s}$
Kritische Spannungssteilheit critical rate of rise of off-state voltage	$T_{vj} = T_{vj\text{ max}}, V_{\text{D}} = 0,67 V_{\text{DRM}}$ 6.Kennbuchstabe / 6 <sup>th</sup> letter F	$(dv_{\text{D}}/dt)_{\text{cr}}$		1000	$\text{V}/\mu\text{s}$

**Charakteristische Werte / Characteristic values**

Durchlaßspannung on-state voltage	$T_{vj} = T_{vj\text{ max}}, i_{\text{T}} = 300\text{ A}$	$V_{\text{T}}$	max.	1,78	V
Schleusenspannung threshold voltage	$T_{vj} = T_{vj\text{ max}}$	$V_{(\text{TO})}$		0,9	V
Ersatzwiderstand slope resistance	$T_{vj} = T_{vj\text{ max}}$	$r_{\text{T}}$		2,6	$\text{m}\Omega$
Zündstrom gate trigger current	$T_{vj} = 25^{\circ}\text{C}, V_{\text{D}} = 6\text{ V}$	$I_{\text{GT}}$	max.	150	$\text{mA}$
Zündspannung gate trigger voltage	$T_{vj} = 25^{\circ}\text{C}, V_{\text{D}} = 6\text{ V}$	$V_{\text{GT}}$	max.	1,4	V
Nicht zündender Steuerstrom gate non-trigger current	$T_{vj} = T_{vj\text{ max}}, V_{\text{D}} = 6\text{ V}$ $T_{vj} = T_{vj\text{ max}}, V_{\text{D}} = 0,5 V_{\text{DRM}}$	$I_{\text{GD}}$	max. max.	5,0 2,5	$\text{mA}$ $\text{mA}$
Nicht zündende Steuerspannung gate non-trigger voltage	$T_{vj} = T_{vj\text{ max}}, V_{\text{D}} = 0,5 V_{\text{DRM}}$	$V_{\text{GD}}$	max.	0,2	V
Haltestrom holding current	$T_{vj} = 25^{\circ}\text{C}, V_{\text{D}} = 6\text{ V}, R_{\text{A}} = 5\ \Omega$	$I_{\text{H}}$	max.	200	$\text{mA}$
Einraststrom latching current	$T_{vj} = 25^{\circ}\text{C}, V_{\text{D}} = 6\text{ V}, R_{\text{GK}} \geq 10\ \Omega$ $i_{\text{GM}} = 0,6\text{ A}$ , $di_{\text{G}}/dt = 0,6\text{ A}/\mu\text{s}$ , $t_{\text{g}} = 20\ \mu\text{s}$	$I_{\text{L}}$	max.	620	$\text{mA}$
Vorwärts- und Rückwärts-Sperrstrom forward off-state and reverse current	$T_{vj} = T_{vj\text{ max}}$ $V_{\text{D}} = V_{\text{DRM}}, V_{\text{R}} = V_{\text{RRM}}$	$i_{\text{D}}, i_{\text{R}}$	max.	30	$\text{mA}$
Zündverzug gate controlled delay time	DIN IEC 747-6 $T_{vj} = 25^{\circ}\text{C}$ , $i_{\text{GM}} = 0,6\text{ A}$ , $di_{\text{G}}/dt = 0,6\text{ A}/\mu\text{s}$	$t_{\text{gd}}$	max.	3	$\mu\text{s}$

prepared by:	C.Drilling	date of publication:	16.05.02
approved by:	J. Novotny	Revision:	2

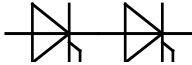

**Netz-Thyristor-Modul**  
**Phase Control Thyristor Module**
**TT106N**
**Elektrische Eigenschaften / Electrical properties**  
 Charakteristische Werte / Characteristic values

Freiwerdezeit circuit commutated turn-off time	$T_{vj} = T_{vj\max}$ , $i_{TM} = I_{TAVM}$ $V_{RM} = 100\text{ V}$ , $V_{DM} = 0,67 V_{DRM}$ $dv_D/dt = 20\text{ V}/\mu\text{s}$ , $-di_T/dt = 10\text{ A}/\mu\text{s}$ 5.Kennbuchstabe / 5 <sup>th</sup> letter O	$t_q$	typ.	150	$\mu\text{s}$
Isolations-Prüfspannung insulation test voltage	RMS, $f = 50\text{ Hz}$ , $t = 1\text{ min}$ RMS, $f = 50\text{ Hz}$ , $t = 1\text{ sec}$	$V_{ISOL}$		3,0 3,6	kV kV

**Thermische Eigenschaften / Thermal properties**

Innerer Wärmewiderstand thermal resistance, junction to case	pro Modul / per Module, $\Theta = 180^\circ\text{ sin}$ pro Zweig / per arm, $\Theta = 180^\circ\text{ sin}$ pro Modul / per Module, DC pro Zweig / per arm, DC	$R_{thJC}$	max.	0,165	$^\circ\text{C}/\text{W}$
			max.	0,330	$^\circ\text{C}/\text{W}$
			max.	0,155	$^\circ\text{C}/\text{W}$
			max.	0,310	$^\circ\text{C}/\text{W}$
Übergangs-Wärmewiderstand thermal resistance, case to heatsink	pro Modul / per Module pro Zweig / per arm	$R_{thCH}$	max.	0,04	$^\circ\text{C}/\text{W}$
			max.	0,08	$^\circ\text{C}/\text{W}$
Höchstzulässige Sperrschichttemperatur maximum junction temperature		$T_{vj\max}$		140	$^\circ\text{C}$
Betriebstemperatur operating temperature		$T_{c\text{ op}}$		-40...+140	$^\circ\text{C}$
Lagertemperatur storage temperature		$T_{stg}$		-40...+140	$^\circ\text{C}$

**Mechanische Eigenschaften / Mechanical properties**

Gehäuse, siehe Anlage case, see annex				Seite 3 Page 3	
Si-Element mit Druckkontakt Si-pellet with pressure contact					
Innere Isolation internal insulation				AIN	
Anzugsdrehmoment für mechanische Anschlüsse mounting torque	Toleranz / Tolerance $\pm 15\%$	M1		4	Nm
Anzugsdrehmoment für elektrische Anschlüsse terminal connection torque	Toleranz / Tolerance $\pm 10\%$	M2		4	Nm
Steueranschlüsse control terminals	DIN 46 244			A 2,8 x 0,8	
Gewicht weight		G	typ.	250	g
Kriechstrecke creepage distance				15	mm
Schwingfestigkeit vibration resistance	$f = 50\text{ Hz}$			50	$\text{m}/\text{s}^2$
	file-No.			E 83336	

Mit diesem Datenblatt werden Halbleiterbauelemente spezifiziert, jedoch keine Eigenschaften zugesichert. Es gilt in Verbindung mit den zugehörigen technischen Erläuterungen.

This data sheet specifies semiconductor devices, but promises no characteristics. It is valid in combination with the belonging technical notes.

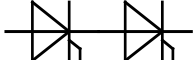

**Netz-Thyristor-Modul**  
Phase Control Thyristor Module

**TT106N**

screwing depth  
max. 8.5

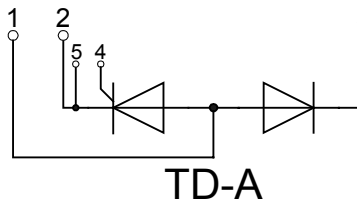
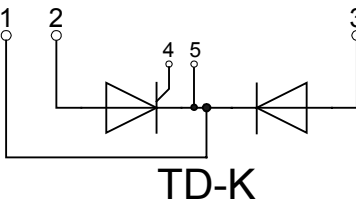
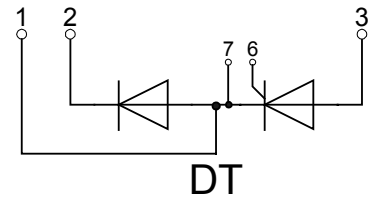
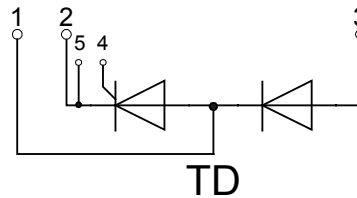
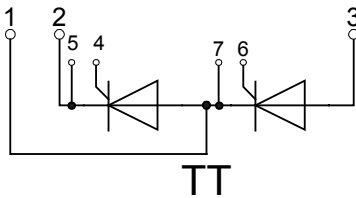
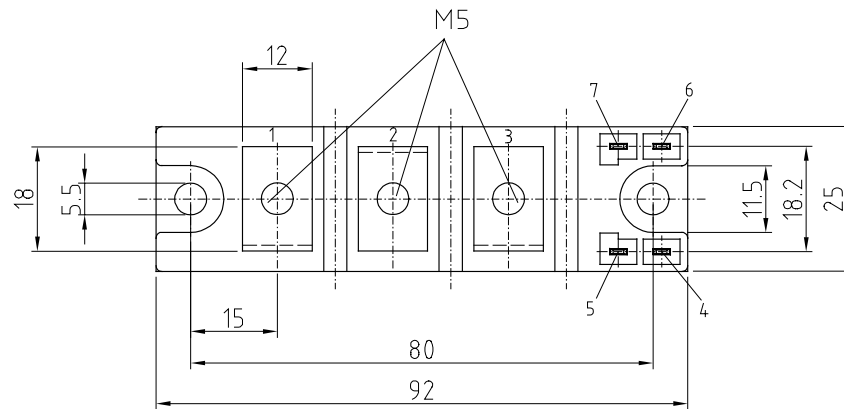
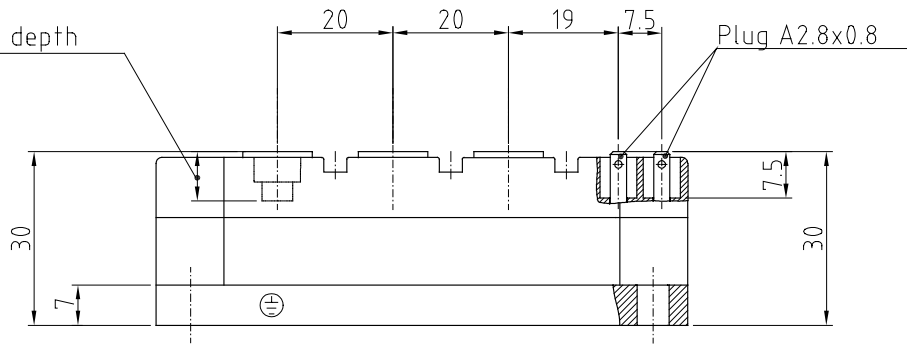

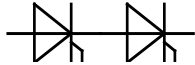

Netz-Thyristor-Modul  
Phase Control Thyristor Module

**TT106N**

**Analytische Elemente des transienten Wärmewiderstandes  $Z_{thJC}$  für DC**  
**Analytical elements of transient thermal impedance  $Z_{thJC}$  for DC**

Pos. n	1	2	3	4	5	6	7
$R_{thn}$ [°C/W]	0,0127	0,03	0,049	0,1682	0,0315		
$\tau_n$ [s]	0,001	0,0092	0,074	0,57	3,51		

Analytische Funktion / Analytical function: 
$$Z_{thJC} = \sum_{n=1}^{n_{max}} R_{thn} \left( 1 - e^{-\frac{t}{\tau_n}} \right)$$

Luftselbstkühlung / Natural cooling  
3 Module pro Kühlkörper / 3 modules per heatsink  
Kühlkörper / Heatsink type: KM14 (50W)

**Analytische Elemente des transienten Wärmewiderstandes  $Z_{thCA}$**   
**Analytical elements of transient thermal impedance  $Z_{thCA}$**

Pos. n	1	2	3	4	5	6	7
$R_{thn}$ [°C/W]	0,048	0,202	2,05				
$\tau_n$ [s]	3,71	40	984				

Verstärkte Kühlung / Forced cooling  
3 Module pro Kühlkörper / 3 modules per heatsink  
Kühlkörper / Heatsink type: KM 14 (Papst 4650N)

**Analytische Elemente des transienten Wärmewiderstandes  $Z_{thCA}$**   
**Analytical elements of transient thermal impedance  $Z_{thCA}$**

Pos. n	1	2	3	4	5	6	7
$R_{thn}$ [°C/W]	0,048	0,202	0,53				
$\tau_n$ [s]	3,71	40	254				

Analytische Funktion / Analytical function: 
$$Z_{thCA} = \sum_{n=1}^{n_{max}} R_{thn} \left( 1 - e^{-\frac{t}{\tau_n}} \right)$$

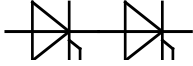

Netz-Thyristor-Modul  
Phase Control Thyristor Module

**TT106N**

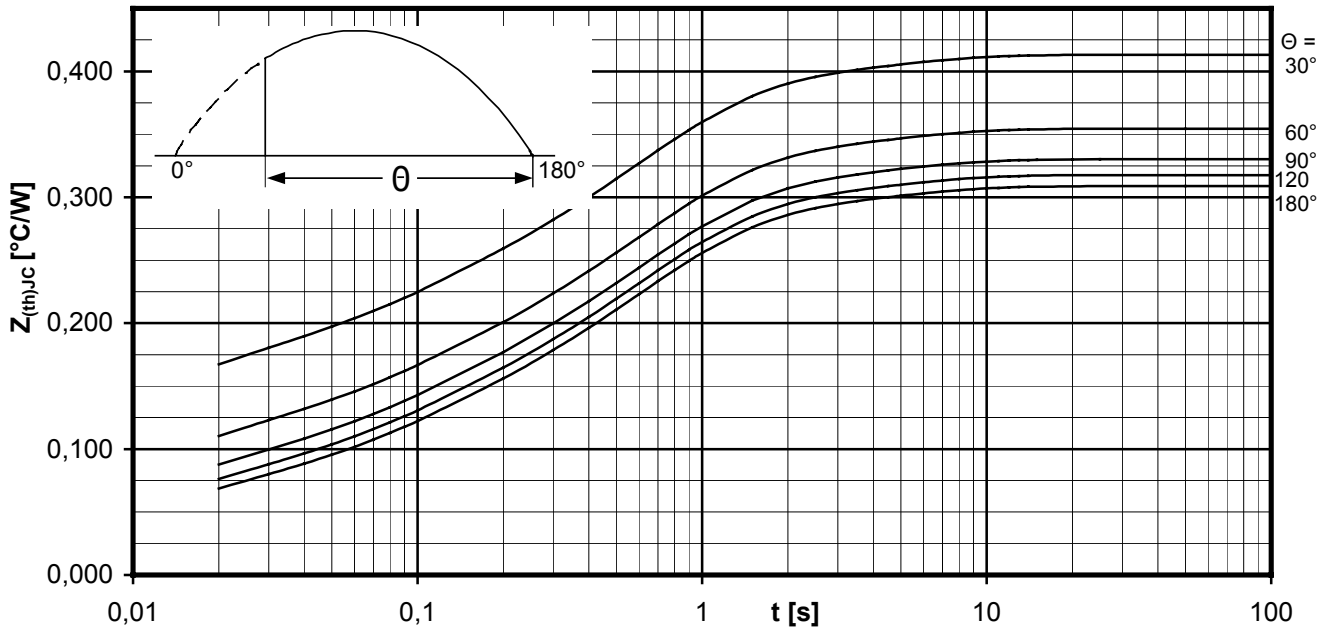

Transienter innerer Wärmewiderstand je Zweig / Transient thermal impedance per arm  $Z_{thJC} = f(t)$

Sinusförmiger Strom / Sinusoidal current

Parameter: Stromflußwinkel  $\Theta$  / Current conduction angle  $\Theta$

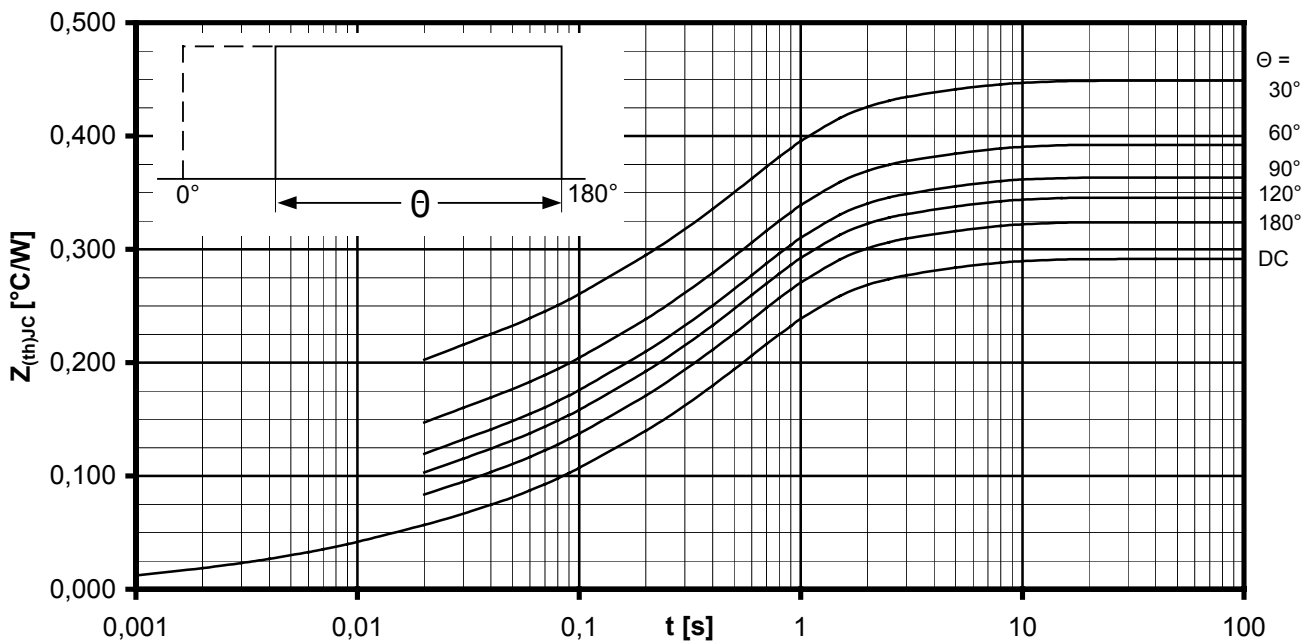

Transienter innerer Wärmewiderstand je Zweig / Transient thermal impedance per arm  $Z_{thJC} = f(t)$

Rechteckförmiger Strom / Rectangular current

Parameter: Stromflußwinkel  $\Theta$  / Current conduction angle  $\Theta$



Netz-Thyristor-Modul  
Phase Control Thyristor Module

**TT106N**

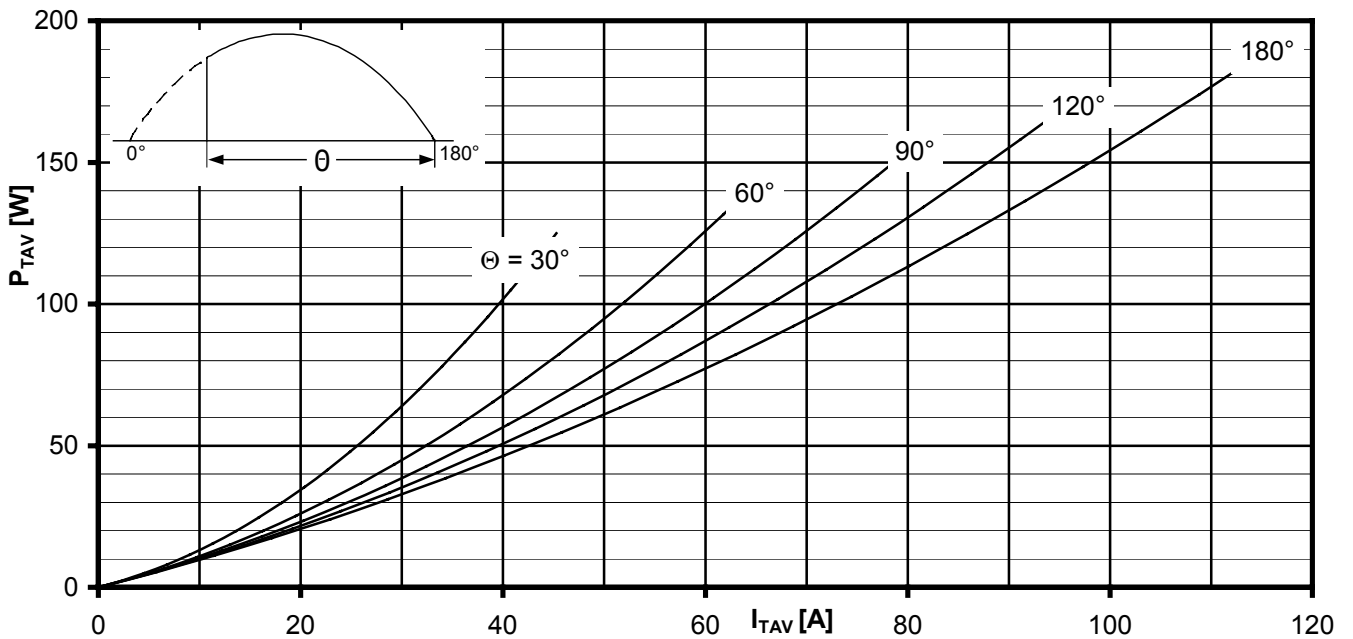

**Durchlassverlustleistung je Zweig / On-state power loss per arm  $P_{TAV} = f(I_{TAV})$**

Sinusförmiger Strom / Sinusoidal current    Strombelastung je Zweig / Current load per arm

Parameter: Stromflußwinkel / Current conduction angle  $\Theta$

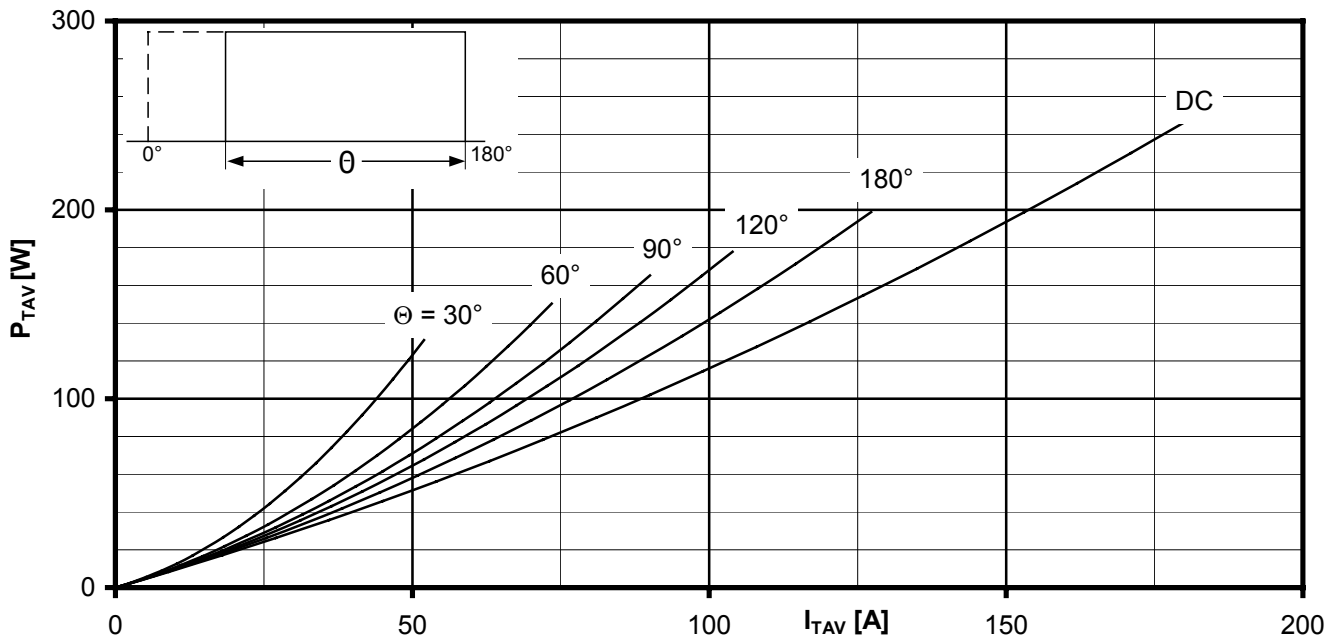

**Durchlassverlustleistung je Zweig / On-state power loss per arm  $P_{TAV} = f(I_{TAV})$**

Rechteckförmiger Strom / Rectangular current    Strombelastung je Zweig / Current load per arm

Parameter: Stromflußwinkel / Current conduction angle  $\Theta$

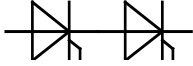

Netz-Thyristor-Modul  
Phase Control Thyristor Module

**TT106N**

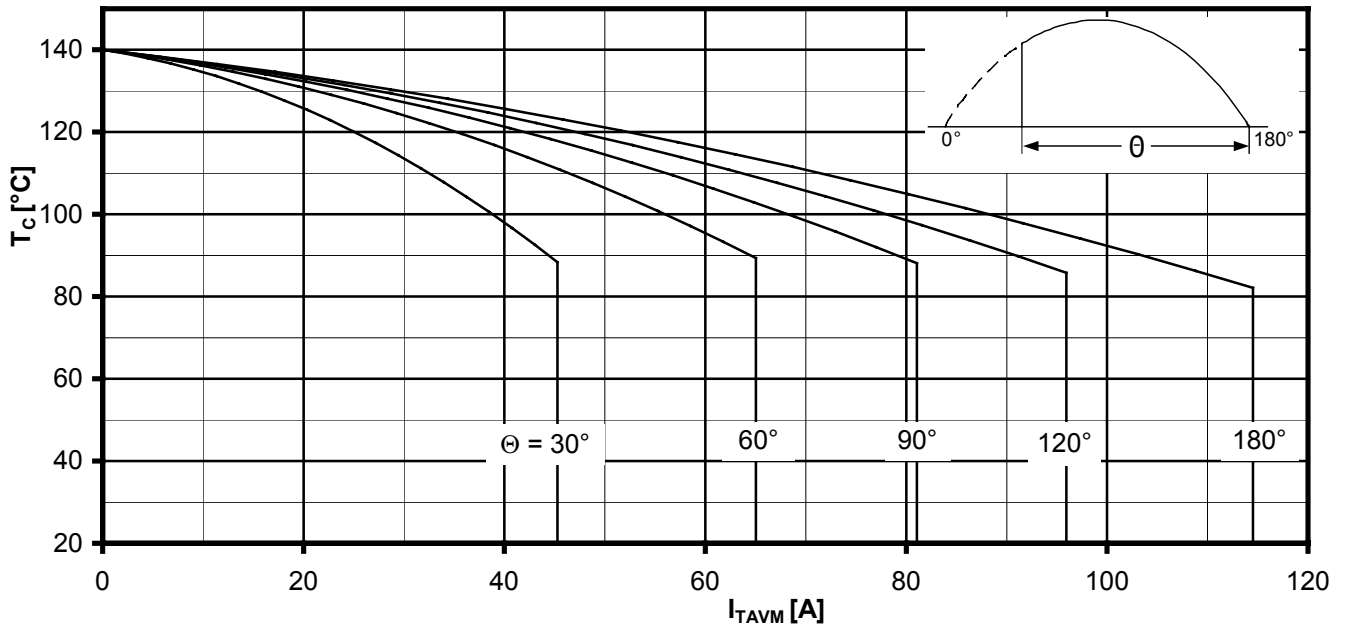

Höchstzulässige Gehäusetemperatur / Maximum allowable case temperature  $T_c = f(I_{TAVM})$

Sinusförmiger Strom / Sinusoidal current Strombelastung je Zweig / Current load per arm

Parameter: Stromflußwinkel  $\Theta$  / Current conduction angle  $\Theta$

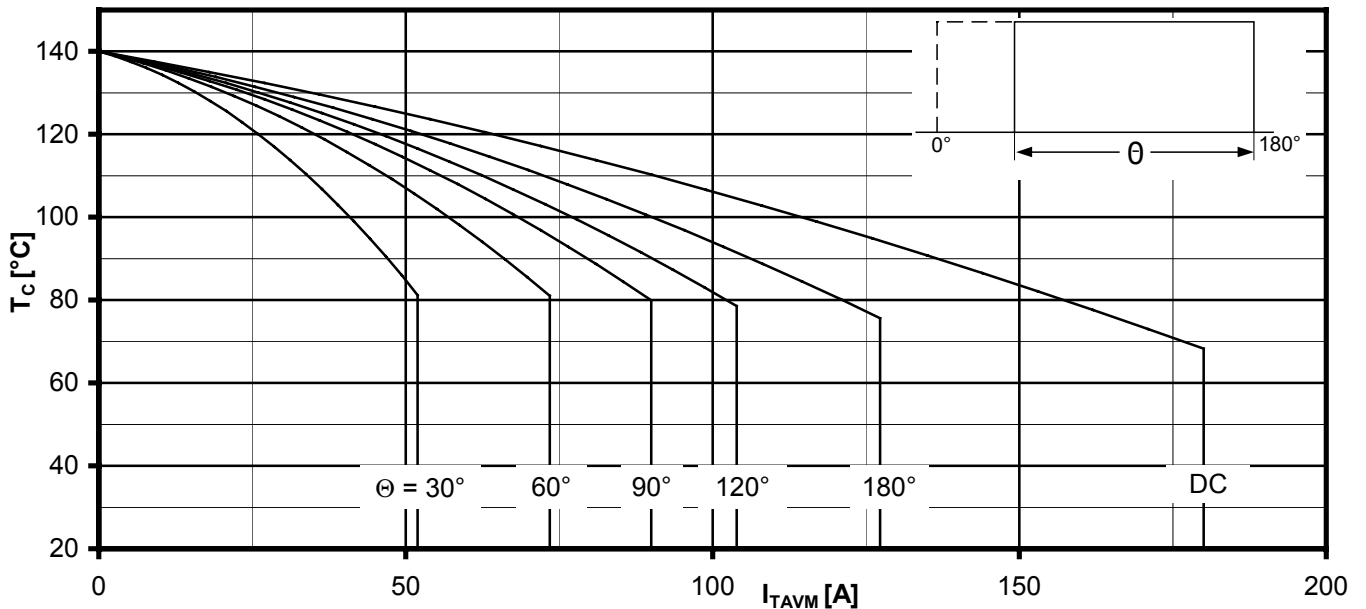

Höchstzulässige Gehäusetemperatur / Maximum allowable case temperature  $T_c = f(I_{TAVM})$

Rechteckförmiger Strom / Rectangular current Strombelastung je Zweig / Current load per arm

Parameter: Stromflußwinkel  $\Theta$  / Current conduction angle  $\Theta$

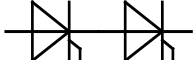

**Netz-Thyristor-Modul**  
Phase Control Thyristor Module

**TT106N**

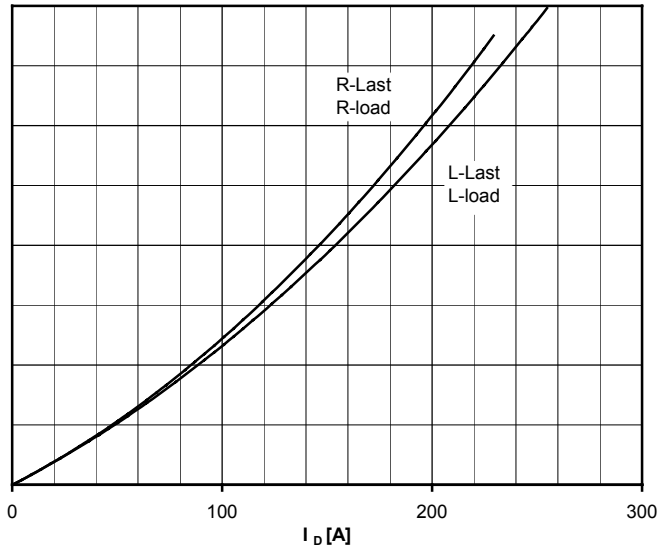
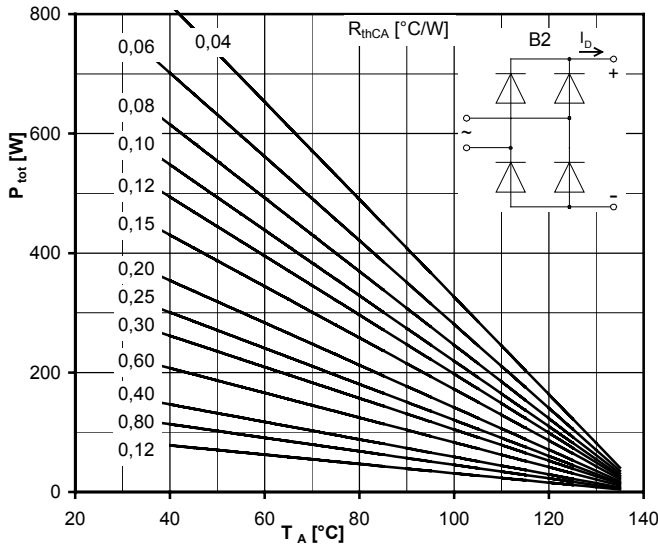

**Höchstzulässiger Ausgangsstrom / Maximum rated output current  $I_D$**

B2- Zweipuls-Brückenschaltung / Two-pulse bridge circuit

Gesamtverlustleistung der Schaltung / Total power dissipation at circuit  $P_{tot}$

Parameter:

Wärmewiderstand zwischen den Gehäusen und Umgebung / Thermal resistance cases to ambient  $R_{thCA}$

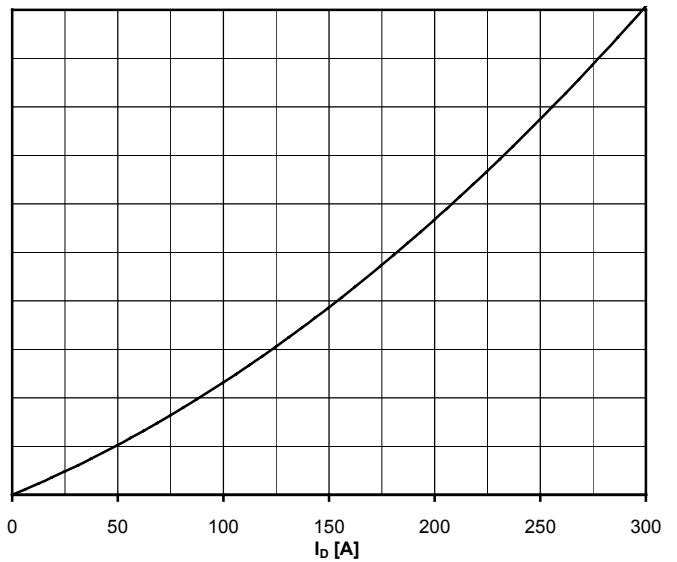
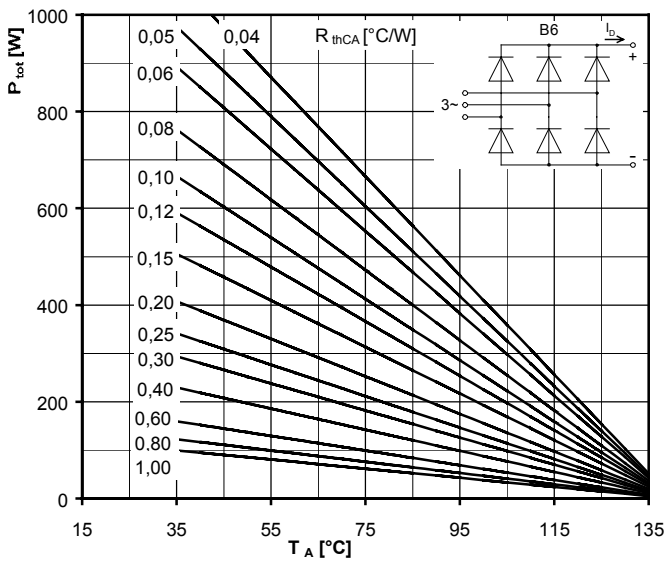

**Höchstzulässiger Ausgangsstrom / Maximum rated output current  $I_D$**

B6- Sechspuls-Brückenschaltung / Six-pulse bridge circuit

Gesamtverlustleistung der Schaltung / Total power dissipation at circuit  $P_{tot}$

Parameter:

Wärmewiderstand zwischen den Gehäusen und Umgebung / Thermal resistance cases to ambient  $R_{thCA}$



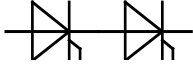

**Netz-Thyristor-Modul**  
**Phase Control Thyristor Module**

**TT106N**

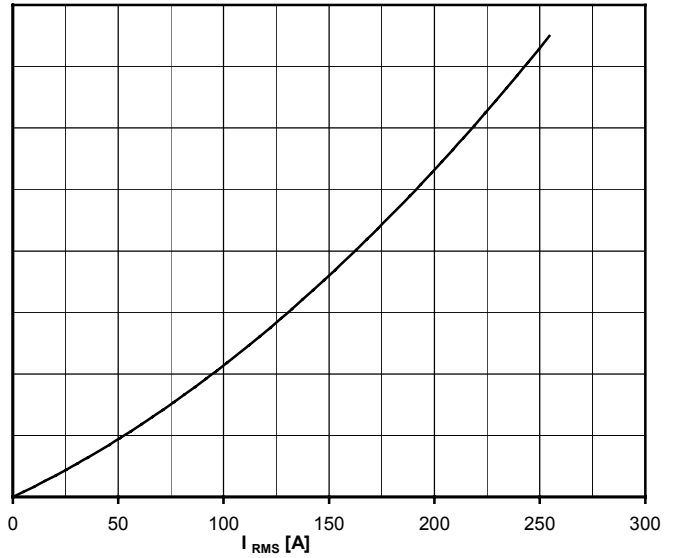
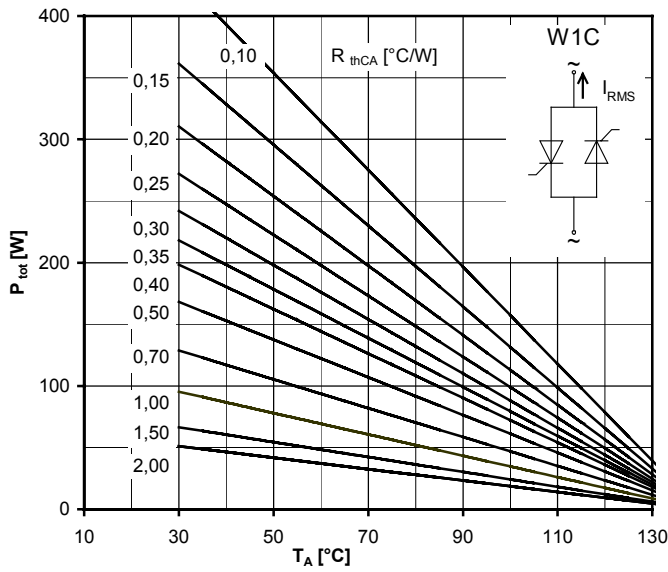

**Höchstzulässiger Effektivstrom / Maximum rated RMS current  $I_{RMS}$**

W1C - Einphasen-Wechselwegschaltung / Single-phase inverse parallel circuit

Gesamtverlustleistung der Schaltung / Total power dissipation at circuit  $P_{tot}$

Parameter:

Wärmewiderstand zwischen den Gehäusen und Umgebung / Thermal resistance case to ambient  $R_{thCA}$

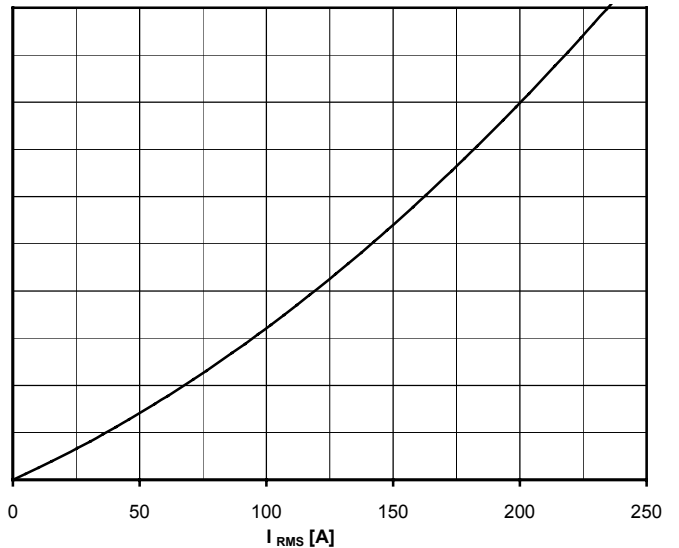
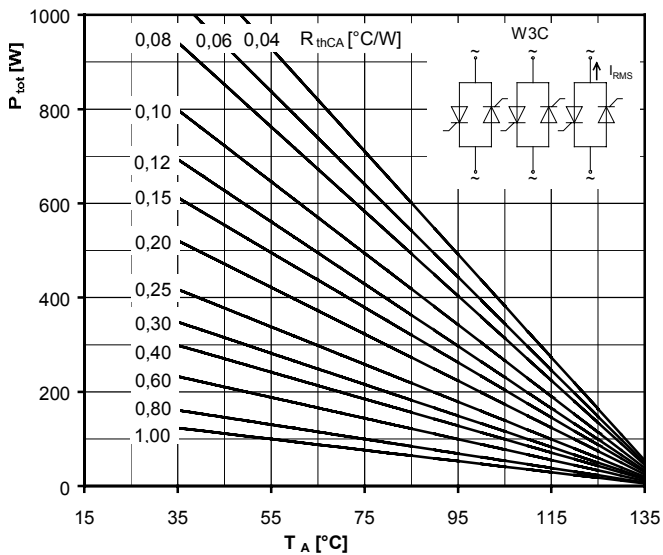

**Höchstzulässiger Effektivstrom / Maximum rated RMS current  $I_{RMS}$**

W3C - Dreiphasen-Wechselwegschaltung / Three-phase inverse parallel circuit

Gesamtverlustleistung der Schaltung / Total power dissipation at circuit  $P_{tot}$

Parameter:

Wärmewiderstand zwischen den Gehäusen und Umgebung / Thermal resistance cases to ambient  $R_{thCA}$

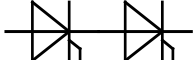

Netz-Thyristor-Modul  
Phase Control Thyristor Module

**TT106N**

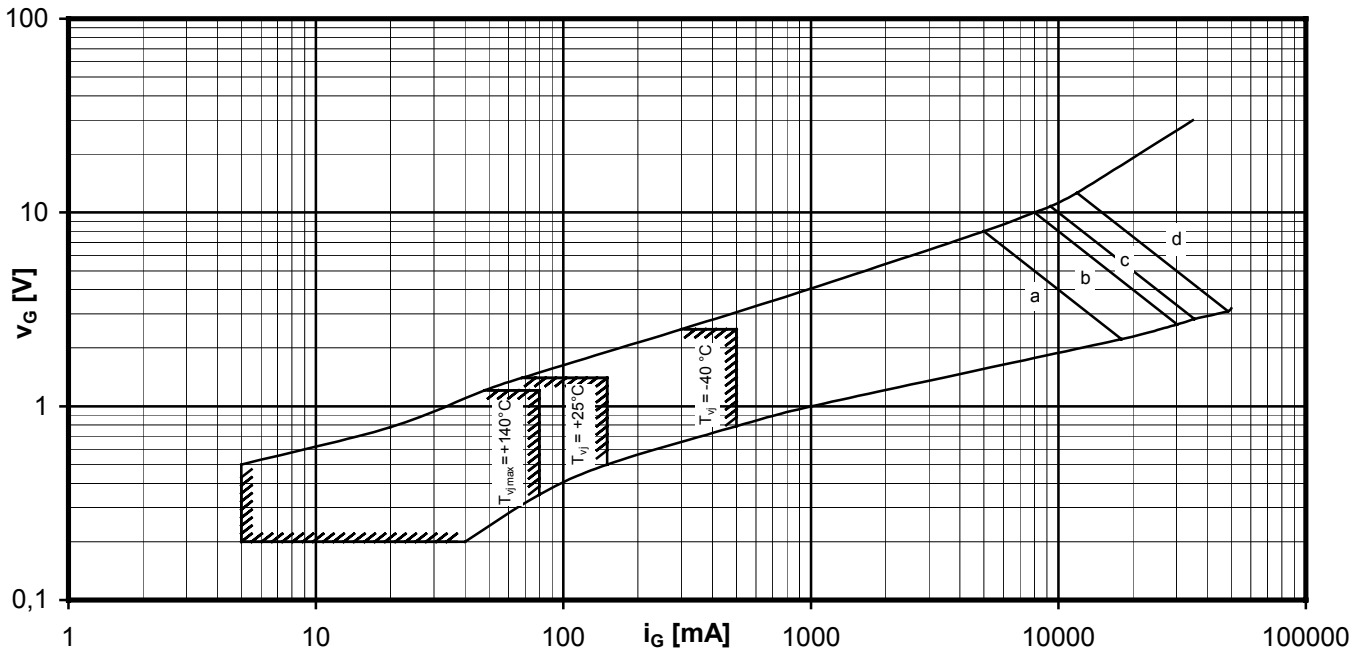

Steuercharakteristik  $v_G = f(i_G)$  mit Zündbereichen für  $V_D = 6\text{ V}$   
Gate characteristic  $v_G = f(i_G)$  with triggering area for  $V_D = 6\text{ V}$

Höchstzulässige Spitzensteuerverlustleistung / Maximum rated peak gate power dissipation  $P_{GM} = f(t_g)$  :

a - 40 W/10ms    b - 80 W/1ms    c - 100 W/0,5ms    d - 150W/0,1ms

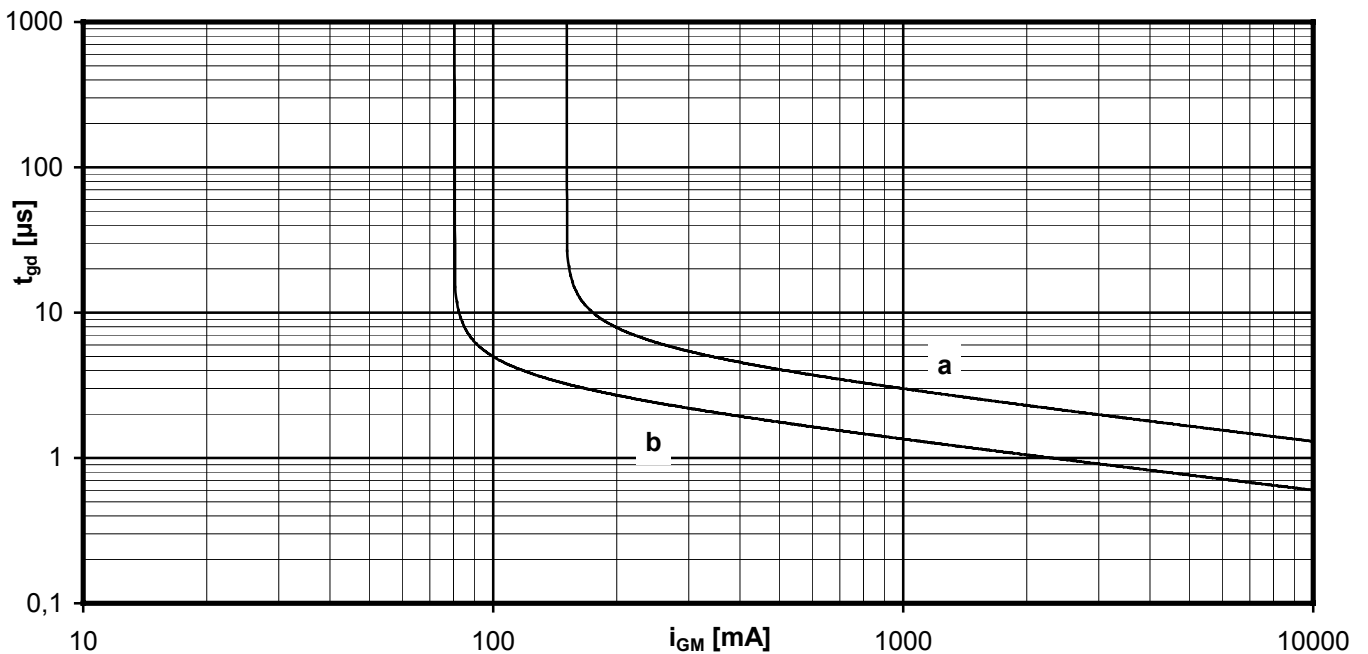

Zündverzug / Gate controlled delay time  $t_{gd} = f(i_G)$

$T_{vj} = 25^\circ\text{C}$ ,  $di_G/dt = i_{GM}/1\mu\text{s}$

a - maximaler Verlauf / Limiting characteristic

b - typischer Verlauf / Typical characteristic

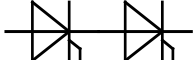

Netz-Thyristor-Modul  
Phase Control Thyristor Module

**TT106N**

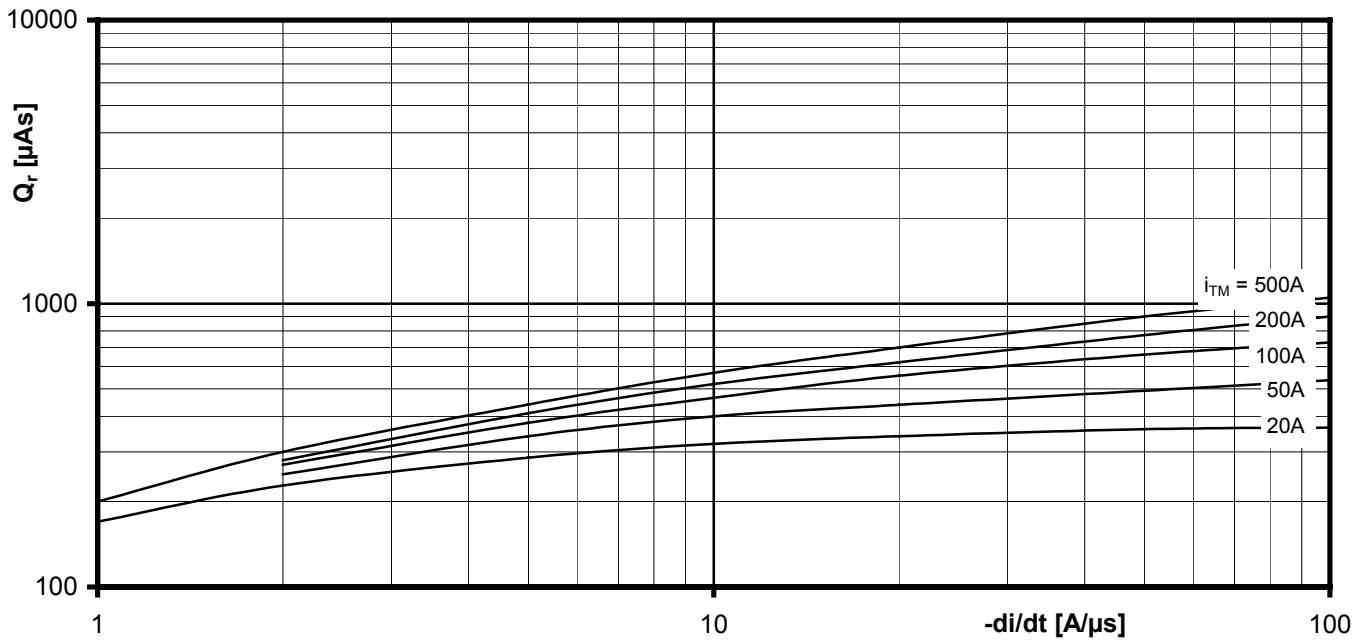

Sperrverzögerungsladung / Recovered charge  $Q_r = f(-di/dt)$

$$T_{vj} = T_{vjmax}, V_R \leq 0,5 V_{RRM}, V_{RM} = 0,8 V_{RRM}$$

Parameter: Durchlaßstrom / On-state current  $i_{TM}$

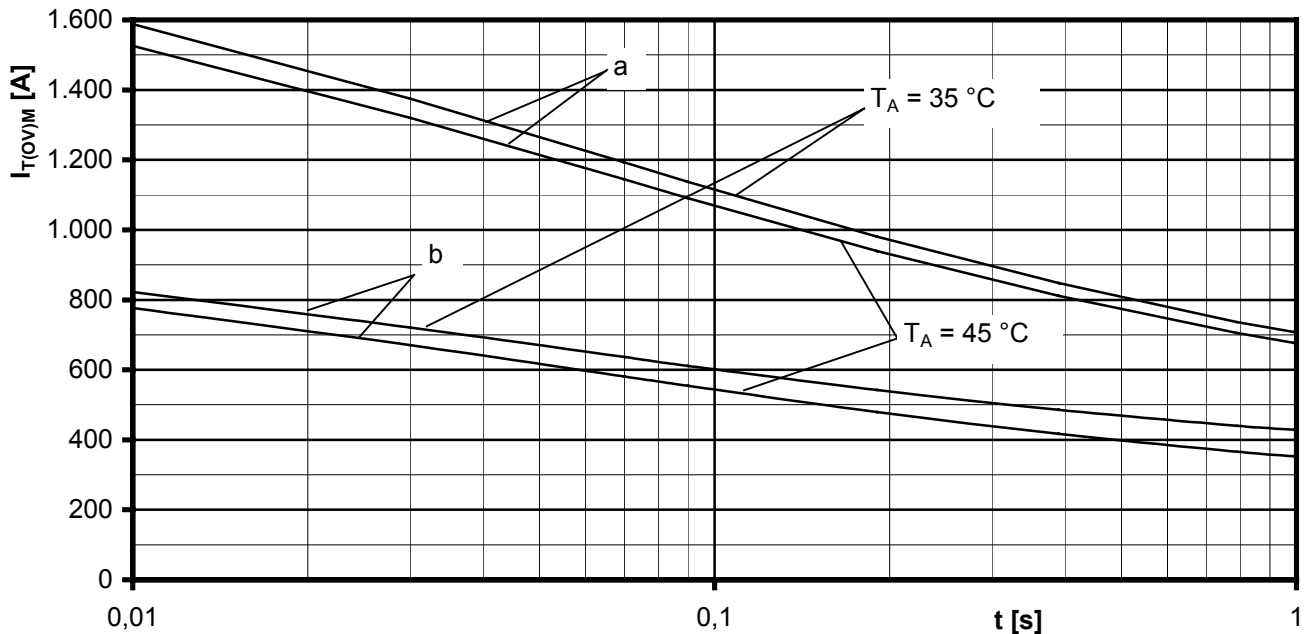

Grenzstrom / Maximum overload on-state current  $I_{T(OV)M} = f(t), v_{RM} = 0,8 V_{RRM}$

Leerlauf / No-load conditions

a:  $T_A = 35^\circ C$ , verstärkte Luftkühlung / Forced air cooling

b:  $T_A = 45^\circ C$ , Luftselbstkühlung / Natural air cooling



**Netz-Thyristor-Modul**  
Phase Control Thyristor Module

**TT106N**

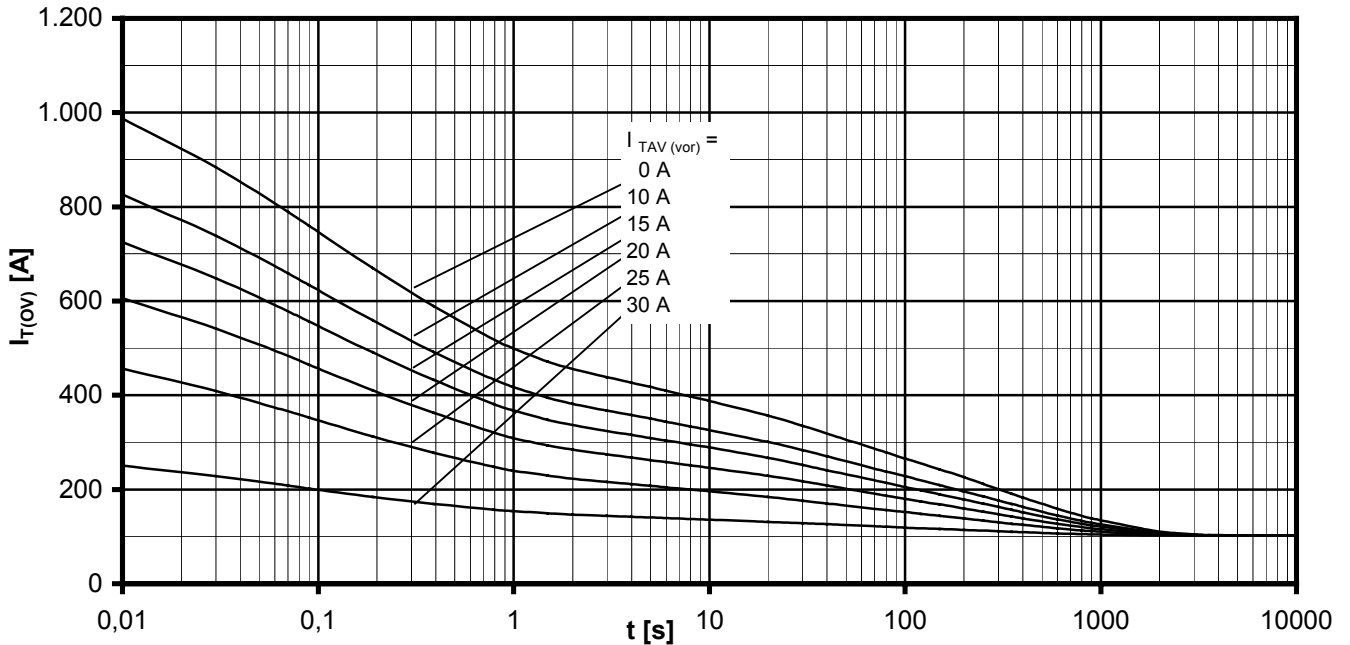

**Überstrom je Zweig / Overload on-state current  $I_{T(OV)}$**

B6- Sechspuls-Brückenschaltung, 120° Rechteck / Six-pulse bridge circuit, 120° rectangular

Kühlkörper / Heatsink type KM14 (50W) Luftselbstkühlung bei / Natural cooling at  $T_A = 45^\circ\text{C}$

Parameter: Vorlaststrom je Zweig / Pre-load current per arm  $I_{TAV(vor)}$

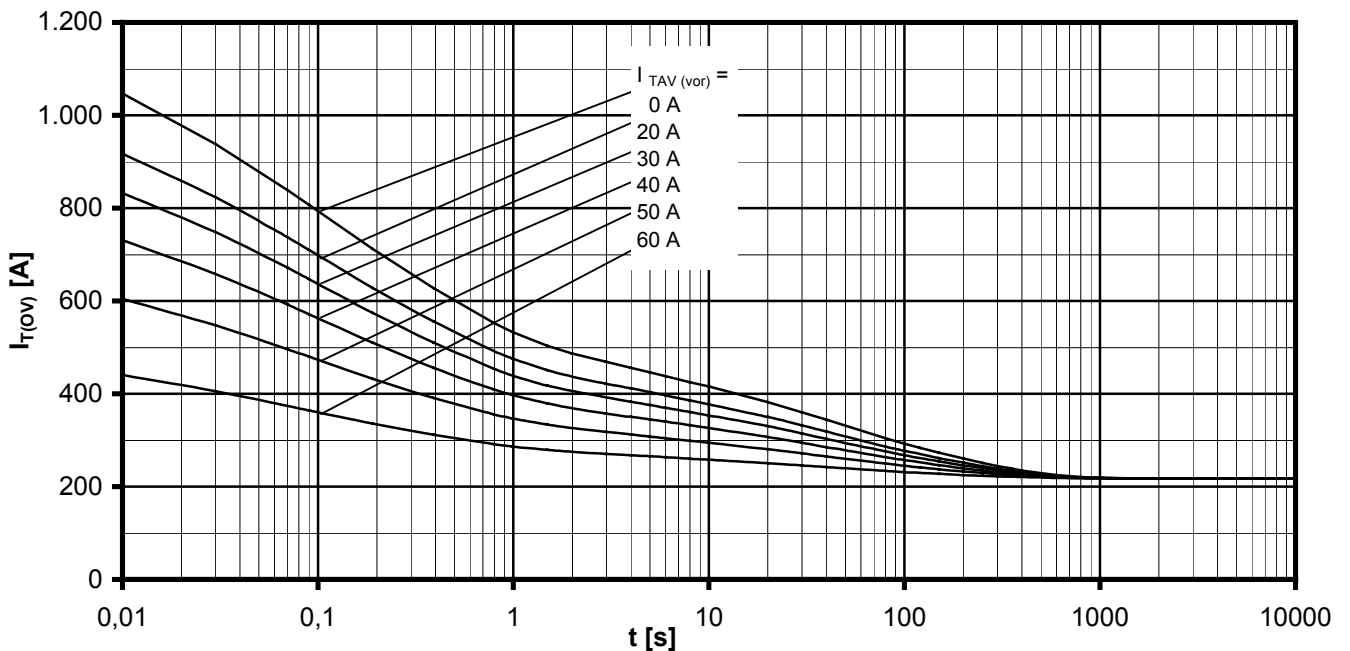

**Überstrom je Zweig / Overload on-state current  $I_{T(OV)}$**

B6- Sechspuls-Brückenschaltung, 120° Rechteck / Six-pulse bridge circuit, 120° rectangular

Kühlkörper / Heatsink type KM 14 (Papst 4650N) Verstärkte Kühlung bei / Forced cooling at  $T_A = 35^\circ\text{C}$

Parameter: Vorlaststrom je Zweig / Pre-load current per arm  $I_{TAV(vor)}$

## **Terms & Conditions of Usage**

### **Attention**

The present product data is exclusively subscribed to technically experienced staff. This Data Sheet is describing the specification of the products for which a warranty is granted exclusively pursuant the terms and conditions of the supply agreement. There will be no guarantee of any kind for the product and its specifications. Changes to the Data Sheet are reserved.

You and your technical departments will have to evaluate the suitability of the product for the intended application and the completeness of the product data with respect to such application. Should you require product information in excess of the data given in the Data Sheet, please contact your local Sales Office via "[www.eupec.com / sales & contact](http://www.eupec.com / sales & contact)".

### **Warning**

Due to technical requirements the products may contain dangerous substances. For information on the types in question please contact your local Sales Office via "[www.eupec.com / sales & contact](http://www.eupec.com / sales & contact)".