

High transition frequency (dual transistors)

EMX5 / UMX5N / IMX5

●Features

- 1) Two 2SC3838K chips in a EMT or UMT or SMT package.
- 2) High transition frequency. ($f_T=3.2\text{GHz}$)
- 3) Low output capacitance. ($C_{ob}=0.9\text{pF}$)

●Equivalent circuits

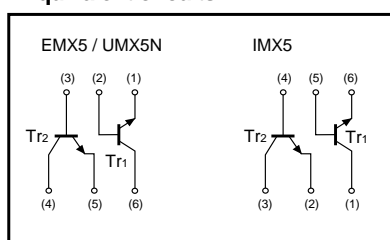

●Absolute maximum ratings ($T_a=25^\circ\text{C}$)

Parameter	Symbol	Limits	Unit
Collector-base voltage	V_{CB0}	20	V
Collector-emitter voltage	V_{CEO}	11	V
Emitter-base voltage	V_{EBO}	3	V
Collector current	I_c	50	mA
Collector power dissipation	EMX5 / UMX5N	150(TOTAL)	mW *1
	IMX5	300(TOTAL)	mW *2
Junction temperature	T_j	150	$^\circ\text{C}$
Storage temperature	T_{stg}	-55 to +150	$^\circ\text{C}$

*1 120mW per element must not be exceeded.

*2 200mW per element must not be exceeded.

●Package, marking, and packaging specifications

Type	EMX5	UMX5N	IMX5
Package	EMT5	UMT6	SMT6
Marking	X5	X5	X5
Code	T2R	TR	T108
Basic ordering unit (pieces)	8000	3000	3000

●External dimensions (Unit : mm)

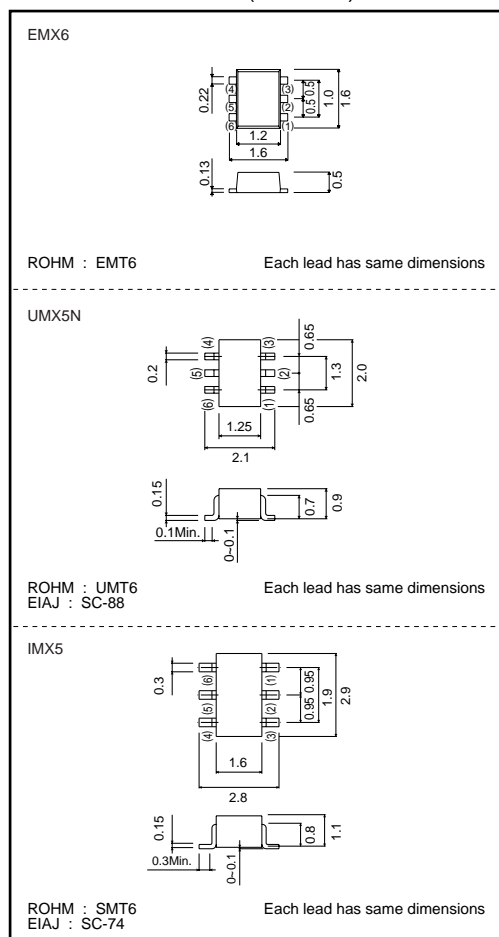

Transistors

●Electrical characteristics (Ta=25°C)

Parameter	Symbol	Min.	Typ.	Max.	Unit	Conditions
Collector-base breakdown voltage	BV _{CBO}	20	–	–	V	I _C =10μA
Collector-emitter breakdown voltage	BV _{CEO}	11	–	–	V	I _C =1mA
Emitter-base breakdown voltage	BV _{EBO}	3	–	–	V	I _E =10μA
Collector cutoff current	I _{CBO}	–	–	0.5	μA	V _{CB} =10V
Emitter cutoff current	I _{EBO}	–	–	0.5	μA	V _{EB} =2V
DC current transfer ratio	h _{FE}	56	–	120	–	V _{CE} /I _C =10V/5mA
Collector-emitter saturation voltage	V _{CE(sat)}	–	–	0.5	V	I _C /I _B =10mA/5mA
Transition frequency	f _T	1.4	3.2	–	GHz	V _{CE} /I _E =10V/-10mA, f=500MHz *
Output capacitance	C _{ob}	–	0.9	1.55	pF	V _{CB} /f=10V/1MHz, I _E =0A

*Transition frequency of the device.

●Electrical characteristics curves

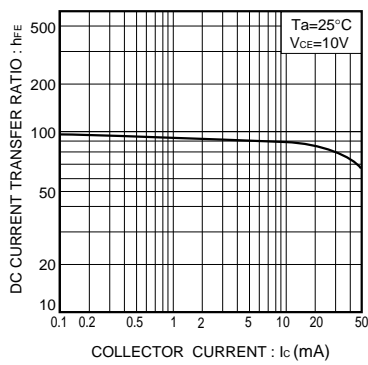

Fig.1 DC current gain vs. collector current

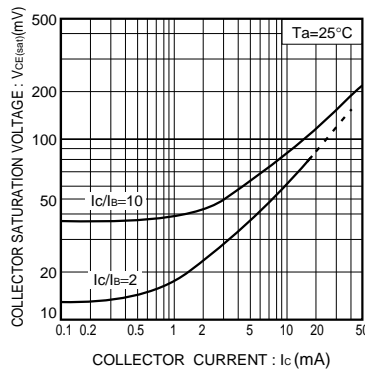

Fig.2 Collector-emitter saturation voltage vs. collector current

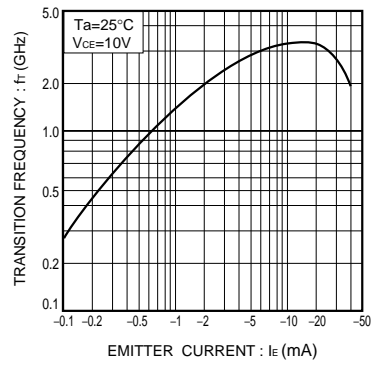

Fig.3 Gain bandwidth product vs. emitter current

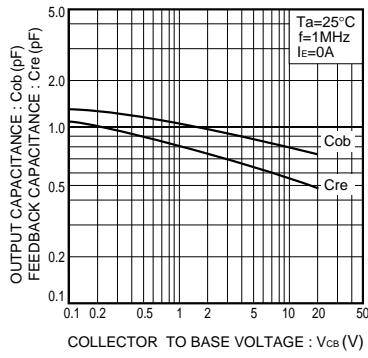

Fig.4 Capacitance vs. reverse bias voltage

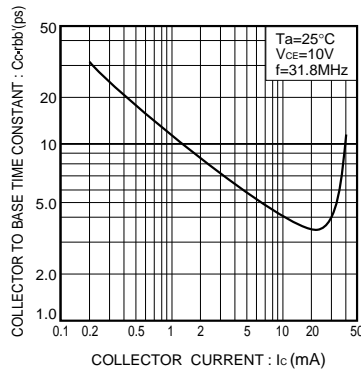

Fig.5 Collector to base time constant vs. collector current characteristics

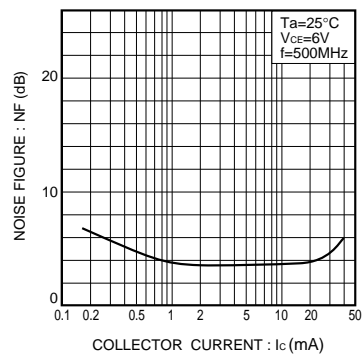

Fig.6 Noise factor vs. collector current characteristics

Notes

- No technical content pages of this document may be reproduced in any form or transmitted by any means without prior permission of ROHM CO.,LTD.
- The contents described herein are subject to change without notice. The specifications for the product described in this document are for reference only. Upon actual use, therefore, please request that specifications to be separately delivered.
- Application circuit diagrams and circuit constants contained herein are shown as examples of standard use and operation. Please pay careful attention to the peripheral conditions when designing circuits and deciding upon circuit constants in the set.
- Any data, including, but not limited to application circuit diagrams information, described herein are intended only as illustrations of such devices and not as the specifications for such devices. ROHM CO.,LTD. disclaims any warranty that any use of such devices shall be free from infringement of any third party's intellectual property rights or other proprietary rights, and further, assumes no liability of whatsoever nature in the event of any such infringement, or arising from or connected with or related to the use of such devices.
- Upon the sale of any such devices, other than for buyer's right to use such devices itself, resell or otherwise dispose of the same, no express or implied right or license to practice or commercially exploit any intellectual property rights or other proprietary rights owned or controlled by
- ROHM CO., LTD. is granted to any such buyer.
- Products listed in this document are no antiradiation design.

The products listed in this document are designed to be used with ordinary electronic equipment or devices (such as audio visual equipment, office-automation equipment, communications devices, electrical appliances and electronic toys).

Should you intend to use these products with equipment or devices which require an extremely high level of reliability and the malfunction of which would directly endanger human life (such as medical instruments, transportation equipment, aerospace machinery, nuclear-reactor controllers, fuel controllers and other safety devices), please be sure to consult with our sales representative in advance.

About Export Control Order in Japan

Products described herein are the objects of controlled goods in Annex 1 (Item 16) of Export Trade Control Order in Japan.

In case of export from Japan, please confirm if it applies to "objective" criteria or an "informed" (by MITI clause) on the basis of "catch all controls for Non-Proliferation of Weapons of Mass Destruction.