

Sup/IRBuck™

HIGHLY INTEGRATED 4A

WIDE-INPUT VOLTAGE, SYNCHRONOUS BUCK REGULATOR

Features

- Wide Input Voltage Range 2.5V to 21V
- Wide Output Voltage Range 0.6V to 12V
- Continuous 4A Load Capability
- 600kHz High Frequency Operation
- Programmable Over-Current-Protection
- Hiccup Current Limit
- Tracking capability for Memory Application
- Precision Reference Voltage (0.6V)
- Programmable Soft-Start
- Pre-Bias Start-up
- Thermal Protection
- Thermally Enhanced Package
- Small Size 5mmx6mm QFN
- Pb-Free (RoHS Compliant)

Applications

- Distributed Point-of-Loads
- Server and Workstations
- Embedded Systems
- Storage Systems
- DDR Applications
- Graphics Cards
- Game Consoles
- Computing Peripheral Voltage Regulators

Description

The IR3812 **Sup/IRBuck™** is an easy-to-use, fully integrated and highly efficient DC/DC regulator. The onboard switching controller and MOSFETs make the IR3812 a space-efficient solution, providing accurate power delivery for low output voltage applications.

The IR3812 operates from a 4.5V to 14V input supply and generates an output voltage adjustable from 0.6V to $0.80 \cdot V_{in}$ at loads up to 4A.

IR3812 can be configured for tracking applications to generate termination voltage (VTT) for memory applications.

A versatile regulator offering programmability of start up time and current limit, the IR3812's fixed 600kHz switching frequency allows the use of small external components.

IR3812 also features important protection functions, such as Pre-Bias startup, hiccup current limit and thermal shutdown to provide the required system level security in the event of fault conditions.

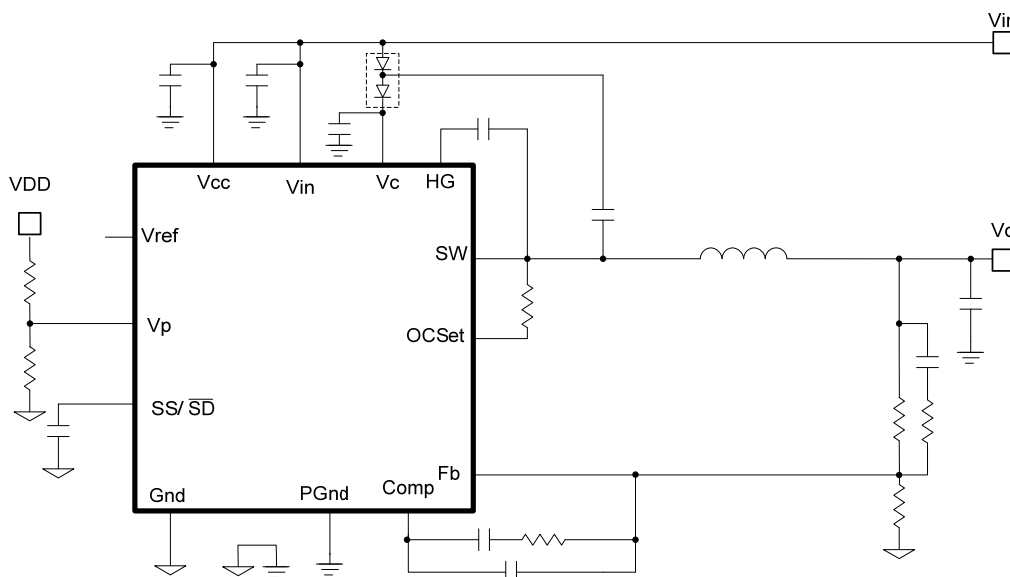

Fig. 1. Typical application diagram