

TOSHIBA Photocoupler GaAs Ired & Photo-Thyristor

TLP747G

- Office Machine
- Household Use Equipment
- Solid State Relay
- Switching Power Supply

The TOSHIBA TLP747G consists of a photo-thyristor optically coupled to a gallium arsenide infrared emitting diode in a six lead plastic DIP.

- Peak off-state voltage: 400 V (min.)
- Trigger LED current: 15 mA (max.)
- On-state current: 150 mA (max.)
- UL recognized: UL1577, file No. E67349
- BSI approved: BS EN60065: 2002
Certificate No. 7364
BS EN60950-1: 2002
Certificate No. 7365
- SEMCO approved: EN60065, EN60950-1, EN60335-1
Certificate no. 302586
- Isolation voltage: 4000 Vrms (min.)
- Option (D4) type
VDE approved: DIN EN 60747-5-2,
Certificate No. 40009373
Maximum operating insulation voltage: 630, 890 VPK
Highest permissible over voltage: 6000, 8000 VPK

(Note) When a EN 60747-5-2 approved type is needed, please designate the "option (D4)"

	7.62mm pich standard type	10.16mm pich TLPxxxF type
• Creepage distance	: 7.0mm (min.)	8.0mm (min.)
Clearance	: 7.0mm (min.)	8.0mm (min.)
Insulation thickness	: 0.5mm (min.)	0.5mm (min.)

Unit in mm

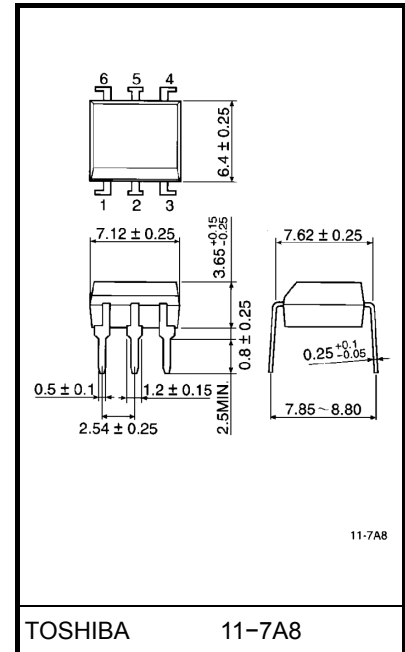

Weight: 0.42 g

Pin Configuration (top view)

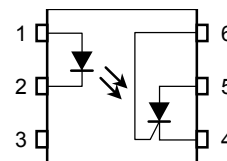

- 1 : Anode
- 2 : Cathode
- 3 : NC
- 4 : Cathode
- 5 : Anode
- 6 : Gate

Absolute Maximum Ratings (Ta = 25°C)

Characteristic		Symbol	Rating	Unit
LED	Forward current	I_F	60	mA
	Forward current derating (Ta ≥ 39°C)	$\Delta I_F / ^\circ\text{C}$	-0.7	mA / °C
	Peak forward current (100µs pulse, 100pps)	I_{FP}	1	A
	Reverse voltage	V_R	5	V
	Junction temperature	T_j	125	°C
Detector	Peak forward voltage (RGK = 27kΩ)	V_{DRM}	400	V
	Peak reverse voltage (RGK = 27kΩ)	V_{RRM}	400	V
	On-state current	$I_{T(RMS)}$	150	mA
	On-state current derating (Ta ≥ 25°C)	$\Delta I_T / ^\circ\text{C}$	-2.0	mA / °C
	Peak on-state current (100 µs pulse, 120pps)	I_{TP}	3	A
	Peak one cycle surge current	I_{TSM}	2	A
	Peak reverse gate voltage	V_{GM}	5	V
	Power dissipation	P_D	150	mW
	Power dissipation derating (Ta ≥ 25°C)	$\Delta P_D / ^\circ\text{C}$	-2.0	mW / °C
	Junction temperature	T_j	100	°C
Storage temperature range		T_{stg}	-55~125	°C
Operating temperature range		T_{opr}	-40~100	°C
Lead soldering temperature (10s)		T_{sol}	260	°C
Total package power dissipation		P_T	250	mW
Total package power dissipation derating (Ta ≥ 25°C)		$\Delta P_T / ^\circ\text{C}$	-3.3	mW / °C
Isolation voltage (AC, 1min., R.H. ≤ 60%) (Note)		BV_S	4000	Vrms

Note: Using continuously under heavy loads (e.g. the application of high temperature/current/voltage and the significant change in temperature, etc.) may cause this product to decrease in the reliability significantly even if the operating conditions (i.e. operating temperature/current/voltage, etc.) are within the absolute maximum ratings.

Please design the appropriate reliability upon reviewing the Toshiba Semiconductor Reliability Handbook ("Handling Precautions"/"Derating Concept and Methods") and individual reliability data (i.e. reliability test report and estimated failure rate, etc).

(Note) Device considered a two terminal device: Pins 1, 2 and 3 shorted together, and pins 4, 5 and 6 shorted together.

Recommended Operating Conditions

Characteristic	Symbol	Min.	Typ.	Max.	Unit
Supply voltage	V_{AC}	—	—	120	Vac
Forward current	I_F	20	—	25	mA
Operating temperature	T_{opr}	-25	—	85	°C
Gate to cathode resistance	R_{GK}	—	27	33	kΩ
Gate to cathode capacity	C_{GK}	—	0.01	0.1	µF

Note: Recommended operating conditions are given as a design guideline to obtain expected performance of the device. Additionally, each item is an independent guideline respectively. In developing designs using this product, please confirm specified characteristics shown in this document.

Individual Electrical Characteristics (Ta = 25°C)

Characteristic		Symbol	Test Condition	Min.	Typ.	Max.	Unit	
LED	Forward voltage	V_F	$I_F = 10\text{mA}$	1.0	1.15	1.3	V	
	Reverse current	I_R	$V_R = 5\text{V}$	—	—	10	μA	
	Capacitance	C_T	$V = 0, f = 1\text{MHz}$	—	30	—	pF	
Detector	Off-state current	I_{DRM}	$V_{AK} = 400\text{V}$ $R_{GK} = 27\text{k}\Omega$	Ta = 25°C	—	10	5000	nA
				Ta = 100°C	—	1	100	μA
	Reverse current	I_{RRM}	$V_{KA} = 400\text{V}$ $R_{GK} = 27\text{k}\Omega$	Ta = 25°C	—	10	5000	nA
				Ta = 100°C	—	1	100	μA
	On-state voltage	V_{TM}	$I_{TM} = 100\text{mA}$	—	0.9	1.3	V	
	Holding current	I_H	$R_{GK} = 27\text{k}\Omega$	—	0.2	—	mA	
	Off-state dv / dt	dv / dt	$V_{AK} = 280\text{V}, R_{GK} = 27\text{k}\Omega$	5	10	—	V / μs	
Capacitance	C_j	$V = 0,$ $f = 1\text{MHz}$	Anode to gate	—	20	—	pF	
			Gate to cathode	—	350	—		

Coupled Characteristics (Ta = 25°C)

Characteristic	Symbol	Test Condition	Min.	Typ.	Max.	Unit
Trigger LED current	I_{FT}	$V_{AK} = 6\text{V}, R_{GK} = 27\text{k}\Omega$	—	—	15	mA
Turn-on time	t_{on}	$I_F = 30\text{mA}, V_{AA} = 50\text{V}$ $R_{GK} = 27\text{k}\Omega$	—	10	—	μs
Coupled dv / dt	dv / dt	$V_S = 500\text{V}, R_{GK} = 27\text{k}\Omega$	500	—	—	V / μs
Capacitance (input to output)	C_S	$V_S = 0, f = 1\text{MHz}$	—	0.8	—	pF
Isolation resistance	R_S	$V_S = 500\text{V}, \text{R.H.} \leq 60\%$	1×10^{12}	10^{14}	—	Ω
Isolation voltage	BV_S	AC, 1 minute	4000	—	—	Vrms
		AC, 1 second, in oil	—	10000	—	
		DC, 1 minute, in oil	—	10000	—	Vdc

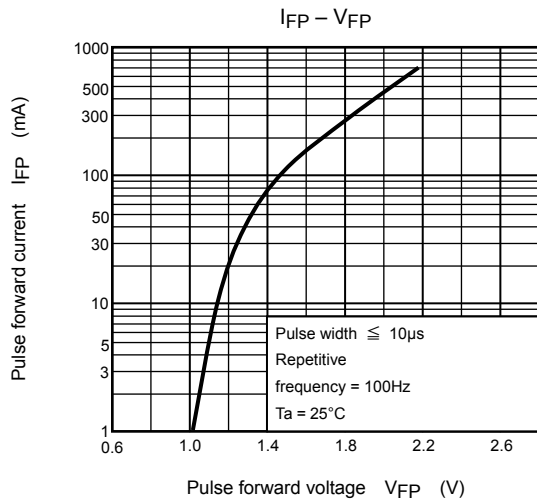
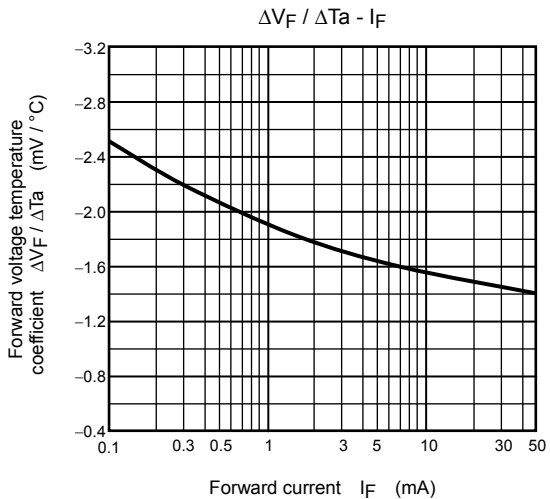
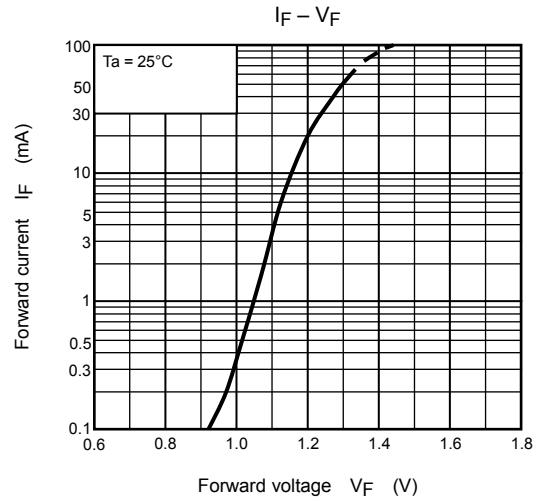
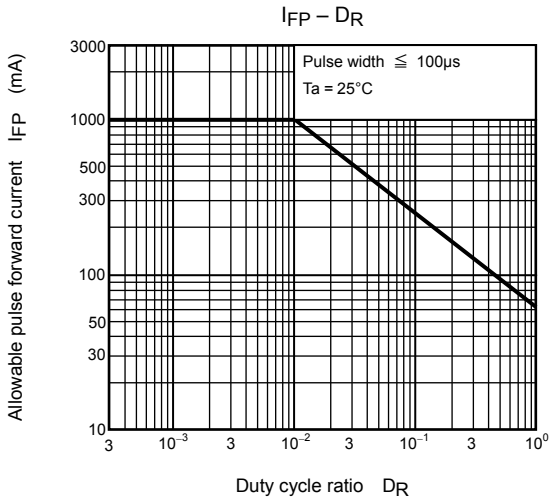
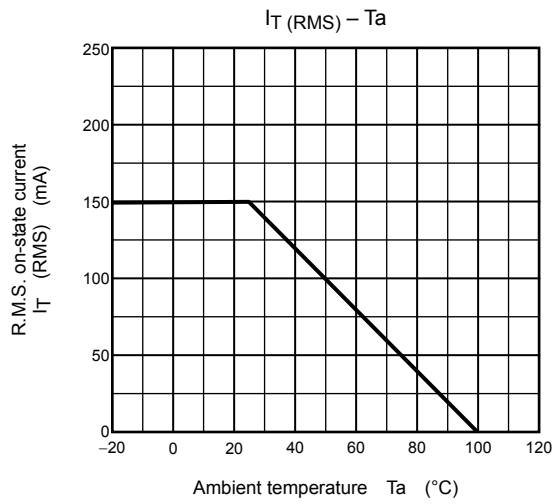
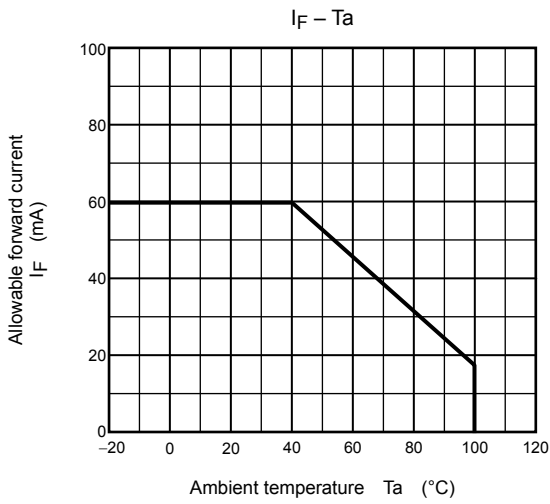

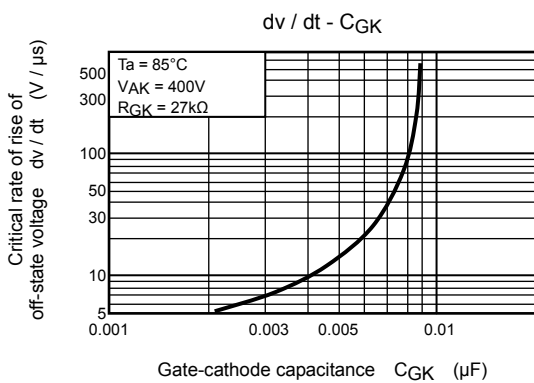
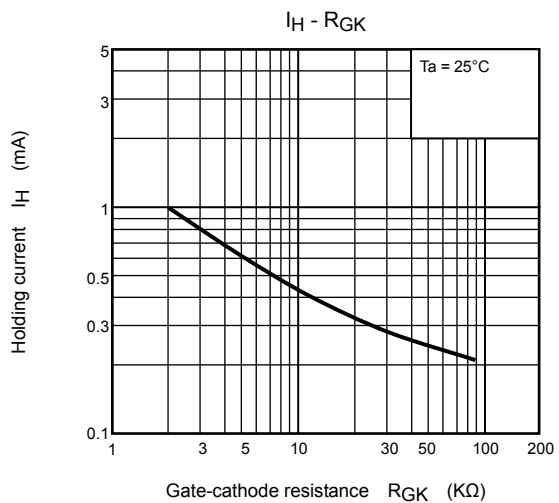
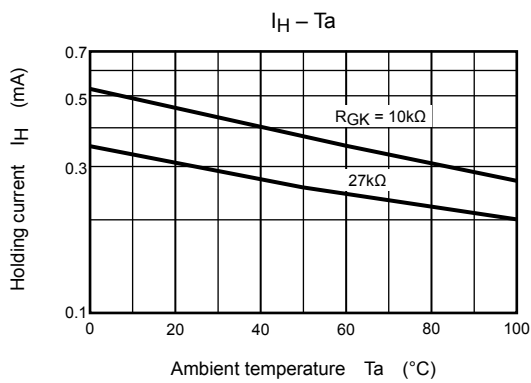
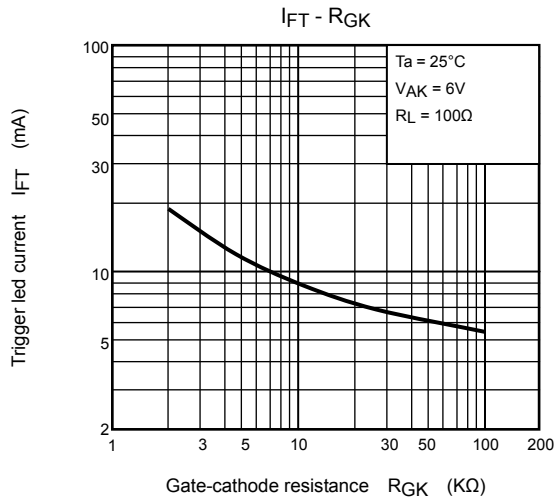
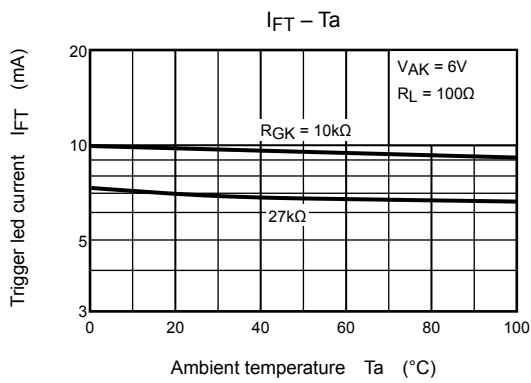
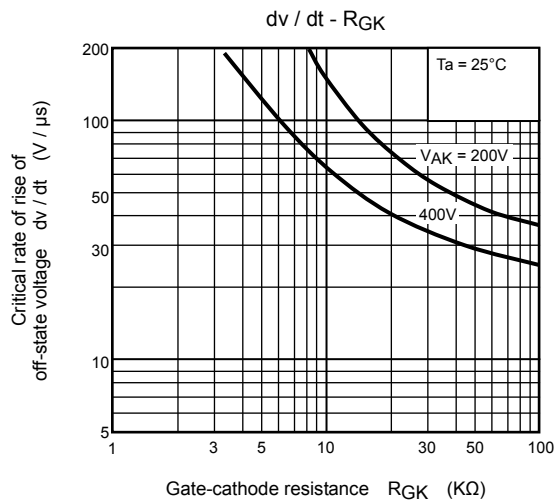
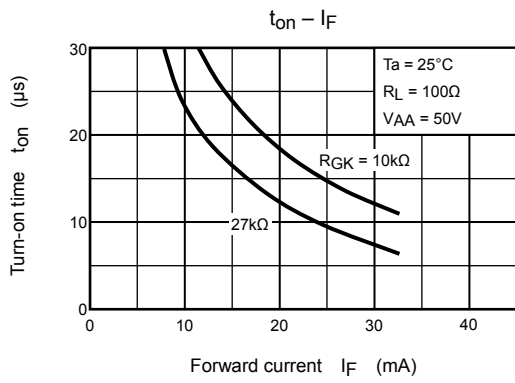

RESTRICTIONS ON PRODUCT USE

20070701-EN

- The information contained herein is subject to change without notice.
- TOSHIBA is continually working to improve the quality and reliability of its products. Nevertheless, semiconductor devices in general can malfunction or fail due to their inherent electrical sensitivity and vulnerability to physical stress. It is the responsibility of the buyer, when utilizing TOSHIBA products, to comply with the standards of safety in making a safe design for the entire system, and to avoid situations in which a malfunction or failure of such TOSHIBA products could cause loss of human life, bodily injury or damage to property.
In developing your designs, please ensure that TOSHIBA products are used within specified operating ranges as set forth in the most recent TOSHIBA products specifications. Also, please keep in mind the precautions and conditions set forth in the "Handling Guide for Semiconductor Devices," or "TOSHIBA Semiconductor Reliability Handbook" etc.
- The TOSHIBA products listed in this document are intended for usage in general electronics applications (computer, personal equipment, office equipment, measuring equipment, industrial robotics, domestic appliances, etc.). These TOSHIBA products are neither intended nor warranted for usage in equipment that requires extraordinarily high quality and/or reliability or a malfunction or failure of which may cause loss of human life or bodily injury ("Unintended Usage"). Unintended Usage include atomic energy control instruments, airplane or spaceship instruments, transportation instruments, traffic signal instruments, combustion control instruments, medical instruments, all types of safety devices, etc.. Unintended Usage of TOSHIBA products listed in this document shall be made at the customer's own risk.
- The products described in this document shall not be used or embedded to any downstream products of which manufacture, use and/or sale are prohibited under any applicable laws and regulations.
- The information contained herein is presented only as a guide for the applications of our products. No responsibility is assumed by TOSHIBA for any infringements of patents or other rights of the third parties which may result from its use. No license is granted by implication or otherwise under any patents or other rights of TOSHIBA or the third parties.
- GaAs(Gallium Arsenide) is used in this product. The dust or vapor is harmful to the human body. Do not break, cut, crush or dissolve chemically.
- Please contact your sales representative for product-by-product details in this document regarding RoHS compatibility. Please use these products in this document in compliance with all applicable laws and regulations that regulate the inclusion or use of controlled substances. Toshiba assumes no liability for damage or losses occurring as a result of noncompliance with applicable laws and regulations.