

ASDL-4670

High Performance T-1 (3mm) AlGaAs/GaAs Infrared (940nm) Lamp



Data Sheet

Description

ASDL-4670 is a high performance Infrared emitter that utilizes AlGaAs on GaAs LED technology. It is optimized for efficiency at emission wavelength of 940nm and is designed for application that requires high radiant intensity, low forward voltage at wide viewing angle. The emitter is encapsulated in clear T-1 (3mm) package.

Features

- T-1 Package
- 940nm wavelength
- Wide Viewing Angle
- Low Forward Voltage
- Lead Free and ROHS Compliant
- Available in Tape & Reel

Applications

- IR Remote Control for Consumer Device
- IR Remote Control for Industrial Equipment
- Portable Infrared Instruments
- Wireless Headset
- Infrared Illuminator Security Camera
- Photo-Interrupters
- Reflective Applications

Order Information

Part Number	Lead Form	Color	Packaging	Shipping Option
ASDL-4670-C22	Straight	Clear	Tape & Reel	4000pcs
ASDL-4670-C31			Bulk	8000pcs / Carton

Package Dimensions

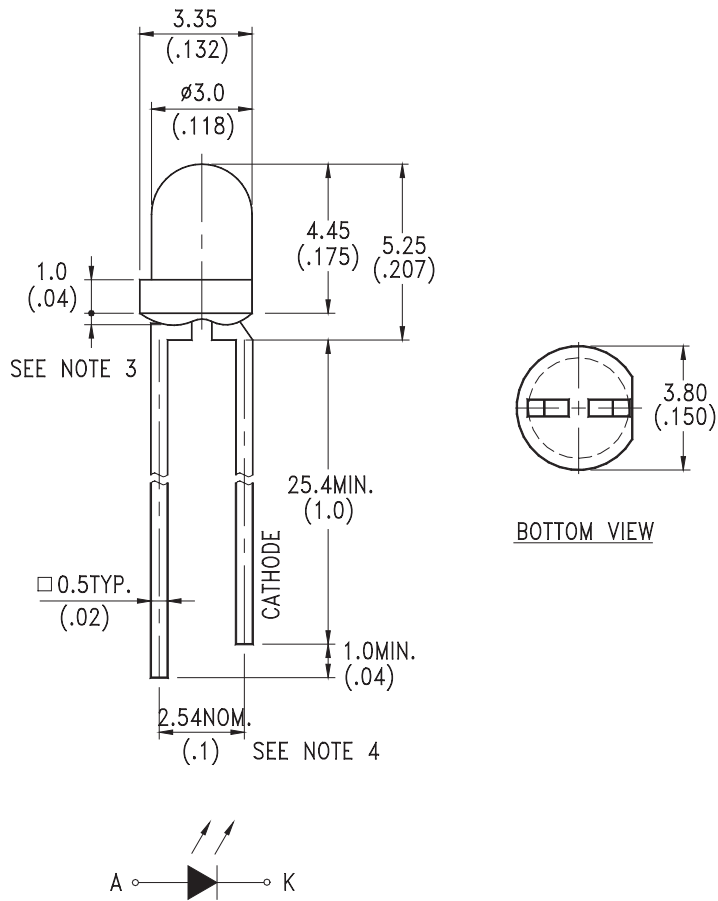

Notes:

1. All dimensions are in millimeters (inches)
2. Tolerance is + 0.25mm (.010") unless otherwise noted
3. Protruded resin under flange is 1.5mm (.059") max
4. Lead spacing is measured where leads emerge from package
5. Specifications are subject to change without notice for performance improvement

Absolute Maximum Ratings at 25°C

Parameter	Symbol	Min.	Max	Unit	Reference
Peak Forward Current	I_{FPK}		1	A	300pps
Continuous Forward Current	I_{FDC}		60	mA	
Power Dissipation	P_{DISS}		100	mW	
Reverse Voltage	V_R		5	V	
Operating Temperature	T_0	-40	85	°C	
Storage Temperature	T_S	-55	100	°C	
LED Junction Temperature	T_J		110	°C	
Lead Soldering Temperature			260°C for 5 sec		

Electrical Characteristics at 25°C

Parameter	Symbol	Min.	Typ.	Max.	Unit	Condition
Forward Voltage	V_F		1.2	1.6	V	$I_{FDC}=50mA$
Reverse Voltage	V_R	5			V	$I_R=100uA$
Thermal Resistance, Junction to Ambient	$R\theta_{ja}$		350		°C/W	

Optical Characteristics at 25°C

Parameter	Symbol	Min.	Typ.	Max.	Unit	Condition
Radiant On-Axis Intensity	I_E	2.71	-	7.67	mW/Sr	$I_{FDC}=20mA$
Viewing Angle	$2\theta_{1/2}$		60		deg	
Peak wavelength	λ_{PK}		940		nm	$I_{FDC} = 20mA$
Spectral Width	$\Delta\lambda$		50		nm	$I_{FDC} = 20mA$
Optical Rise Time	t_r		1		us	$I_{FPK}=100mA$ Duty Factor=50% Pulse Width=10us
Optical Fall Time	t_f		1		us	$I_{FPK}=100mA$ Duty Factor=50% Pulse Width=10us

Typical Electrical/Optical Characteristics Curves ($T_A=25^\circ\text{C}$ unless otherwise indicated)

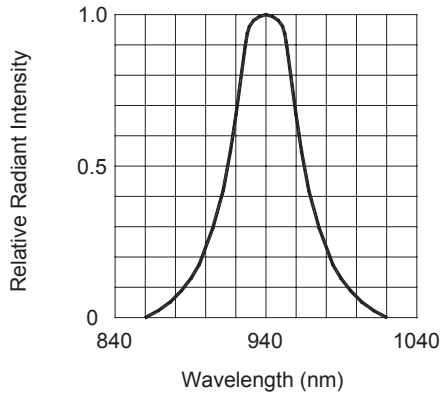

Figure 1. SPECTRAL DISTRIBUTION

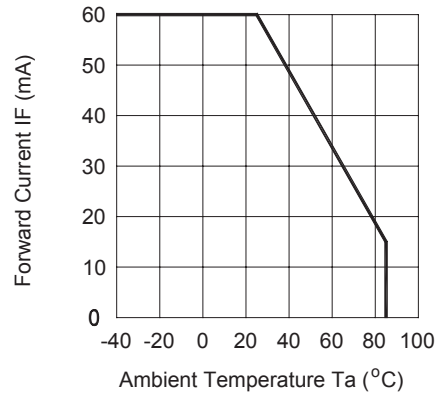

Figure 2. FORWARD CURRENT VS. AMBIENT TEMPERATURE

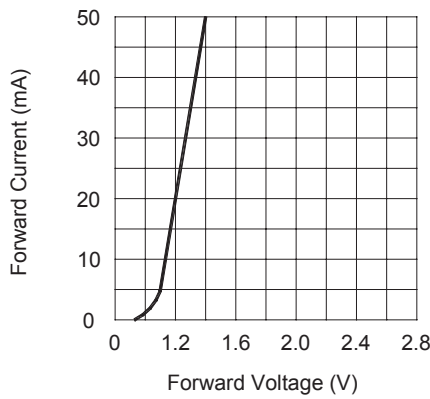

Figure 3. FORWARD CURRENT VS. FORWARD VOLTAGE

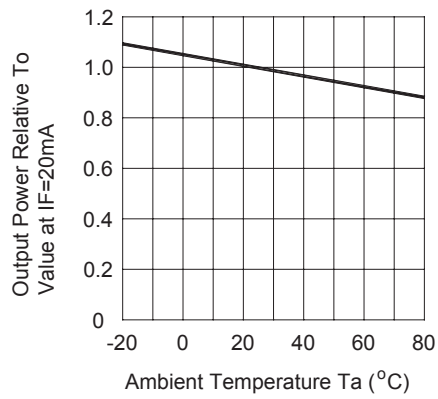

Figure 4. RELATIVE RADIANT INTENSITY VS. AMBIENT TEMPERATURE

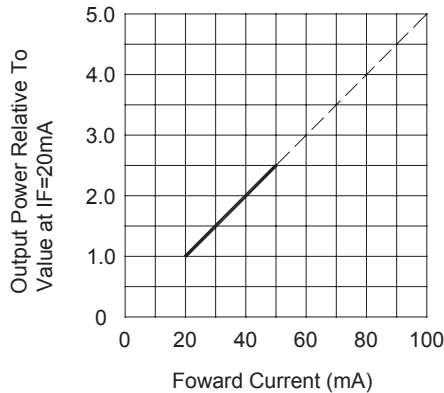

Figure 5. RELATIVE RADIANT INTENSITY VS. FORWARD CURRENT

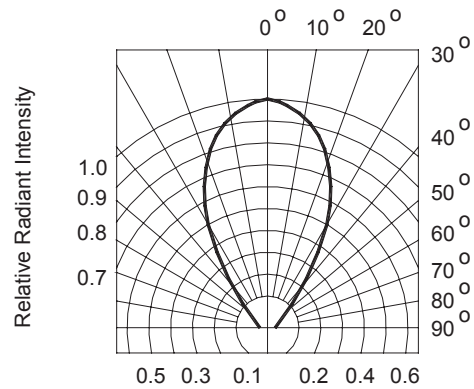

Figure 6. RADIATION DIAGRAM

For product information and a complete list of distributors, please go to our web site: www.avagotech.com

Avago, Avago Technologies, and the A logo are trademarks of Avago Technologies, Limited in the United States and other countries. Data subject to change. Copyright © 2007 Avago Technologies Limited. All rights reserved. AV02-0009EN - January 22, 2007

