

FDB12N50TM

N-Channel MOSFET

500V, 11.5A, 0.65Ω

Features

- $R_{DS(on)} = 0.55\Omega$ (Typ.) @ $V_{GS} = 10V, I_D = 6A$
- Low gate charge (Typ. 22nC)
- Low C_{rss} (Typ. 12pF)
- Fast switching
- 100% avalanche tested
- Improved dv/dt capability
- RoHS compliant



Description

These N-Channel enhancement mode power field effect transistors are produced using Fairchild's proprietary, planar stripe, DMOS technology.

This advanced technology has been especially tailored to minimize on-state resistance, provide superior switching performance, and withstand high energy pulse in the avalanche and commutation mode. These devices are well suited for high efficient switched mode power supplies and active power factor correction.

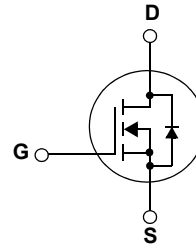
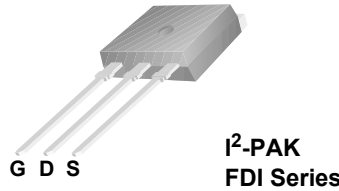
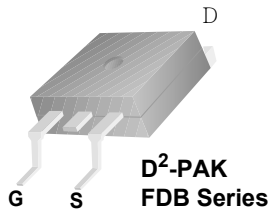

MOSFET Maximum Ratings $T_C = 25^\circ\text{C}$ unless otherwise noted

Symbol	Parameter	Ratings	Units
V_{DSS}	Drain to Source Voltage	500	V
V_{GSS}	Gate to Source Voltage	± 30	V
I_D	Drain Current	-Continuous ($T_C = 25^\circ\text{C}$)	11.5
		-Continuous ($T_C = 100^\circ\text{C}$)	6.9
I_{DM}	Drain Current	- Pulsed (Note 1)	46
E_{AS}	Single Pulsed Avalanche Energy	(Note 2)	456
I_{AR}	Avalanche Current	(Note 1)	11.5
E_{AR}	Repetitive Avalanche Energy	(Note 1)	16.7
dv/dt	Peak Diode Recovery dv/dt	(Note 3)	4.5
P_D	Power Dissipation	($T_C = 25^\circ\text{C}$)	165
		- Derate above 25°C	1.33
T_J, T_{STG}	Operating and Storage Temperature Range	-55 to +150	$^\circ\text{C}$
T_L	Maximum Lead Temperature for Soldering Purpose, 1/8" from Case for 5 Seconds	300	$^\circ\text{C}$

Thermal Characteristics

Symbol	Parameter	Ratings	Units
$R_{\theta JC}$	Thermal Resistance, Junction to Case	0.75	$^\circ\text{C}/\text{W}$
$R_{\theta JA}^*$	Thermal Resistance, Junction to Ambient*	40	
$R_{\theta JA}$	Thermal Resistance, Junction to Ambient	62.5	

*When mounted on the minimum pad size recommended (PCB Mount)

Package Marking and Ordering Information $T_C = 25^\circ\text{C}$ unless otherwise noted

Device Marking	Device	Package	Reel Size	Tape Width	Quantity
FDB12N50	FDB12N50TM	D ² -PAK	330mm	24mm	800
FDI12N50	FDI12N50TU	I ² -PAK	-	-	50

Electrical Characteristics

Symbol	Parameter	Test Conditions	Min.	Typ.	Max.	Units
--------	-----------	-----------------	------	------	------	-------

Off Characteristics

BV_{DSS}	Drain to Source Breakdown Voltage	$I_D = 250\mu\text{A}, V_{GS} = 0\text{V}, T_J = 25^\circ\text{C}$	500	-	-	V
$\frac{\Delta BV_{DSS}}{\Delta T_J}$	Breakdown Voltage Temperature Coefficient	$I_D = 250\mu\text{A}$, Referenced to 25°C	-	0.66	-	$V/^\circ\text{C}$
I_{DSS}	Zero Gate Voltage Drain Current	$V_{DS} = 500\text{V}, V_{GS} = 0\text{V}$ $V_{DS} = 400\text{V}, T_C = 125^\circ\text{C}$	-	-	1 10	μA
I_{GSS}	Gate to Body Leakage Current	$V_{GS} = \pm 30\text{V}, V_{DS} = 0\text{V}$	-	-	± 100	nA

On Characteristics

$V_{GS(th)}$	Gate Threshold Voltage	$V_{GS} = V_{DS}, I_D = 250\mu\text{A}$	3.0	-	5.0	V
$R_{DS(on)}$	Static Drain to Source On Resistance	$V_{GS} = 10\text{V}, I_D = 6\text{A}$	-	0.55	0.65	Ω
g_{FS}	Forward Transconductance	$V_{DS} = 25\text{V}, I_D = 6\text{A}$ (Note 4)	-	11	-	S

Dynamic Characteristics

C_{iss}	Input Capacitance	$V_{DS} = 25\text{V}, V_{GS} = 0\text{V}$ $f = 1\text{MHz}$	-	985	1315	pF
C_{oss}	Output Capacitance		-	140	190	pF
C_{rss}	Reverse Transfer Capacitance		-	12	17	pF
Q_g	Total Gate Charge at 10V	$V_{DS} = 400\text{V}, I_D = 11.5\text{A}$ $V_{GS} = 10\text{V}$	-	22	30	nC
Q_{gs}	Gate to Source Gate Charge		-	6	-	nC
Q_{gd}	Gate to Drain "Miller" Charge		-	10	-	nC

Switching Characteristics

$t_{d(on)}$	Turn-On Delay Time	$V_{DD} = 250\text{V}, I_D = 11.5\text{A}$ $R_G = 25\Omega$	-	25	60	ns
t_r	Turn-On Rise Time		-	60	130	ns
$t_{d(off)}$	Turn-Off Delay Time		-	45	105	ns
t_f	Turn-Off Fall Time		(Note 4, 5)	-	35	85

Drain-Source Diode Characteristics

I_S	Maximum Continuous Drain to Source Diode Forward Current	-	-	11.5	A	
I_{SM}	Maximum Pulsed Drain to Source Diode Forward Current	-	-	46	A	
V_{SD}	Drain to Source Diode Forward Voltage	$V_{GS} = 0\text{V}, I_{SD} = 11.5\text{A}$	-	-	1.4	V
t_{rr}	Reverse Recovery Time	$V_{GS} = 0\text{V}, I_{SD} = 11.5\text{A}$	-	370	-	ns
Q_{rr}	Reverse Recovery Charge	$di_F/dt = 100\text{A}/\mu\text{s}$ (Note 4)	-	3.8	-	μC

Notes:

1. Repetitive Rating: Pulse width limited by maximum junction temperature
2. $L = 6.9\text{mH}, I_{AS} = 11.5\text{A}, V_{DD} = 50\text{V}, R_G = 25\Omega$, Starting $T_J = 25^\circ\text{C}$
3. $I_{SD} \leq 11.5\text{A}, di/dt \leq 200\text{A}/\mu\text{s}, V_{DD} \leq BV_{DSS}$, Starting $T_J = 25^\circ\text{C}$
4. Pulse Test: Pulse width $\leq 300\mu\text{s}$, Duty Cycle $\leq 2\%$
5. Essentially Independent of Operating Temperature Typical Characteristics

Typical Performance Characteristics

Figure 1. On-Region Characteristics

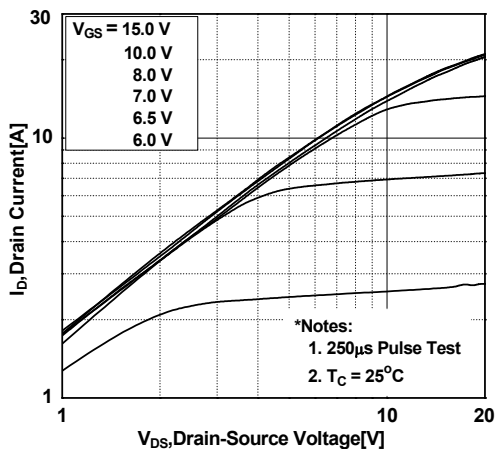

Figure 2. Transfer Characteristics

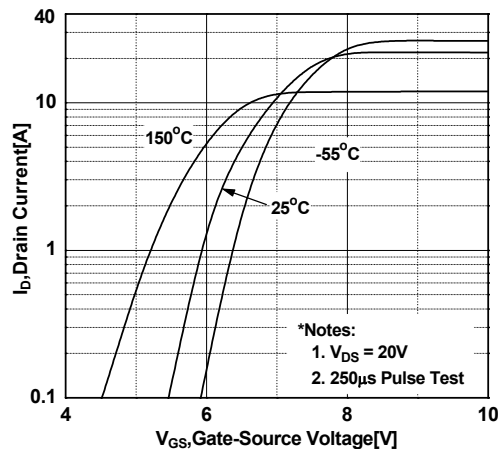

Figure 3. On-Resistance Variation vs. Drain Current and Gate Voltage

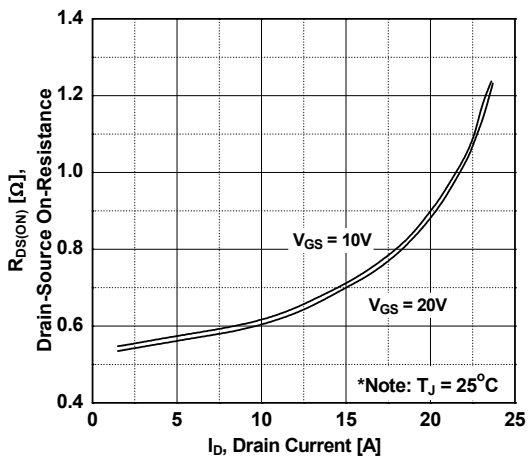

Figure 4. Body Diode Forward Voltage Variation vs. Source Current and Temperature

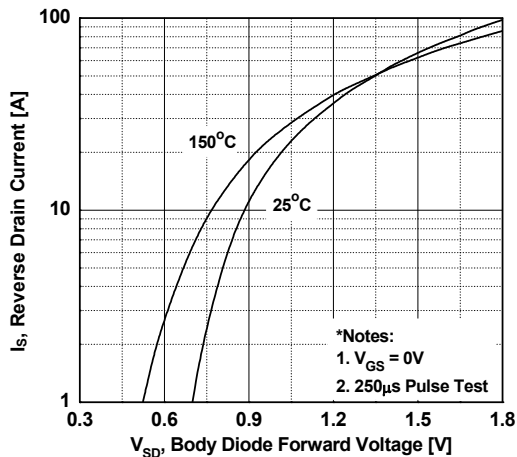

Figure 5. Capacitance Characteristics

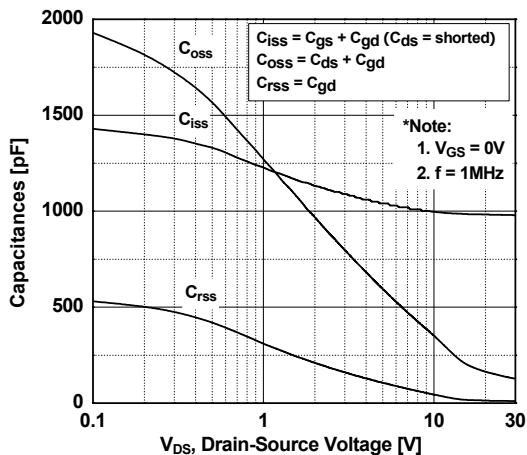
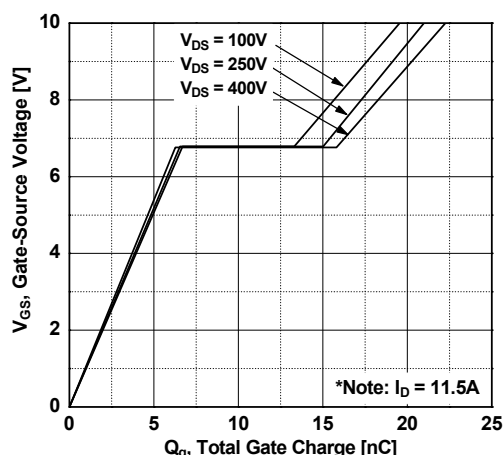

Figure 6. Gate Charge Characteristics



Typical Performance Characteristics (Continued)

Figure 7. Breakdown Voltage Variation vs. Temperature

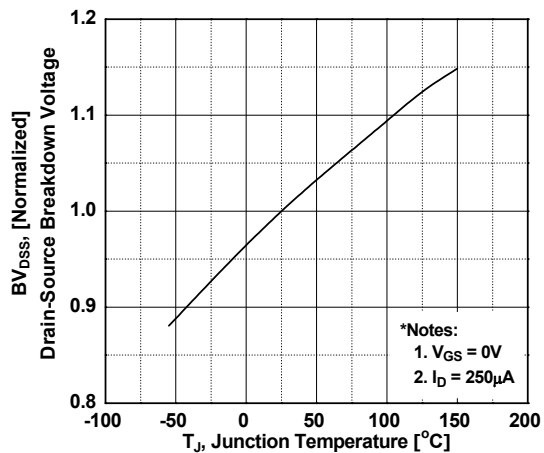

Figure 8. On-Resistance Variation vs. Temperature

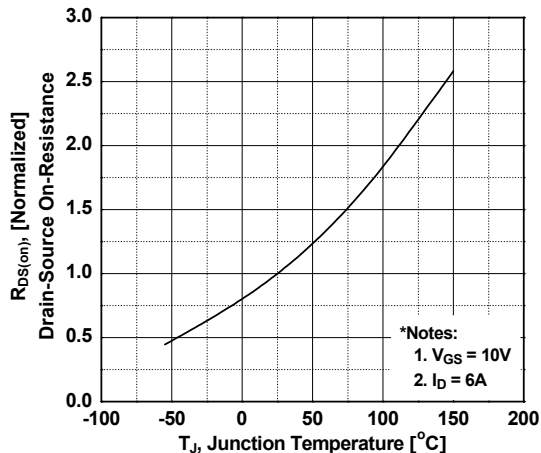

Figure 9. Maximum Safe Operating Area

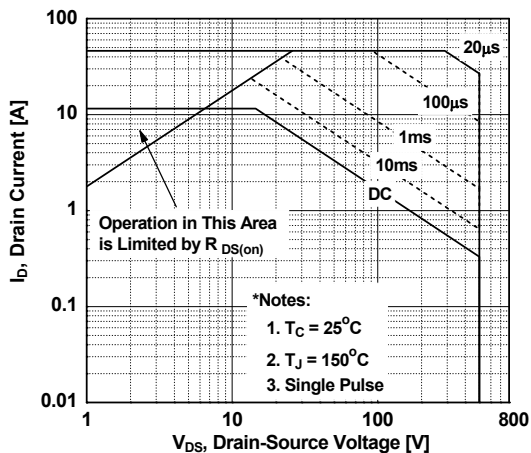

Figure 10. Maximum Drain Current vs. Case Temperature

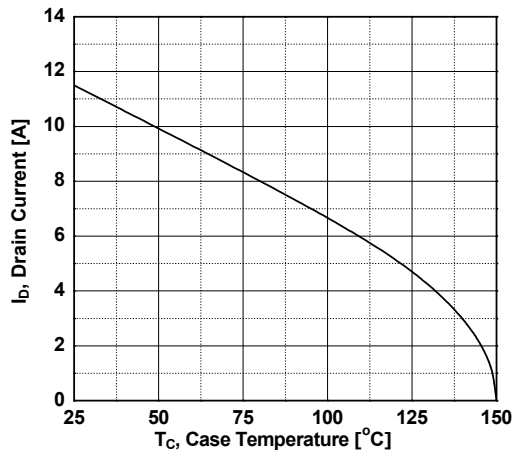
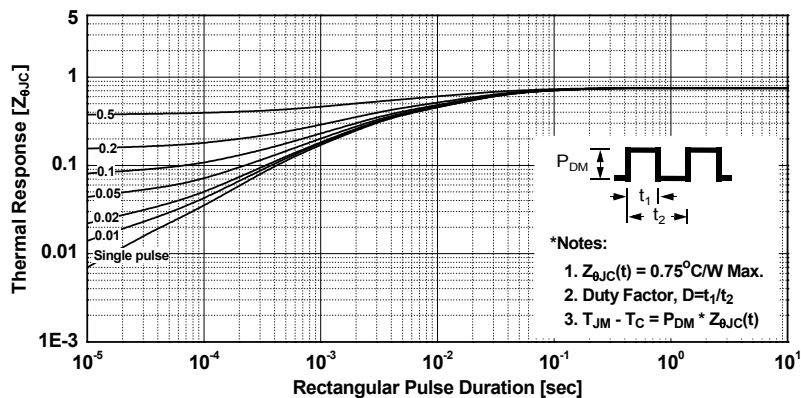
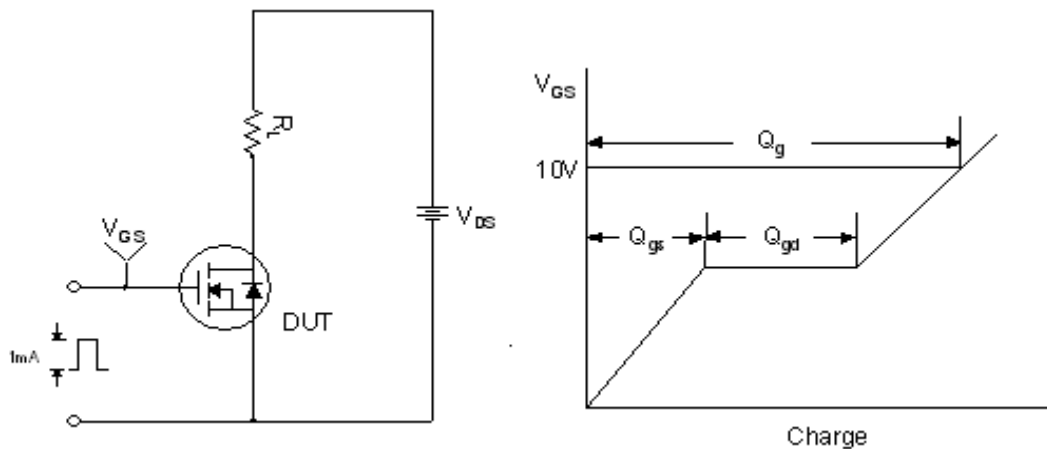

Figure 11. Transient Thermal Response Curve



Gate Charge Test Circuit & Waveform



Resistive Switching Test Circuit & Waveforms

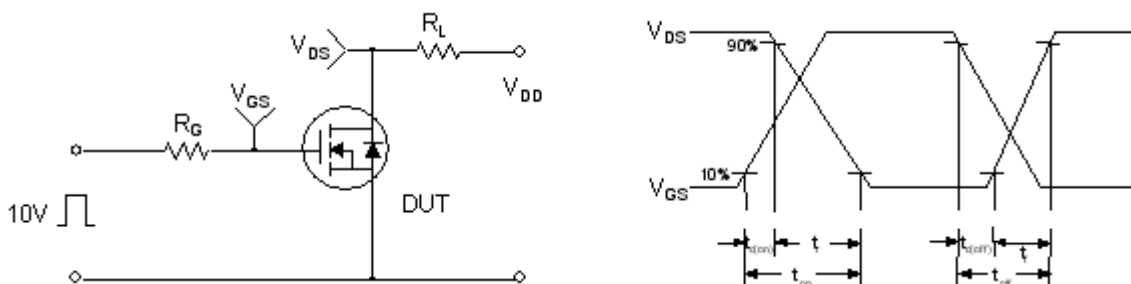

Unclamped Inductive Switching Test Circuit & Waveforms

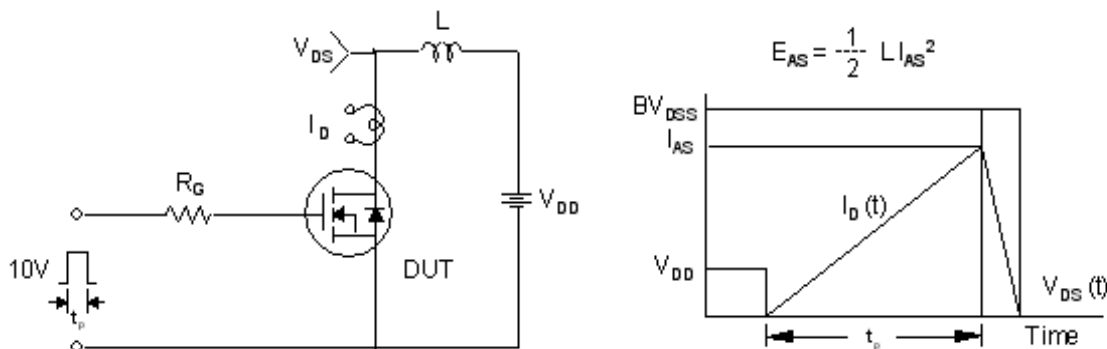

Peak Diode Recovery dv/dt Test Circuit & Waveforms

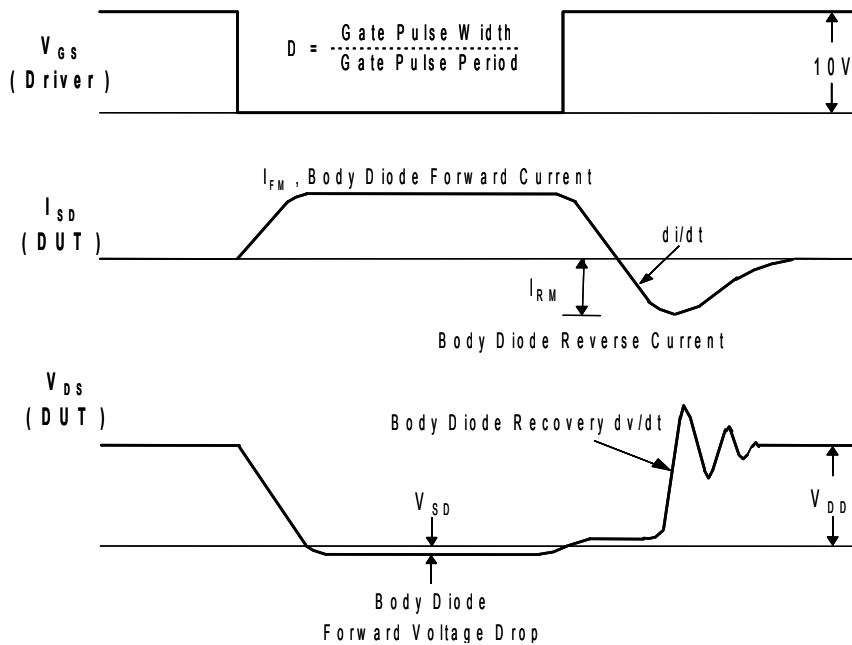
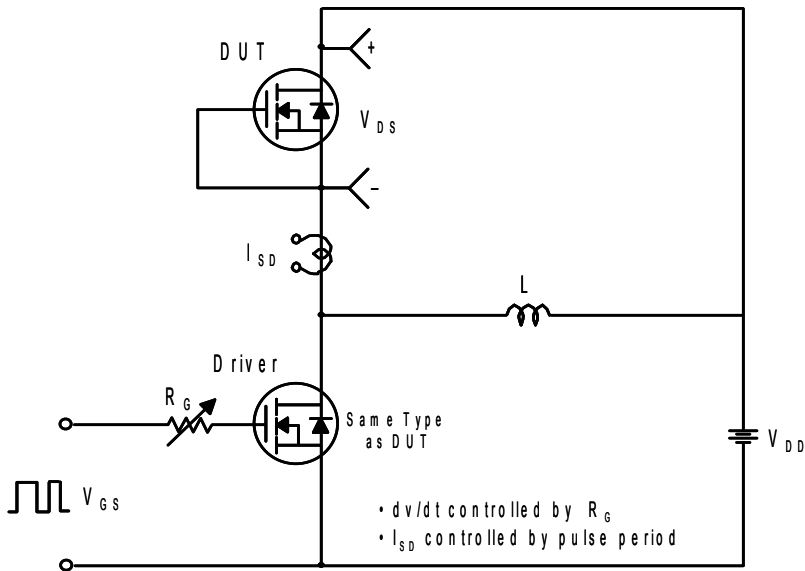

Mechanical Dimensions

D²-PAK

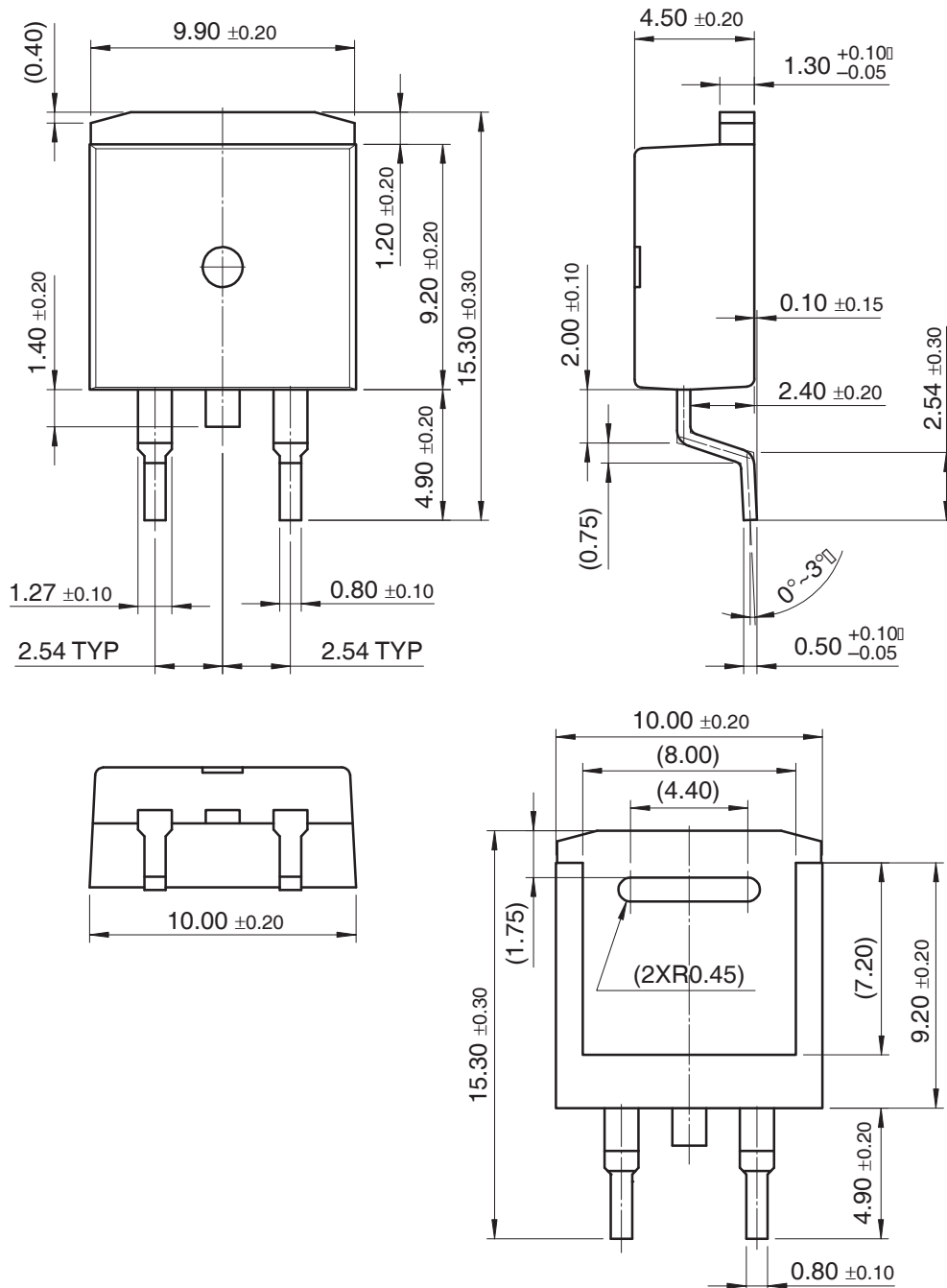

Mechanical Dimensions

I²-PAK

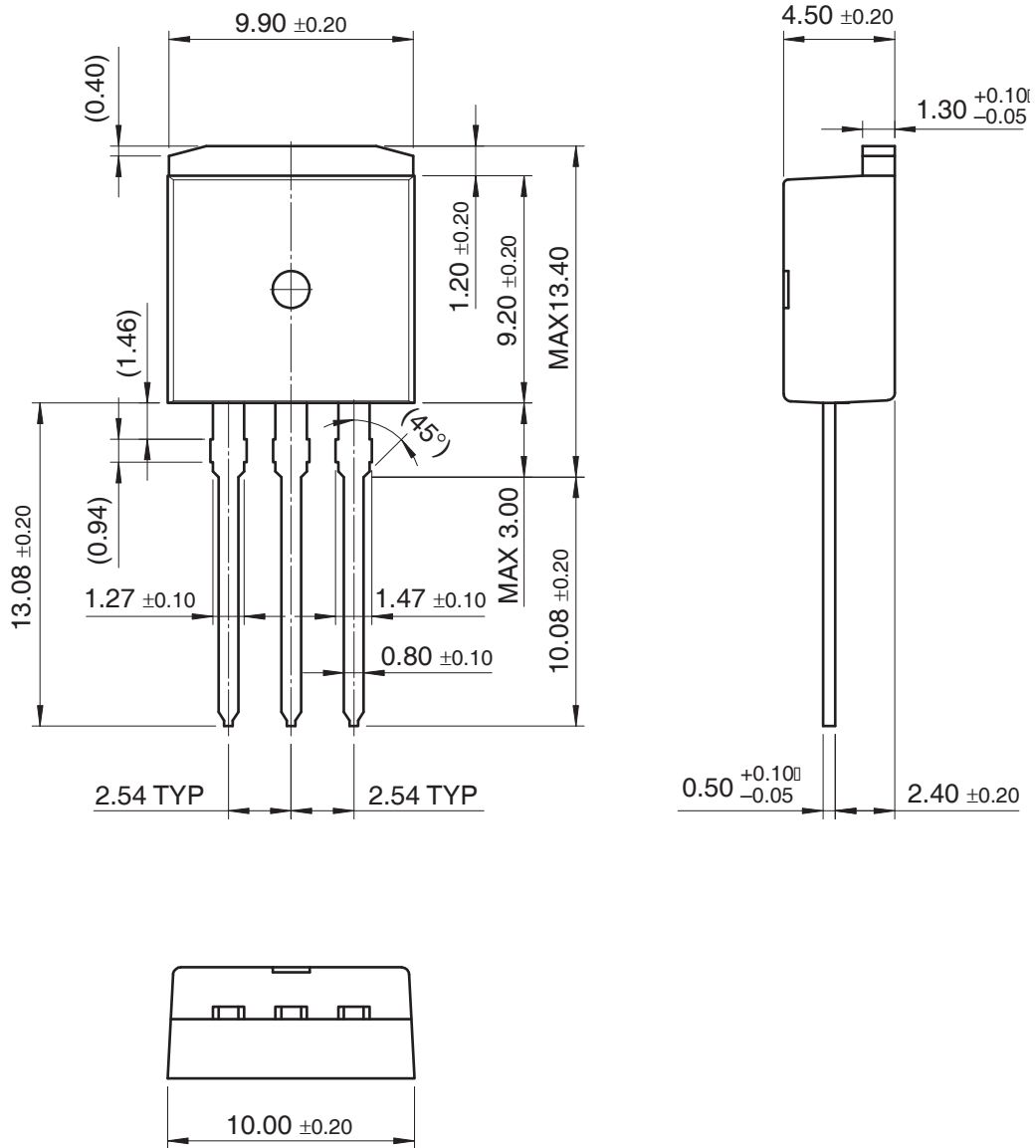

FDB12N50 / FDI12N50 N-Channel MOSFET



TRADEMARKS

The following are registered and unregistered trademarks Fairchild Semiconductor owns or is authorized to use and is not intended to be an exhaustive list of all such trademarks.

ACEx®	<i>i-Lo</i> ™	Power-SPM™	TinyBoost™
Across the board. Around the world.™	ImpliedDisconnect™	PowerTrench®	TinyBuck™
ActiveArray™	IntelliMAX™	Programmable Active Droop™	TinyLogic®
Bottomless™	ISOPLANAR™	QFET®	TINYOPTO™
Build it Now™	MICROCOUPLER™	QS™	TinyPower™
CoolFET™	MicroPak™	QT Optoelectronics™	TinyWire™
CROSSVOLT™	MICROWIRE™	Quiet Series™	TruTranslation™
CTL™	Motion-SPM™	RapidConfigure™	µSerDes™
Current Transfer Logic™	MSX™	RapidConnect™	UHC®
DOME™	MSXPro™	ScalarPump™	UniFET™
E ² CMOS™	OCX™	SMART START™	VCX™
EcoSPARK®	OCXPro™	SPM®	Wire™
EnSigna™	OPTOLOGIC®	STEALTH™	
FACT Quiet Series™	OPTOPLANAR®	SuperFET™	
FACT®	PACMAN™	SuperSOT™-3	
FAST®	PDP-SPM™	SuperSOT™-6	
FASTr™	POP™	SuperSOT™-8	
FPS™	Power220®	SyncFET™	
FRFET®	Power247®	TCM™	
GlobalOptoisolator™	PowerEdge™	The Power Franchise®	
GTO™	PowerSaver™		
HiSeC™			

DISCLAIMER

FAIRCHILD SEMICONDUCTOR RESERVES THE RIGHT TO MAKE CHANGES WITHOUT FURTHER NOTICE TO ANY PRODUCTS HEREIN TO IMPROVE RELIABILITY, FUNCTION OR DESIGN. FAIRCHILD DOES NOT ASSUME ANY LIABILITY ARISING OUT OF THE APPLICATION OR USE OF ANY PRODUCT OR CIRCUIT DESCRIBED HEREIN; NEITHER DOES IT CONVEY ANY LICENSE UNDER ITS PATENT RIGHTS, NOR THE RIGHTS OF OTHERS. THESE SPECIFICATIONS DO NOT EXPAND THE TERMS OF FAIRCHILD'S WORLDWIDE TERMS AND CONDITIONS, SPECIFICALLY THE WARRANTY THEREIN, WHICH COVERS THESE PRODUCTS.

LIFE SUPPORT POLICY

FAIRCHILD'S PRODUCTS ARE NOT AUTHORIZED FOR USE AS CRITICAL COMPONENTS IN LIFE SUPPORT DEVICES OR SYSTEMS WITHOUT THE EXPRESS WRITTEN APPROVAL OF FAIRCHILD SEMICONDUCTOR CORPORATION.

As used herein:

- Life support devices or systems are devices or systems which, (a) are intended for surgical implant into the body or (b) support or sustain life, and (c) whose failure to perform when properly used in accordance with instructions for use provided in the labeling, can be reasonably expected to result in a significant injury of the user.
- A critical component in any component of a life support, device, or system whose failure to perform can be reasonably expected to cause the failure of the life support device or system, or to affect its safety or effectiveness.

PRODUCT STATUS DEFINITIONS

Definition of Terms

Datasheet Identification	Product Status	Definition
Advance Information	Formative or In Design	This datasheet contains the design specifications for product development. Specifications may change in any manner without notice.
Preliminary	First Production	This datasheet contains preliminary data; supplementary data will be published at a later date. Fairchild Semiconductor reserves the right to make changes at any time without notice to improve design.
No Identification Needed	Full Production	This datasheet contains final specifications. Fairchild Semiconductor reserves the right to make changes at any time without notice to improve design.
Obsolete	Not In Production	This datasheet contains specifications on a product that has been discontinued by Fairchild Semiconductor. The datasheet is printed for reference information only.

Rev. I26