

**DATA SHEET**

# SKY12143-315: HIP3™ Variable Attenuator for AMPS and GSM Base Stations

**Features**

- 23 dB attenuation range
- 1.5 dB insertion loss, 1.5:1 SWR
- 0–12 V control voltage
- 43 dBm IP3
- Small footprint LGA package
- Designed for AMPS and GSM base stations
- Lead (Pb)-free and RoHS-compliant

**Description**

The SKY12143-315 is a voltage controlled, variable attenuator from Skyworks series of HIP3™ components. It is specifically designed and specified for use as a wide dynamic range, low-distortion attenuator for AMPS and GSM base station applications centered at 881.5 MHz and 942.5 MHz. The SKY12143-315 employs a monolithic quadrature hybrid and a pair of silicon PIN diodes to achieve the specified low-distortion performance. It operates from 0–12 V at 1.6 mA typical control current at maximum attenuation. The SKY12143-315 is packaged in a small outline LGA (Land Grid Array) surface mount package with the internal elements affixed to an organic BT substrate.

**Connection Diagram**

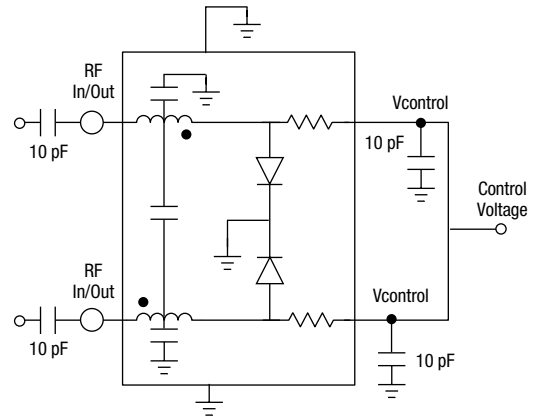

**NEW** Skyworks offers lead (Pb)-free, RoHS (Restriction of Hazardous Substances)-compliant packaging.



**Electrical Specifications at 25 °C**

**Z<sub>0</sub> = 50 Ω, unless otherwise noted**

Parameter	Condition	Min.	Typ.	Max.	Unit
AMPS frequency range (BW)		869		894	MHz
GSM frequency range (BW)		925		960	MHz
Control voltage (V <sub>CONTROL</sub> ) range		0		12	V
Insertion loss in BW	V <sub>CONTROL</sub> = 0 V			1.5	dB
Attenuation range	At F <sub>0</sub> , V <sub>CONTROL</sub> = 10 V	18		22	dB
	At F <sub>0</sub> , V <sub>CONTROL</sub> = 12 V	23		–	dB
VSWR in BW				1.5	
IP3	900/905 MHz, V <sub>CONTROL</sub> = 0 V	43			dBm
IM3	8 dBm			-70	dBc

## Typical Performance Data

T = 25 °C, Z<sub>0</sub> = 50 Ω, unless otherwise noted

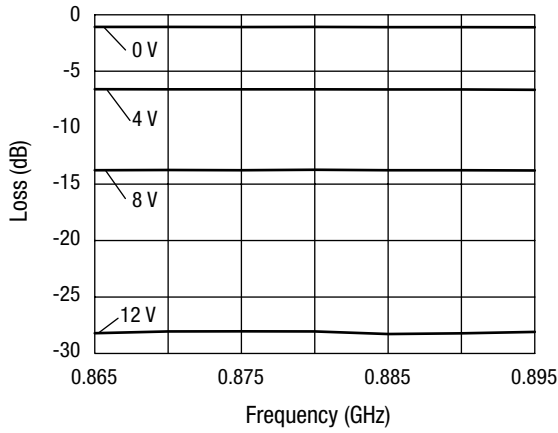

**Insertion Loss vs. Frequency and Control Voltage — AMPS Band**

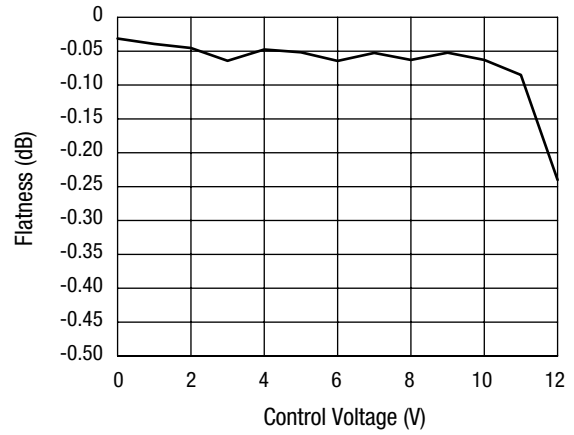

**Insertion Loss Flatness vs. Control Voltage — AMPS Band**

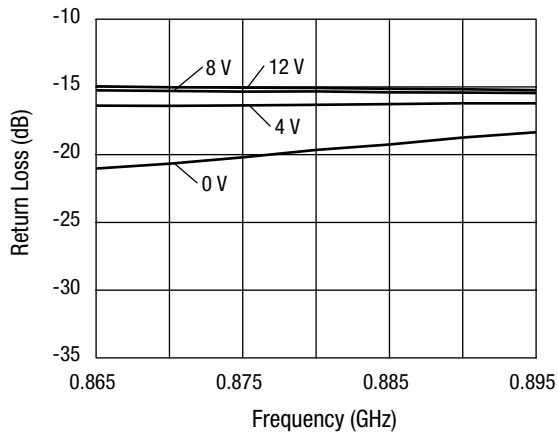

**Input/Output Return Loss vs. Frequency and Control Voltage — AMPS Band**

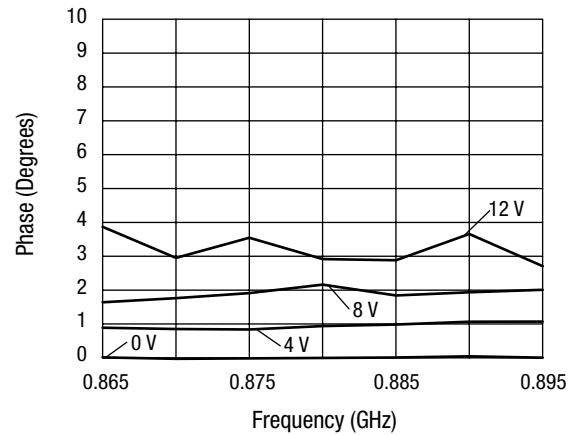

**Phase vs. Frequency and Control Voltage — AMPS Band**

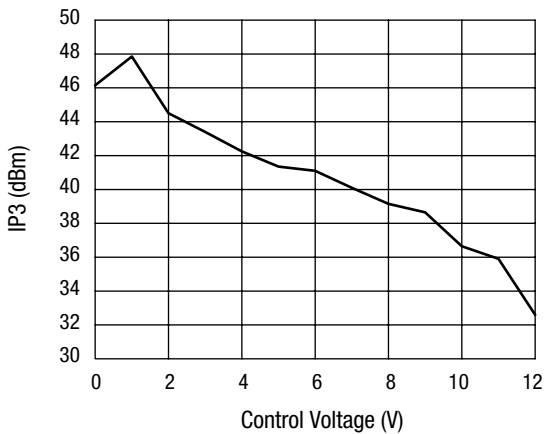

**3rd Order Intermod vs. Control Voltage**  
 RF<sub>1</sub> = 0.900 GHz, RF<sub>2</sub> = 0.905 GHz @ 8 dBm

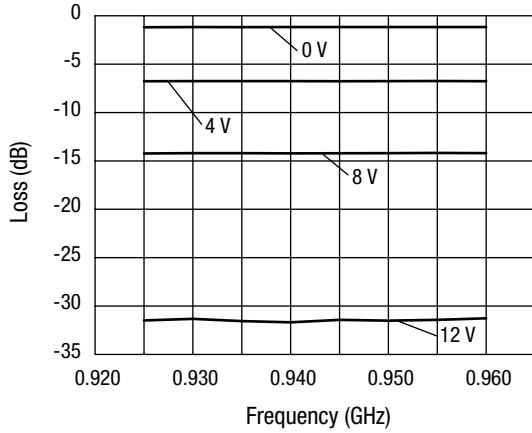

**Insertion Loss vs. Frequency and Control Voltage — GSM Band**

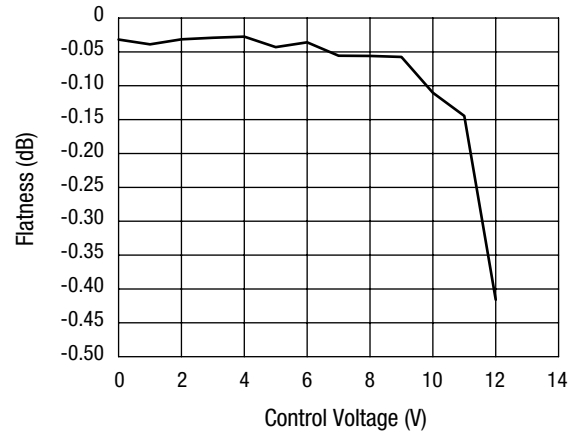

**Insertion Loss Flatness vs. Control Voltage — GSM Band**

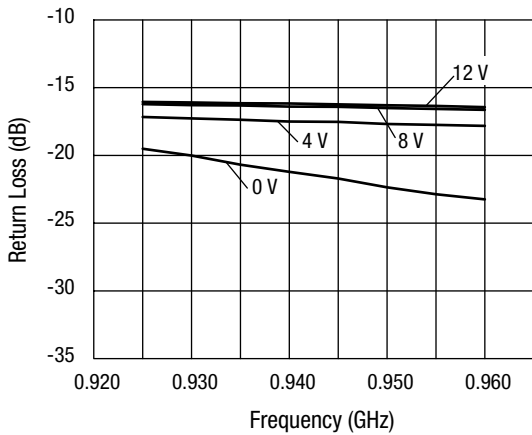

**Input/Output Return Loss vs. Frequency and Control Voltage — GSM Band**

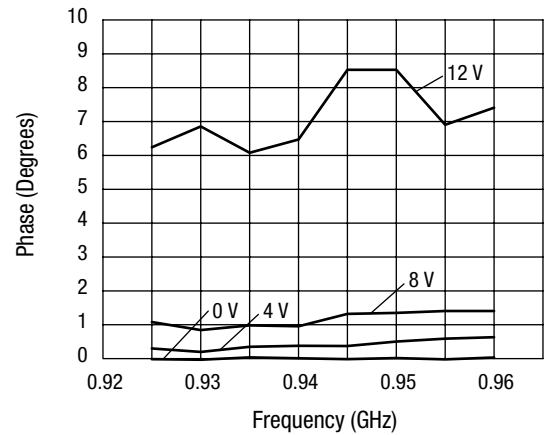

**Phase vs. Frequency and Control Voltage — GSM Band**

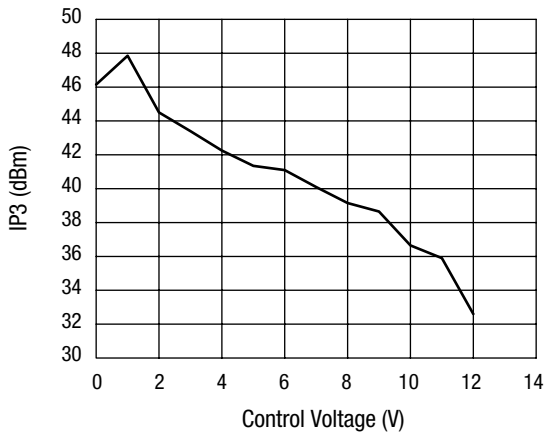

**3rd Order Intermod vs. Control Voltage**  
 $RF_1 = 0.900 \text{ GHz}$ ,  $RF_2 = 0.905 \text{ GHz}$  @ 8 dBm

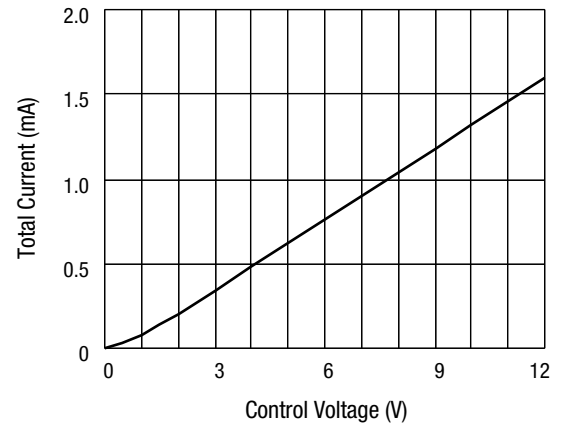

**Total Current vs. Control Voltage**

### Pin Out (Bottom View)

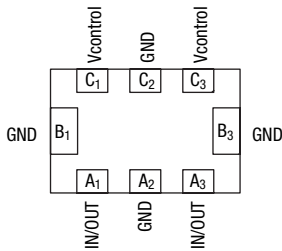

Terminal No.	Terminal Name
A <sub>1</sub> (Pin 1)	IN/OUT
A <sub>2</sub>	GND
A <sub>3</sub>	IN/OUT
B <sub>1</sub>	GND
B <sub>3</sub>	GND
C <sub>1</sub>	Vcontrol
C <sub>2</sub>	GND
C <sub>3</sub>	Vcontrol

### -315

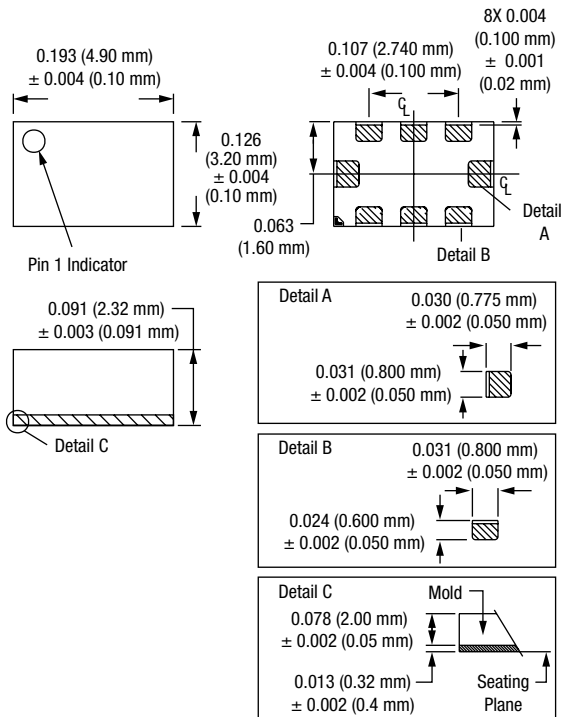

### Absolute Maximum Ratings

Characteristic	Value
RF input power	0.5 W CW, 4 W @ 12.5% duty cycle
Control voltage	15 V
Control current	50 mA each diode
Operating temperature	-40 °C to +85 °C
Storage temperature	-40 °C to +85 °C
Maximum reverse diode voltage	-10 V
Electrostatic discharge	Class 1A

Performance is guaranteed only under the conditions listed in the specifications table and is not guaranteed under the full range(s) described by the Absolute Maximum specifications. Exceeding any of the absolute maximum/minimum specifications may result in permanent damage to the device and will void the warranty.

**CAUTION:** Although this device is designed to be as robust as possible, ESD (Electrostatic Discharge) can damage this device. This device must be protected at all times from ESD. Static charges may easily produce potentials of several kilovolts on the human body or equipment, which can discharge without detection. Industry-standard ESD precautions must be employed at all times.

### Recommended Solder Reflow Profiles

Refer to the [“Recommended Solder Reflow Profile”](#) Application Note.

### Tape and Reel Information

Refer to the [“Discrete Devices and IC Switch/Attenuators Tape and Reel Package Orientation”](#) Application Note.

Copyright © 2002, 2003, 2004, 2005, Skyworks Solutions, Inc. All Rights Reserved.

Information in this document is provided in connection with Skyworks Solutions, Inc. ("Skyworks") products or services. These materials, including the information contained herein, are provided by Skyworks as a service to its customers and may be used for informational purposes only by the customer. Skyworks assumes no responsibility for errors or omissions in these materials or the information contained herein. Skyworks may change its documentation, products, services, specifications or product descriptions at any time, without notice. Skyworks makes no commitment to update the materials or information and shall have no responsibility whatsoever for conflicts, incompatibilities, or other difficulties arising from any future changes.

No license, whether express, implied, by estoppel or otherwise, is granted to any intellectual property rights by this document. Skyworks assumes no liability for any materials, products or information provided hereunder, including the sale, distribution, reproduction or use of Skyworks products, information or materials, except as may be provided in Skyworks Terms and Conditions of Sale.

THE MATERIALS, PRODUCTS AND INFORMATION ARE PROVIDED "AS IS" WITHOUT WARRANTY OF ANY KIND, WHETHER EXPRESS, IMPLIED, STATUTORY, OR OTHERWISE, INCLUDING FITNESS FOR A PARTICULAR PURPOSE OR USE, MERCHANTABILITY, PERFORMANCE, QUALITY OR NON-INFRINGEMENT OF ANY INTELLECTUAL PROPERTY RIGHT; ALL SUCH WARRANTIES ARE HEREBY EXPRESSLY DISCLAIMED. SKYWORKS DOES NOT WARRANT THE ACCURACY OR COMPLETENESS OF THE INFORMATION, TEXT, GRAPHICS OR OTHER ITEMS CONTAINED WITHIN THESE MATERIALS. SKYWORKS SHALL NOT BE LIABLE FOR ANY DAMAGES, INCLUDING BUT NOT LIMITED TO ANY SPECIAL, INDIRECT, INCIDENTAL, STATUTORY, OR CONSEQUENTIAL DAMAGES, INCLUDING WITHOUT LIMITATION, LOST REVENUES OR LOST PROFITS THAT MAY RESULT FROM THE USE OF THE MATERIALS OR INFORMATION, WHETHER OR NOT THE RECIPIENT OF MATERIALS HAS BEEN ADVISED OF THE POSSIBILITY OF SUCH DAMAGE.

Skyworks products are not intended for use in medical, lifesaving or life-sustaining applications, or other equipment in which the failure of the Skyworks products could lead to personal injury, death, physical or environmental damage. Skyworks customers using or selling Skyworks products for use in such applications do so at their own risk and agree to fully indemnify Skyworks for any damages resulting from such improper use or sale.

Customers are responsible for their products and applications using Skyworks products, which may deviate from published specifications as a result of design defects, errors, or operation of products outside of published parameters or design specifications. Customers should include design and operating safeguards to minimize these and other risks. Skyworks assumes no liability for applications assistance, customer product design, or damage to any equipment resulting from the use of Skyworks products outside of stated published specifications or parameters.

Skyworks, the Skyworks symbol, "Breakthrough Simplicity" and HIP3 are trademarks or registered trademarks of Skyworks Solutions, Inc., in the United States and other countries. Third-party brands and names are for identification purposes only, and are the property of their respective owners. Additional information, including relevant terms and conditions, posted at [www.skyworksinc.com](http://www.skyworksinc.com), are incorporated by reference.