



Power Bridge Rectifiers

SKB 30

Features

- Isolated metal case with screw terminals
- Blocking voltage up to 1600 V
- High surge current
- Easy chassis mounting
- UL recognized, file no. E 63 532

Typical Applications

- Single phase rectifiers for power supplies
- Input rectifiers for variable frequency drives
- Rectifiers for DC motor field supplies
- Battery charger rectifiers
- Recommended snubber network:
RC: 0.1 μ F, 50 Ω ($P_R = 1$ W)

- 1) Freely suspended or mounted on an insulator
- 2) Mounted on a painted metal sheet of min. 250 x 250 x 1 mm

V_{RSM}, V_{RRM} V	V_{VRMS} V	$I_D = 30$ A ($T_c = 94$ °C) Types	C_{max} μ F	R_{min} Ω
200		SKB 30/02A1		0,15
400		SKB 30/04A1		0,3
800		SKB 30/08A1		0,5
1200		SKB 30/12A1		0,75
1400		SKB 30/14A1		0,9
1600		SKB 30/16A1		1

Symbol	Conditions	Values	Units
I_D	$T_a = 45$ °C, isolated ¹⁾	6,5	A
	$T_a = 45$ °C, chassis ²⁾	15	A
I_{DCL}	$T_a = 45$ °C, isolated ¹⁾	6	A
	$T_a = 45$ °C, chassis ²⁾	13	A
	$T_a =$ °C,		A
I_{FSM}	$T_{vj} = 25$ °C, 10 ms	370	A
	$T_{vj} = 150$ °C, 10 ms	320	A
i^2t	$T_{vj} = 25$ °C, 8,3 ... 10 ms	680	A ² s
	$T_{vj} = 150$ °C, 8,3 ... 10 ms	500	A ² s
V_F	$T_{vj} = 25$ °C, $I_F = 150$ A	max. 2,2	V
$V_{(TO)}$	$T_{vj} = 150$ °C	max. 0,85	V
r_T	$T_{vj} = 150$ °C	max. 12	m Ω
I_{RD}	$T_{vj} = 25$ °C, $V_{RD} = V_{RRM}$	300	μ A
	$T_{vj} =$ °C, $V_{RD} = V_{RRM} \geq V$		μ A
I_{RD}	$T_{vj} = 150$ °C, $V_{RD} = V_{RRM}$	5	mA
	$T_{vj} =$ °C, $V_{RD} = V_{RRM} \geq V$		mA
t_{tr}	$T_{vj} = 25$ °C	25	μ s
f_G		2000	Hz
$R_{th(j-a)}$	isolated ¹⁾	8,5	K/W
	chassis ²⁾	3,3	K/W
$R_{th(j-c)}$	total	0,7	K/W
$R_{th(c-s)}$	total	0,1	K/W
T_{vj}		- 40 ... + 150	°C
T_{stg}		- 55 ... + 150	°C
V_{isol}	a. c. 50 ... 60 Hz; r.m.s.; 1 s / 1 min.	3000 / 2500	V~
M_s	to heatsink	5 \pm 15 %	Nm
M_t	to terminals	1,5 \pm 15 %	Nm
a			m/s ²
w		125	g
F_u		25	A
Case		G 12	

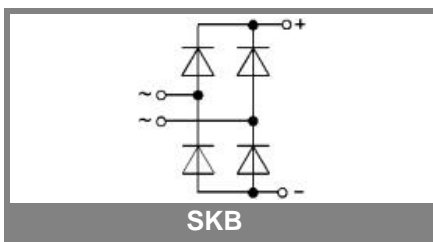

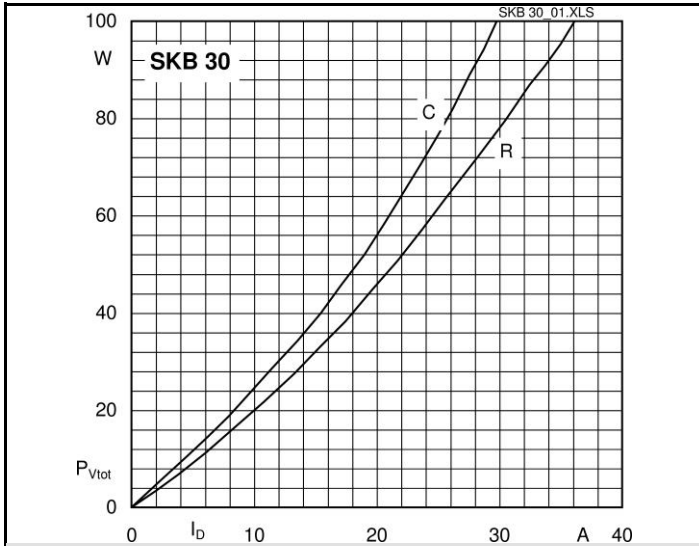

Fig. 3L Power dissipation vs. output current

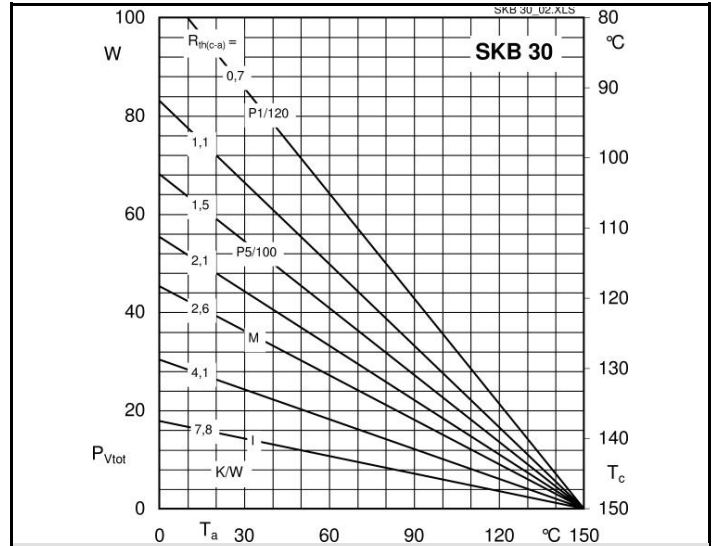

Fig. 3R Power dissipation vs. case temperature

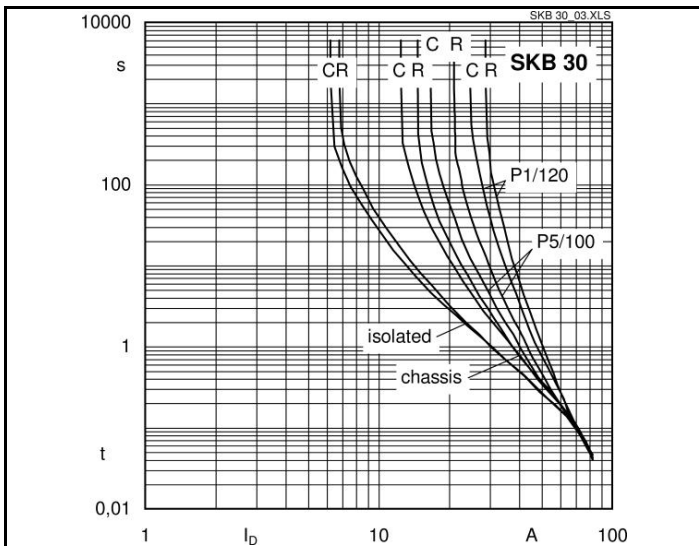

Fig. 6 Rated overload characteristics vs. time

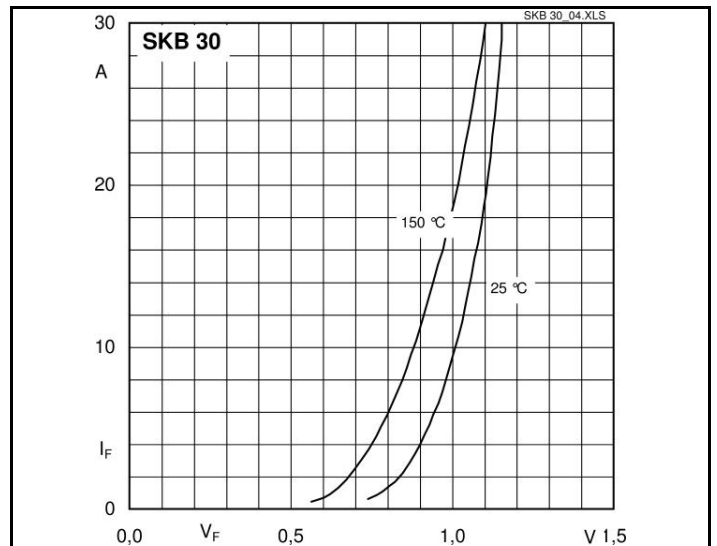
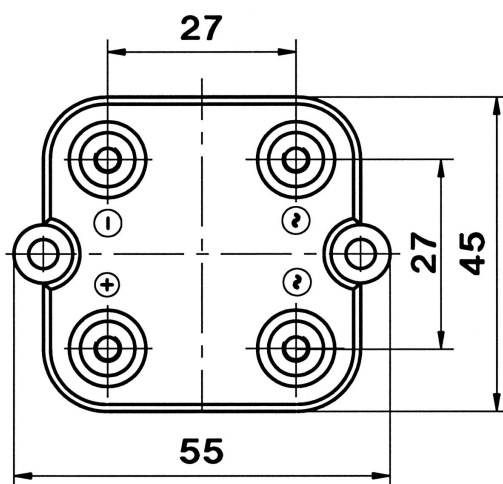
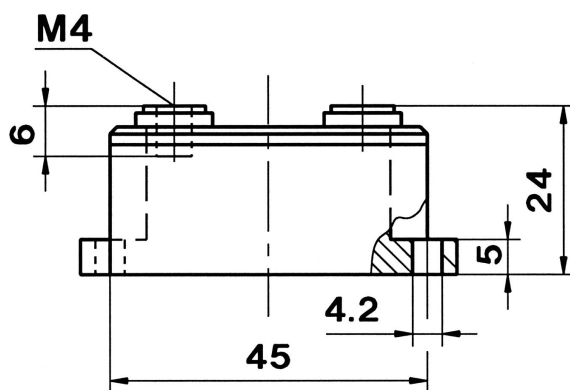

Fig. 9 Forward characteristics of a diode arm



Case G 12

This technical information specifies semiconductor devices but promises no characteristics. No warranty or guarantee expressed or implied is made regarding delivery, performance or suitability.