

288Mbits Network FCRAM2
 – 4,194,304-WORDS × 4 BANKS × 18-BITS

Lead-Free

DESCRIPTION

Network FCRAM™ is Double Data Rate Fast Cycle Random Access Memory. TC59LM818DMG is Network FCRAM™ containing 301,989,888 memory cells. TC59LM818DMG is organized as 4,194,304-words × 4 banks × 18 bits. TC59LM818DMG feature a fully synchronous operation referenced to clock edge whereby all operations are synchronized at a clock input which enables high performance and simple user interface coexistence. TC59LM818DMG can operate fast core cycle compared with regular DDR SDRAM.

TC59LM818DMG is suitable for Network, Server and other applications where large memory density and low power consumption are required. The Output Driver for Network FCRAM™ is capable of high quality fast data transfer under light loading condition.

FEATURES

PARAMETER		TC59LM818DMG	
		-33	-40
t _{CK} Clock Cycle Time (min)	CL = 4	4.5 ns	5.0 ns
	CL = 5	3.75 ns	4.5 ns
	CL = 6	3.33 ns	4.0 ns
t _{RC} Random Read/Write Cycle Time (min)		22.5 ns	25 ns
t _{RAC} Random Access Time (max)		22.5 ns	25 ns
I _{DD1S} Operating Current (single bank) (max)		235 mA	210 mA
I _{DD2P} Power Down Current (max)		65 mA	60 mA
I _{DD6} Self-Refresh Current (max)		15 mA	15 mA

- Fully Synchronous Operation
 - Double Data Rate (DDR)
Data input/output are synchronized with both edges of DS / QS.
 - Differential Clock (CLK and $\overline{\text{CLK}}$) inputs
CS, FN and all address input signals are sampled on the positive edge of CLK.
Output data (DQs and QS) is aligned to the crossings of CLK and $\overline{\text{CLK}}$.
- Fast clock cycle time of 3.33 ns minimum
Clock: 300 MHz maximum
Data: 600 Mbps/pin maximum
- Quad Independent Banks operation
- Fast cycle and Short Latency
- Selectable Data Strobe
- Distributed Auto-Refresh cycle in 3.9 μs
- Self-Refresh
- Power Down Mode
- Variable Write Length Control
- Write Latency = CAS Latency-1
- Programable CAS Latency and Burst Length
CAS Latency = 4, 5, 6
Burst Length = 2, 4
- Organization: 4,194,304 words × 4 banks × 18 bits
- Power Supply Voltage V_{DD}: 2.5 V ± 0.125V
V_{DDQ}: 1.4 V ~ 1.9 V
- Low voltage CMOS I/O covered with SSTL_18 (Half strength driver) and HSTL
- Package: 60Ball BGA, 1mm × 1mm Ball pitch (P-BGA60-0917-1.00AZ)
- Lead-Free

Notice: FCRAM is trademark of Fujitsu limited, Japan.

PIN NAMES

PIN	NAME
A0~A14	Address Input
BA0, BA1	Bank Address
DQ0~DQ17	Data Input/Output
\overline{CS}	Chip Select
FN	Function Control
\overline{PD}	Power Down Control
CLK, \overline{CLK}	Clock Input
DS / QS	Write/Read Data Strobe
V _{DD}	Power (+2.5 V)
V _{SS}	Ground
V _{DDQ}	Power (+1.5 V, +1.8 V) (for DQ buffer)
V _{SSQ}	Ground (for DQ buffer)
V _{REF}	Reference Voltage
NC	Not Connected

PIN ASSIGNMENT (TOP VIEW)

ball pitch=1.0 x 1.0mm

x18

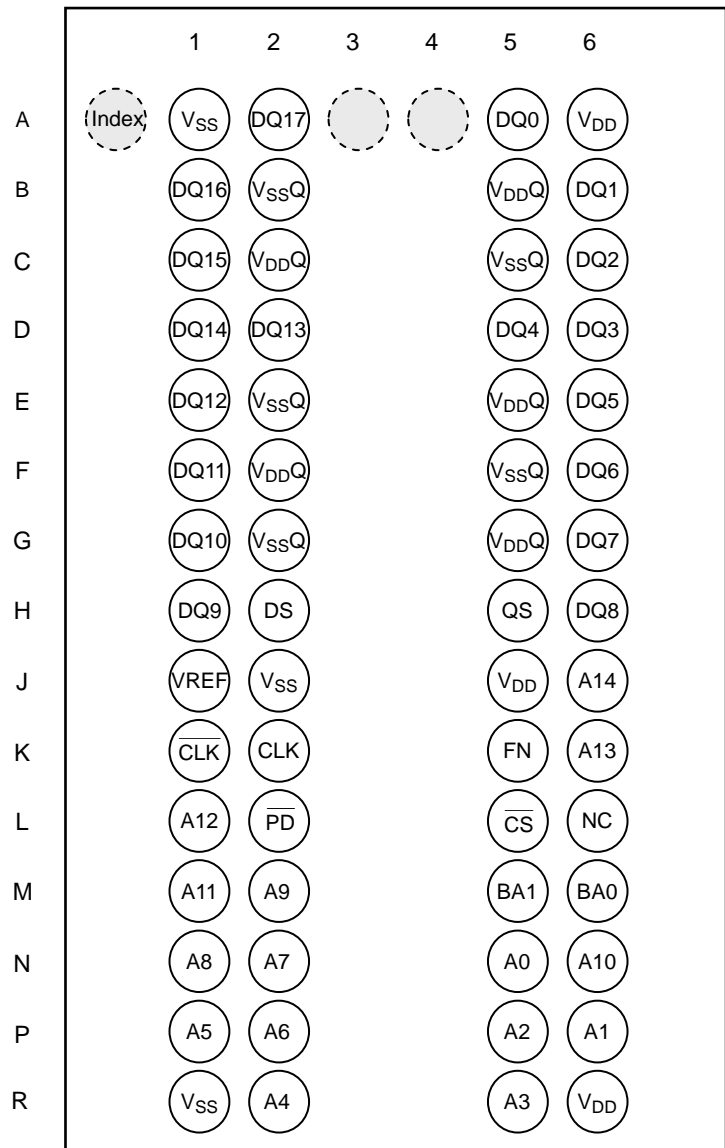

BLOCK DIAGRAM

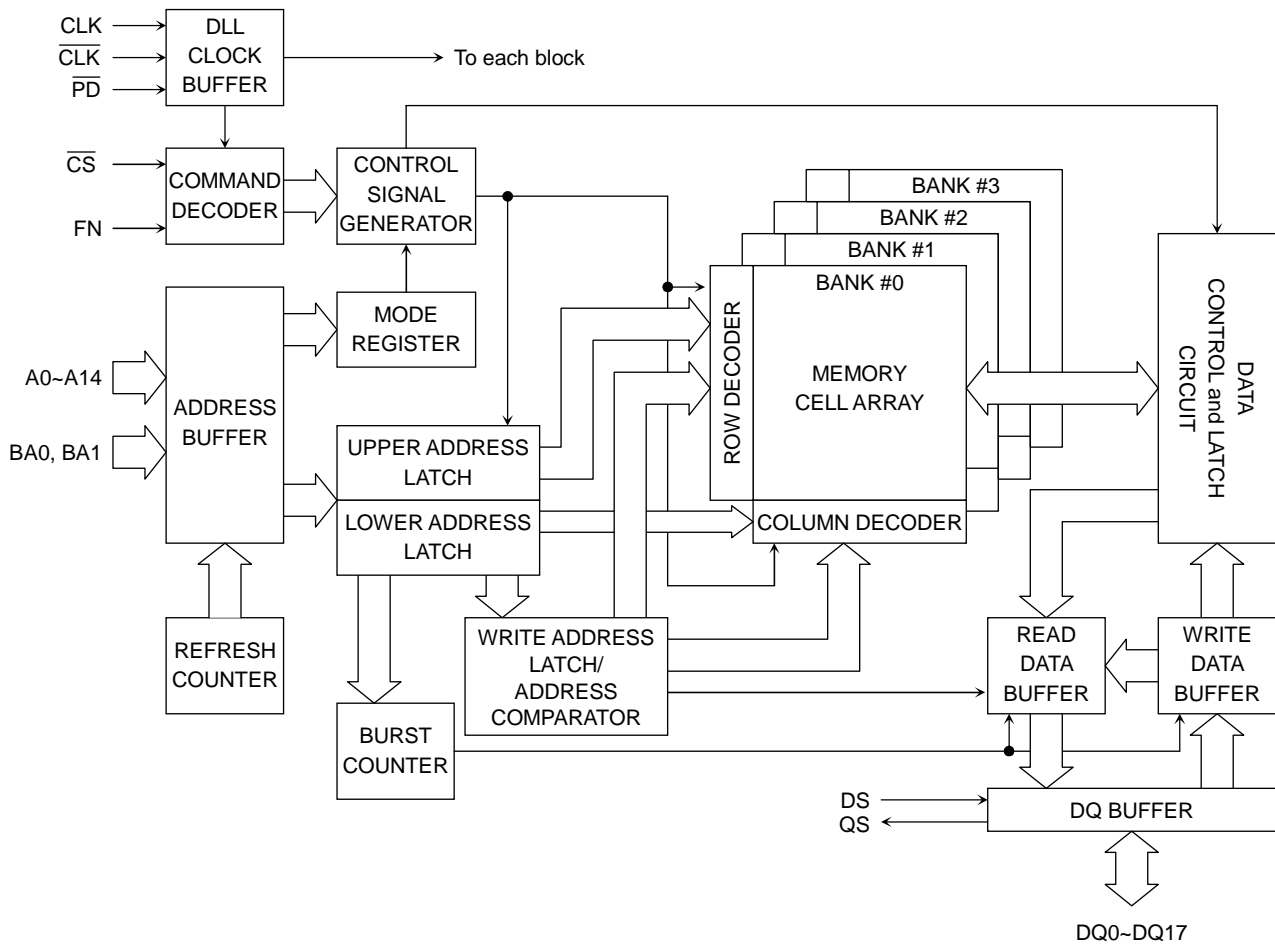

Note: The TC59LM818DMG configuration is 4 Bank of $32768 \times 128 \times 18$ of cell array with the DQ pins numbered DQ0-DQ17.

ABSOLUTE MAXIMUM RATINGS

SYMBOL	PARAMETER	RATING	UNIT	NOTES
V _{DD}	Power Supply Voltage	-0.3~ 3.3	V	
V _{DDQ}	Power Supply Voltage (for DQ buffer)	-0.3~V _{DD} + 0.3	V	
V _{IN}	Input Voltage	-0.3~V _{DD} + 0.3	V	
V _{OUT}	Output and DQ pin Voltage	-0.3~V _{DDQ} + 0.3	V	
V _{REF}	Input Reference Voltage	-0.3~V _{DD} + 0.3	V	
T _{opr}	Operating Temperature (case)	0~85	°C	
T _{stg}	Storage Temperature	-55~150	°C	
T _{solder}	Soldering Temperature (10 s)	260	°C	
P _D	Power Dissipation	2	W	
I _{OUT}	Short Circuit Output Current	±50	mA	

Caution: Conditions outside the limits listed under "ABSOLUTE MAXIMUM RATINGS" may cause permanent damage to the device. The device is not meant to be operated under conditions outside the limits described in the operational section of this specification.

Exposure to "ABSOLUTE MAXIMUM RATINGS" conditions for extended periods may affect device reliability.

RECOMMENDED DC, AC OPERATING CONDITIONS (Notes: 1) (T_{CASE} = 0°C ~ 85°C)

SYMBOL	PARAMETER	MIN	TYP.	MAX	UNIT	NOTES
V _{DD}	Power Supply Voltage	2.375	2.5	2.625	V	
V _{DDQ}	Power Supply Voltage (for DQ buffer)	1.4	—	1.9	V	
V _{REF}	Reference Voltage	V _{DDQ} /2 × 95%	V _{DDQ} /2	V _{DDQ} /2 × 105%	V	2
V _{IH} (DC)	Input DC High Voltage	V _{REF} + 0.125	—	V _{DDQ} + 0.2	V	5
V _{IL} (DC)	Input DC Low Voltage	-0.1	—	V _{REF} - 0.125	V	5
V _{ICK} (DC)	Differential Clock DC Input Voltage	-0.1	—	V _{DDQ} + 0.1	V	10
V _{ID} (DC)	Differential Input Voltage. CLK and $\overline{\text{CLK}}$ inputs (DC)	0.4	—	V _{DDQ} + 0.2	V	7, 10
V _{IH} (AC)	Input AC High Voltage	V _{REF} + 0.2	—	V _{DDQ} + 0.2	V	3, 6
V _{IL} (AC)	Input AC Low Voltage	-0.1	—	V _{REF} - 0.2	V	4, 6
V _{ID} (AC)	Differential Input Voltage. CLK and $\overline{\text{CLK}}$ inputs (AC)	0.55	—	V _{DDQ} + 0.2	V	7, 10
V _X (AC)	Differential AC Input Cross Point Voltage	V _{DDQ} /2 - 0.125	—	V _{DDQ} /2 + 0.125	V	8, 10
V _{ISO} (AC)	Differential Clock AC Middle Level	V _{DDQ} /2 - 0.125	—	V _{DDQ} /2 + 0.125	V	9, 10

NOTES:

- (1) All voltages referenced to VSS, VSSQ.
- (2) VREF is expected to track variations in VDDQ DC level of the transmitting device. Peak to peak AC noise on VREF may not exceed ±2% VREF (DC).
- (3) Overshoot limit: $V_{IH} (max) = V_{DDQ} + 0.7 V$ with a pulse width ≤ 5 ns.
- (4) Undershoot limit: $V_{IL} (min) = -0.7 V$ with a pulse width ≤ 5 ns.
- (5) $V_{IH} (DC)$ and $V_{IL} (DC)$ are levels to maintain the current logic state.
- (6) $V_{IH} (AC)$ and $V_{IL} (AC)$ are levels to change to the new logic state.
- (7) VID is differential voltage of CLK input level and \overline{CLK} input level.
- (8) The value of $V_X (AC)$ is expected to equal $V_{DDQ}/2$ of the transmitting device.
- (9) VISO means $\{V_{ICK} (CLK) + V_{ICK} (\overline{CLK})\} / 2$
- (10) Refer to the figure below.

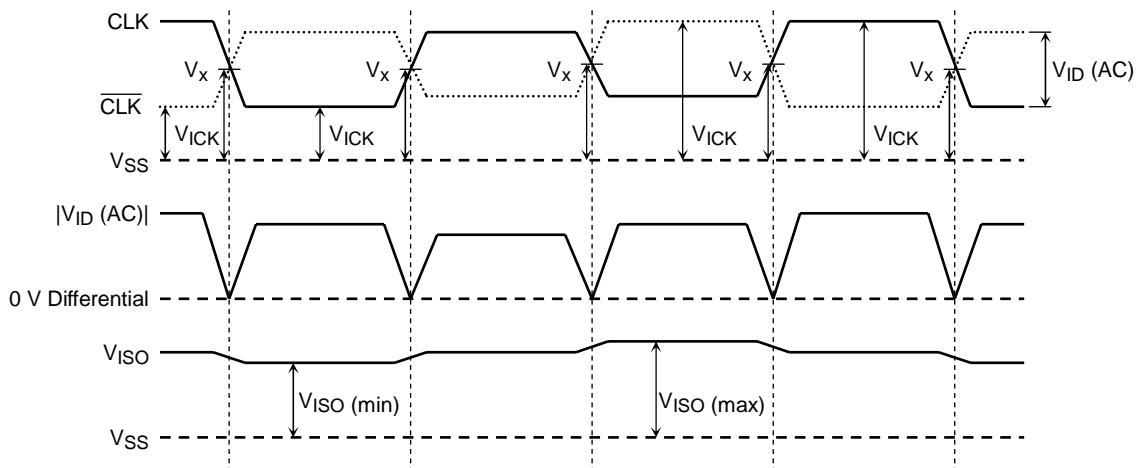

- (11) In the case of external termination, VTT (termination voltage) should be gone in the range of VREF (DC) ± 0.04 V.

CAPACITANCE ($V_{DD} = 2.5V, V_{DDQ} = 1.8 V, f = 1 MHz, T_a = 25^\circ C$)

SYMBOL	PARAMETER	MIN	MAX	Delta	UNIT
C_{IN}	Input pin Capacitance	1.5	3.0	0.25	pF
C_{INC}	Clock pin (CLK, \overline{CLK}) Capacitance	1.5	3.0	0.25	pF
$C_{I/O}$	DQ, DS, QS Capacitance	2.5	3.5	0.5	pF
C_{NC}	NC pin Capacitance	—	1.5	—	pF

Note: These parameters are periodically sampled and not 100% tested.

RECOMMENDED DC OPERATING CONDITIONS

($V_{DD} = 2.5\text{ V} \pm 0.125\text{ V}$, $V_{DDQ} = 1.4\text{ V} \sim 1.9\text{ V}$, $T_{CASE} = 0 \sim 85^{\circ}\text{C}$)

SYMBOL	PARAMETER	MAX		UNIT	NOTES
		-33	-40		
I_{DD1S}	Operating Current One bank read or write operation ; $t_{CK} = \text{min}$; $I_{RC} = \text{min}$, $I_{OUT} = 0\text{mA}$; Burst Length = 4, CAS Latency = 6, Free running QS mode ; $0\text{ V} \leq V_{IN} \leq V_{IL}(\text{AC})(\text{max})$, $V_{IH}(\text{AC})(\text{min}) \leq V_{IN} \leq V_{DDQ}$; Address inputs change up to 2 times during minimum I_{RC} ; Read data change twice per clock cycle	235	210	mA	1, 2
I_{DD2N}	Standby Current All banks: inactive state ; $t_{CK} = \text{min}$, $\overline{CS} = V_{IH}$, $\overline{PD} = V_{IH}$; $0\text{ V} \leq V_{IN} \leq V_{IL}(\text{AC})(\text{max})$, $V_{IH}(\text{AC})(\text{min}) \leq V_{IN} \leq V_{DDQ}$; Other input signals change one time during $4 \times t_{CK}$; DQ and DS inputs change twice per clock cycle	95	90		1, 2
I_{DD2P}	Standby (power down) Current All banks: inactive state ; $t_{CK} = \text{min}$, $\overline{PD} = V_{IL}(\text{power down})$; CAS Latency = 6, Free running QS mode ; $0\text{ V} \leq V_{IN} \leq V_{IL}(\text{AC})(\text{max})$, $V_{IH}(\text{AC})(\text{min}) \leq V_{IN} \leq V_{DDQ}$; Other input signals change one time during $4 \times t_{CK}$; DQ and DS inputs are floating ($V_{DDQ}/2$)	65	60		1, 2
I_{DD4W}	Write Operating Current (4Banks) 4 Bank interleaved continuous burst write operation ; $t_{CK} = \text{min}$, $I_{RC} = \text{min}$; Burst Length = 4, CAS Latency = 6, Free running QS mode ; $0\text{ V} \leq V_{IN} \leq V_{IL}(\text{AC})(\text{max})$, $V_{IH}(\text{AC})(\text{min}) \leq V_{IN} \leq V_{DDQ}$; Address inputs change once per clock cycle, DQ and DS inputs change twice per clock cycle	450	400		1, 2
I_{DD4R}	Read Operating Current (4Banks) 4 Bank interleaved continuous burst read operation ; $t_{CK} = \text{min}$, $I_{RC} = \text{min}$, $I_{OUT} = 0\text{mA}$; Burst Length = 4, CAS Latency = 6, Free running QS mode ; $0\text{ V} \leq V_{IN} \leq V_{IL}(\text{AC})(\text{max})$, $V_{IH}(\text{AC})(\text{min}) \leq V_{IN} \leq V_{DDQ}$; Address inputs change once per clock cycle, Read data change twice per clock cycle	450	400		1, 2
I_{DD5B}	Burst Auto Refresh Current Refresh command at every I_{REFC} interval ; $t_{CK} = \text{min}$; $I_{REFC} = \text{min}$; CAS Latency = 6, Free running QS mode ; $0\text{ V} \leq V_{IN} \leq V_{IL}(\text{AC})(\text{max})$, $V_{IH}(\text{AC})(\text{min}) \leq V_{IN} \leq V_{DDQ}$; Address inputs change up to 2 times during minimum I_{REFC} ; DQ and DS inputs change twice per clock cycle	235	210		1, 2, 3
I_{DD6}	Self-Refresh Current $\overline{PD} = 0.2\text{ V}$; Other input signals are floating ($V_{DDQ}/2$), DQ and DS inputs are floating ($V_{DDQ}/2$)	15	15		2

- Notes: 1. These parameters depend on the cycle rate and these values are measured at a cycle rate with the minimum values of t_{CK} , t_{RC} and I_{RC} .
2. These parameters define the current between V_{DD} and V_{SS} .
3. I_{DD5B} is specified under burst refresh condition. Actual system should use distributed refresh that meet to t_{REFI} specification.

RECOMMENDED DC OPERATING CONDITIONS (continued)

($V_{DD} = 2.5\text{ V} \pm 0.125\text{ V}$, $V_{DDQ} = 1.4\text{ V} \sim 1.9\text{ V}$, $T_{CASE} = 0 \sim 85^{\circ}\text{C}$)

SYMBOL	PARAMETER		MIN	MAX	UNIT	NOTES	
I_{LI}	Input Leakage Current ($0\text{ V} \leq V_{IN} \leq V_{DDQ}$, all other pins not under test = 0 V)		-5	5	μA		
I_{LO}	Output Leakage Current (Output disabled, $0\text{ V} \leq V_{OUT} \leq V_{DDQ}$)		-5	5	μA		
I_{REF}	V_{REF} Current		-5	5	μA		
I_{OH} (DC)	Normal Output Driver	Output DC Current ($V_{DDQ} = 1.7\text{V} \sim 1.9\text{V}$)	$V_{OH} = 1.420\text{ V}$	-5.6	—	mA	1
I_{OL} (DC)			$V_{OL} = 0.280\text{ V}$	5.6	—		
I_{OH} (DC)	Strong Output Driver		$V_{OH} = 1.420\text{ V}$	-9.8	—		
I_{OL} (DC)			$V_{OL} = 0.280\text{ V}$	9.8	—		
I_{OH} (DC)	Weak Output Driver		$V_{OH} = 1.420\text{ V}$	-2.8	—		
I_{OL} (DC)			$V_{OL} = 0.280\text{ V}$	2.8	—		
I_{OH} (DC)	Normal Output Driver	Output DC Current ($V_{DDQ} = 1.4\text{V} \sim 1.6\text{V}$)	$V_{OH} = V_{DDQ} - 0.4\text{V}$	-4	—	mA	1
I_{OL} (DC)			$V_{OL} = 0.4\text{V}$	4	—		
I_{OH} (DC)	Strong Output Driver		$V_{OH} = V_{DDQ} - 0.4\text{V}$	-8	—		
I_{OL} (DC)			$V_{OL} = 0.4\text{V}$	8	—		
I_{OH} (DC)	Weak Output Driver		Not defined	—	—		
I_{OL} (DC)			Not defined	—	—		

Notes: 1. Refer to output driver characteristics for the detail. Output Driver Strength is selected by Extended Mode Register.

AC CHARACTERISTICS AND OPERATING CONDITIONS (Notes: 1, 2)

($V_{DD} = 2.5\text{ V} \pm 0.125\text{V}$, $V_{DDQ} = 1.4\text{V} \sim 1.9\text{V}$, $T_{CASE} = 0 \sim 85^{\circ}\text{C}$)

SYMBOL	PARAMETER	-33		-40		UNIT	NOTES	
		MIN	MAX	MIN	MAX			
t _{RC}	Random Cycle Time	22.5	—	25	—	ns	3	
t _{CK}	Clock Cycle Time	C _L = 4	4.5	7.5	5.0		7.5	3
		C _L = 5	3.75	7.5	4.5		7.5	3
		C _L = 6	3.33	7.5	4.0		7.5	3
t _{RAC}	Random Access Time	—	22.5	—	25		3	
t _{CH}	Clock High Time	0.45 × t _{CK}	—	0.45 × t _{CK}	—		3	
t _{CL}	Clock Low Time	0.45 × t _{CK}	—	0.45 × t _{CK}	—		3	
t _{CKQS}	QS Access Time from CLK	-0.45	0.45	-0.6	0.6		3, 8, 10	
t _{QSQ}	Data Output Skew from QS	—	0.25	—	0.3			
t _{AC}	Data Access Time from CLK	-0.5	0.5	-0.65	0.65		3, 8, 10	
t _{OH}	Data Output Hold Time from CLK	-0.5	0.5	-0.65	0.65		3, 8	
t _{HP}	CLK half period (minimum of Actual t _{CH} , t _{CL})	min (t _{CH} , t _{CL})	—	min (t _{CH} , t _{CL})	—		3	
t _{QSP}	QS (read) Pulse Width	t _{HP} -t _{QHS}	—	t _{HP} -t _{QHS}	—		4, 8	
t _{QSQV}	Data Output Valid Time from QS	t _{HP} - t _{QHS}	—	t _{HP} - t _{QHS}	—		4, 8	
t _{QHS}	DQ, QS Hold Skew factor	—	0.055×t _{CK} + 0.17	—	0.055×t _{CK} + 0.17			
t _{DQSS}	DS (write) Low to High Setup Time	0.8 × t _{CK}	1.2 × t _{CK}	0.8 × t _{CK}	1.2 × t _{CK}		3	
t _{DSPRE}	DS (write) Preamble Pulse Width	0.4 × t _{CK}	—	0.4 × t _{CK}	—		4	
t _{DSPRES}	DS First Input Setup Time	0	—	0	—		3	
t _{DSPREH}	DS First Low Input Hold Time	0.3 × t _{CK}	—	0.3 × t _{CK}	—		3	
t _{DSP}	DS High or Low Input Pulse Width	0.45 × t _{CK}	0.55 × t _{CK}	0.45 × t _{CK}	0.55 × t _{CK}		4	
t _{DSS}	DS Input Falling Edge to Clock Setup Time	C _L = 4	0.8	—	1.0		—	3, 4
		C _L = 5	0.8	—	1.0		—	3, 4
		C _L = 6	0.8	—	1.0		—	3, 4
t _{DSPST}	DS (write) Postamble Pulse Width	0.45 × t _{CK}	—	0.45 × t _{CK}	—	4		
t _{DSPSTH}	DS (write) Postamble Hold Time	C _L = 4	0.8	—	1.0	—	3, 4	
		C _L = 5	0.8	—	1.0	—	3, 4	
		C _L = 6	0.8	—	1.0	—	3, 4	
t _{DS}	Data Input Setup Time from DS	0.35	—	0.4	—	4		
t _{DH}	Data Input Hold Time from DS	0.35	—	0.4	—	4		
t _{IS}	Command/Address Input Setup Time	0.6	—	0.7	—	3		
t _{IH}	Command/Address Input Hold Time	0.6	—	0.7	—	3		
t _{LZ}	Data-out Low Impedance Time from CLK	-0.5	—	-0.65	—	3,6,8		
t _{HZ}	Data-out High Impedance Time from CLK	—	0.5	—	0.65	3,7,8		

AC CHARACTERISTICS AND OPERATING CONDITIONS (Notes: 1, 2) (continued)

SYMBOL	PARAMETER	-33		-40		UNIT	NOTES
		MIN	MAX	MIN	MAX		
t _{QPDH}	Last output to \overline{PD} High Hold Time	0	—	0	—	ns	
t _{PDEX}	Power Down Exit Time	0.6	—	0.7	—		3
t _T	Input Transition Time	0.1	1	0.1	1		
t _{FPDL}	\overline{PD} Low Input Window for Self-Refresh Entry	$-0.5 \times t_{CK}$	5	$-0.5 \times t_{CK}$	5		3
t _{REFI}	Auto-Refresh Average Interval	0.4	3.9	0.4	3.9	μ s	5
t _{PAUSE}	Pause Time after Power-up	200	—	200	—		
t _{RC}	Random Read/Write Cycle Time (applicable to same bank)	C _L = 4	5	—	5	cycle	
		C _L = 5	6	—	6		
		C _L = 6	7	—	7		
t _{RCD}	RDA/WRA to LAL Command Input Delay (applicable to same bank)	1	1	1	1		
t _{RAS}	LAL to RDA/WRA Command Input Delay (applicable to same bank)	C _L = 4	4	—	4		
		C _L = 5	5	—	5		
		C _L = 6	6	—	6		
t _{RBD}	Random Bank Access Delay (applicable to other bank)	2	—	2	—		
t _{RWD}	LAL following RDA to WRA Delay (applicable to other bank)	B _L = 2	2	—	2		
		B _L = 4	3	—	3		
t _{WRD}	LAL following WRA to RDA Delay (applicable to other bank)	1	—	1	—		
t _{RSC}	Mode Register Set Cycle Time	C _L = 4	7	—	7		
		C _L = 5	7	—	7		
		C _L = 6	7	—	7		
t _{PD}	\overline{PD} Low to Inactive State of Input Buffer	—	2	—	2		
t _{PDA}	\overline{PD} High to Active State of Input Buffer	1	—	1	—		
t _{PDV}	Power down mode valid from REF command	C _L = 4	19	—	19		
		C _L = 5	23	—	23		
		C _L = 6	25	—	25		
t _{REFC}	Auto-Refresh Cycle Time	C _L = 4	19	—	19		
		C _L = 5	23	—	23		
		C _L = 6	25	—	25		
t _{CKD}	REF Command to Clock Input Disable at Self-Refresh Entry	t _{REFC}	—	t _{REFC}	—		
t _{LOCK}	DLL Lock-on Time (applicable to RDA command)	200	—	200	—		

AC TEST CONDITIONS

SYMBOL	PARAMETER	VALUE	UNIT	NOTES
$V_{IH} \text{ (min)}$	Input High Voltage (minimum)	$V_{REF} + 0.2$	V	
$V_{IL} \text{ (max)}$	Input Low Voltage (maximum)	$V_{REF} - 0.2$	V	
V_{REF}	Input Reference Voltage	$V_{DDQ}/2$	V	
V_{TT}	Termination Voltage	V_{REF}	V	
V_{SWING}	Input Signal Peak to Peak Swing	0.8	V	
V_r	Differential Clock Input Reference Level	$V_X \text{ (AC)}$	V	
$V_{ID} \text{ (AC)}$	Input Differential Voltage	1.0	V	
SLEW	Input Signal Minimum Slew Rate	2.5	V/ns	
V_{OTR}	Output Timing Measurement Reference Voltage	$V_{DDQ}/2$	V	9

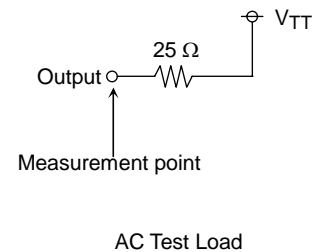
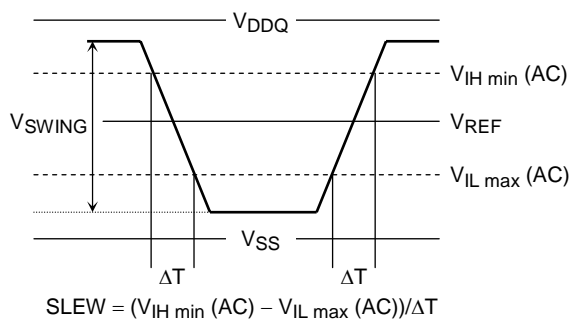

NOTES:

- (1) Transition times are measured between $V_{IH \text{ min (DC)}}$ and $V_{IL \text{ max (DC)}}$.
Transition (rise and fall) of input signals have a fixed slope.
- (2) If the result of nominal calculation with regard to t_{CK} contains more than one decimal place, the result is rounded up to the nearest decimal place.
(i.e., $t_{DQSS} = 0.8 \times t_{CK}$, $t_{CK} = 3.3 \text{ ns}$, $0.8 \times 3.3 \text{ ns} = 2.64 \text{ ns}$ is rounded up to 2.7 ns.)
- (3) These parameters are measured from the differential clock (CLK and $\overline{\text{CLK}}$) AC cross point.
- (4) These parameters are measured from signal transition point of DS crossing V_{REF} level.
- (5) The $t_{REFI} \text{ (max)}$ applies to equally distributed refresh method.
The $t_{REFI} \text{ (min)}$ applies to both burst refresh method and distributed refresh method.
In such case, the average interval of eight consecutive Auto-Refresh commands has to be more than 400 ns always. In other words, the number of Auto-Refresh cycles which can be performed within 3.2 μs ($8 \times 400 \text{ ns}$) is to 8 times in the maximum.
- (6) Low Impedance State is specified at $V_{DDQ}/2 \pm 0.1 \text{ V}$ from steady state.
- (7) High Impedance State is specified where output buffer is no longer driven.
- (8) These parameters depend on the clock jitter. These parameters are measured at stable clock.
- (9) Output timing is measured by using Normal driver strength at $V_{DDQ} = 1.7 \text{ V} \sim 1.9 \text{ V}$.
Output timing is measured by using Strong driver strength at $V_{DDQ} = 1.4 \text{ V} \sim 1.6 \text{ V}$.
- (10) These parameters are measured at $t_{CK} = \text{minimum} \sim 6.0 \text{ ns}$. When t_{CK} is longer than 6.0 ns, these parameters are specified as below for all speed version.

$$t_{CKQS} \text{ (MIN/MAX)} = -0.6 \text{ ns} / 0.6 \text{ ns}, t_{AC} \text{ (MIN/MAX)} = -0.65 \text{ ns} / 0.65 \text{ ns}$$

POWER UP SEQUENCE

- (1) As for \overline{PD} , being maintained by the low state ($\leq 0.2\text{ V}$) is desirable before a power-supply injection.
- (2) Apply V_{DD} before or at the same time as V_{DDQ} .
- (3) Apply V_{DDQ} before or at the same time as V_{REF} .
- (4) Start clock (CLK, \overline{CLK}) and maintain stable condition for 200 μs (min).
- (5) After stable power and clock, apply DESL and take $\overline{PD} = \text{H}$.
- (6) Issue EMRS to enable DLL and to define driver strength and data strobe type. (Note: 1)
- (7) Issue MRS for set \overline{CAS} latency (CL), Burst Type (BT), and Burst Length (BL). (Note: 1)
- (8) Issue two or more Auto-Refresh commands (Note: 1).
- (9) Ready for normal operation after 200 clocks from Extended Mode Register programming.

NOTES:

- (1) Sequence 6, 7 and 8 can be issued in random order.
- (2) L = Logic Low, H = Logic High
- (3) DQ output is Hi-Z state during power upsequence.

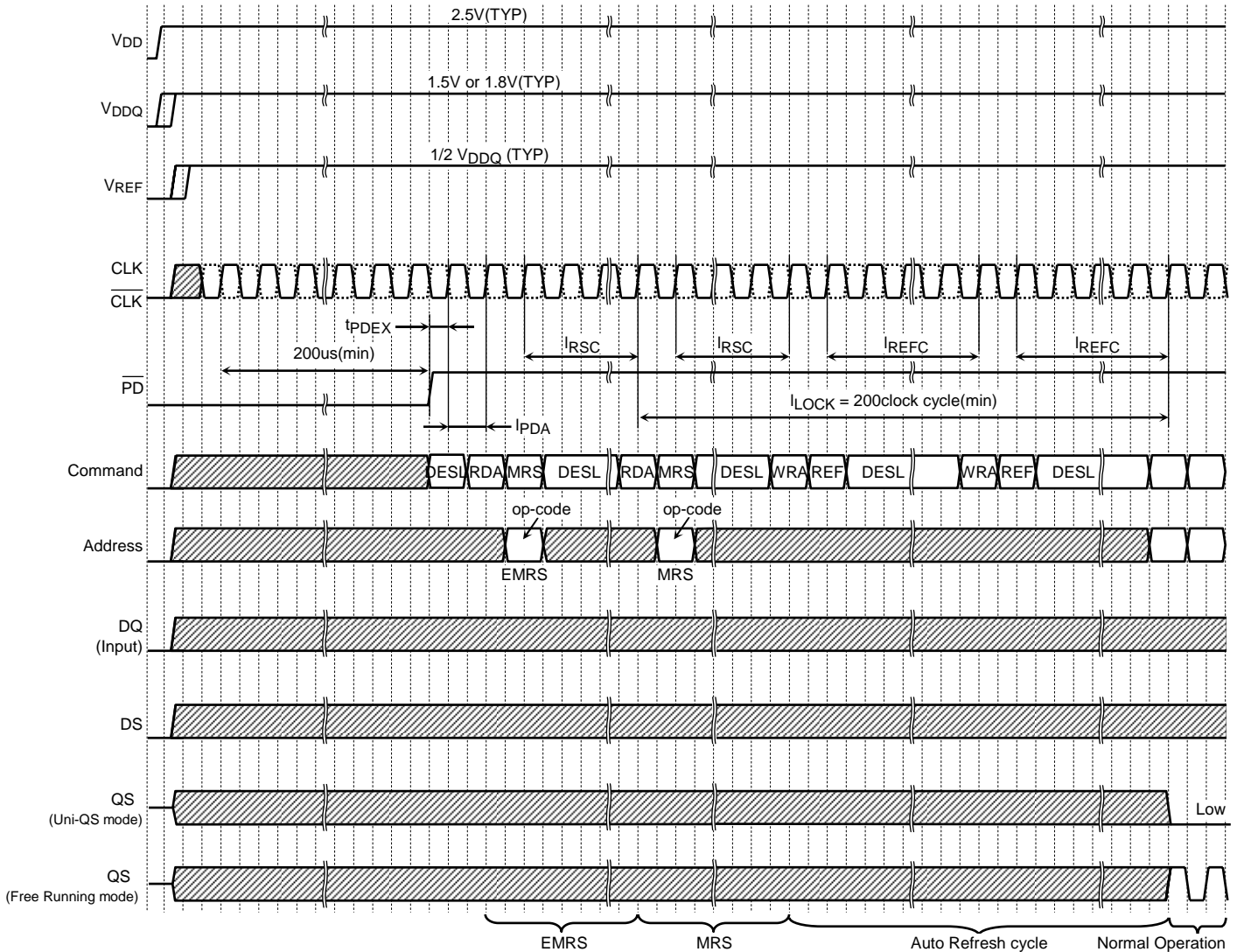

TIMING DIAGRAMS

Input Timing

Command and Address

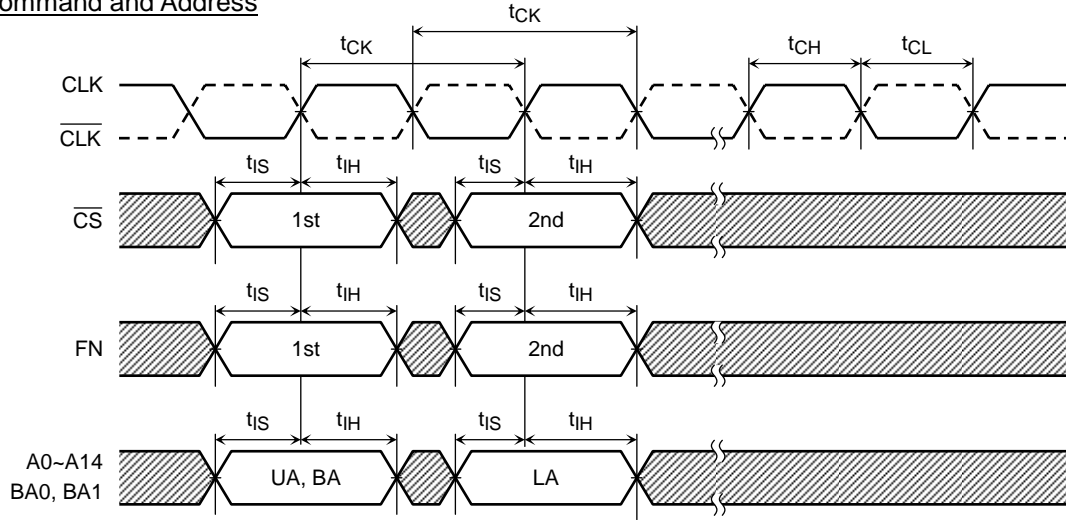

Data

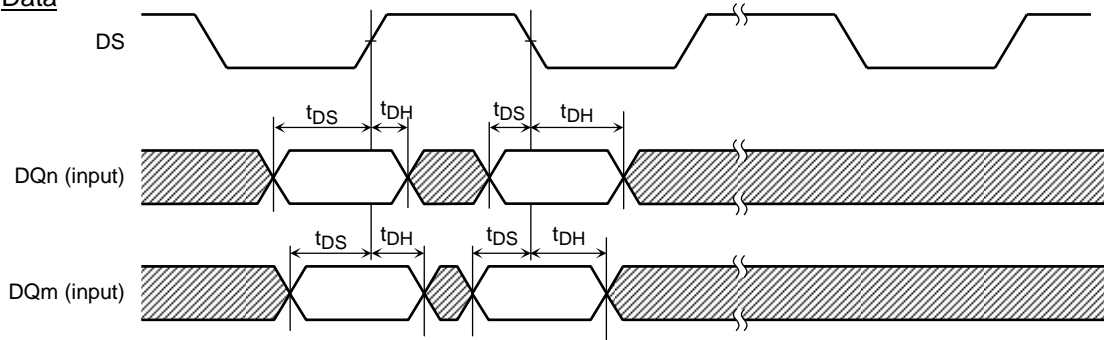

Refer to the Command Truth Table.

Timing of the CLK, \overline{CLK}

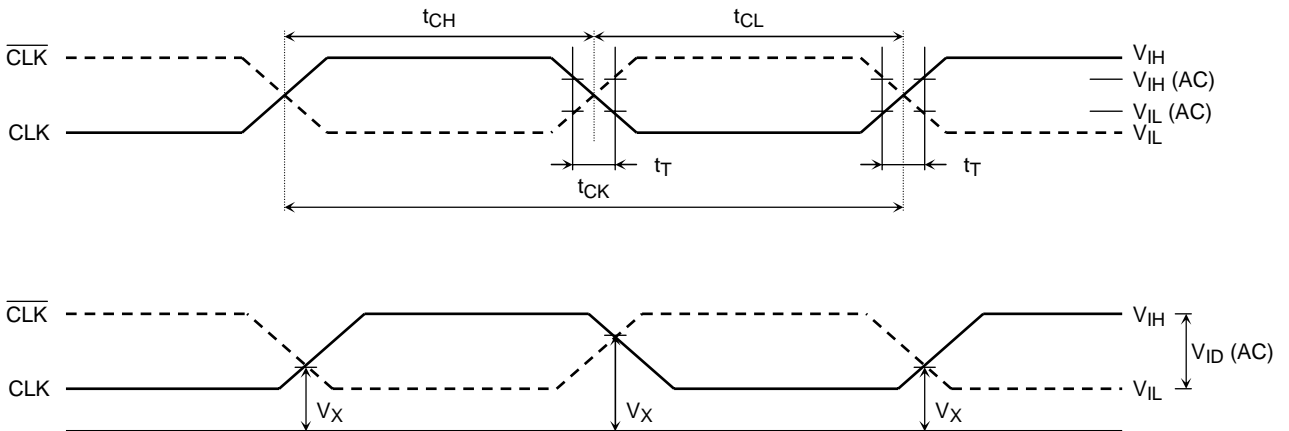

Read Timing (Burst Length = 4)

Unidirectional DS/QS mode

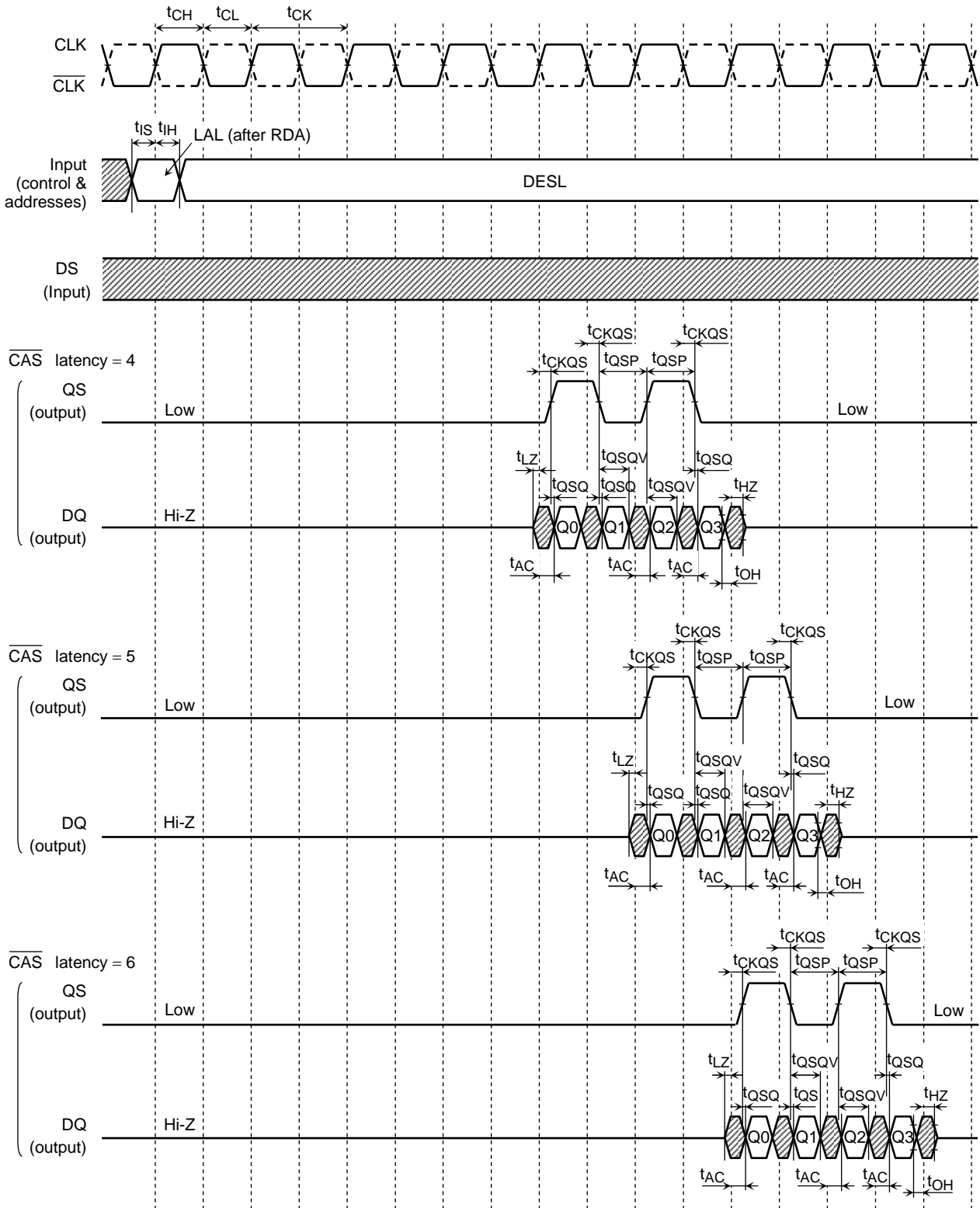

Note: DQ0 to DQ17 are aligned with QS.

Read Timing (Burst Length = 4)

Unidirectional DS/Free Running QS mode

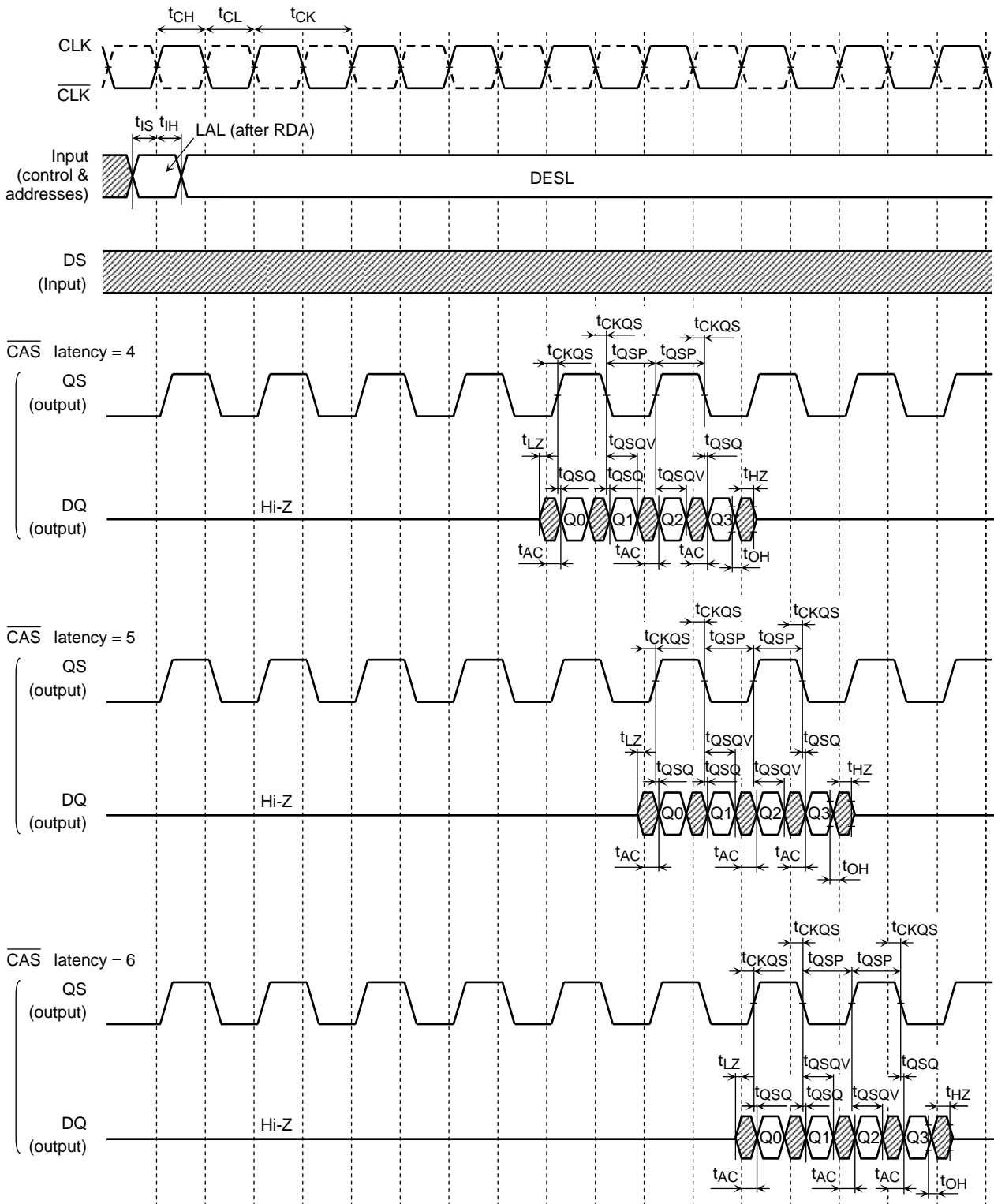

Note: DQ0 to DQ17 are aligned with QS.
 QS is always asserted in Free Running QS mode.

Write Timing (Burst Length = 4)

Unidirectional DS/QS mode, Unidirectional DS/Free Running QS mode

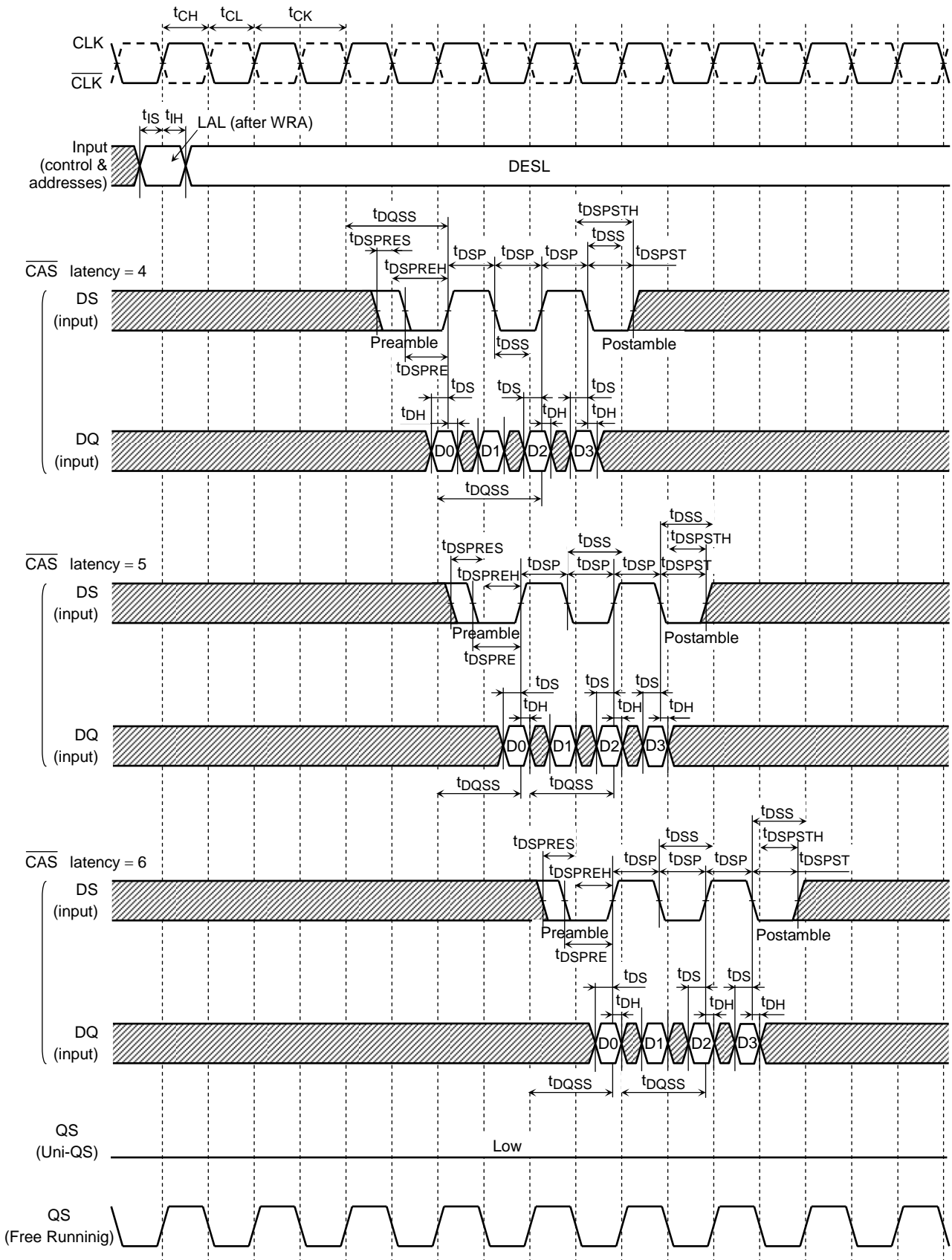

Note: DQ0 to DQ17 are sampled at both edges of DS.

tREFI, tPAUSE, tXXXX Timing

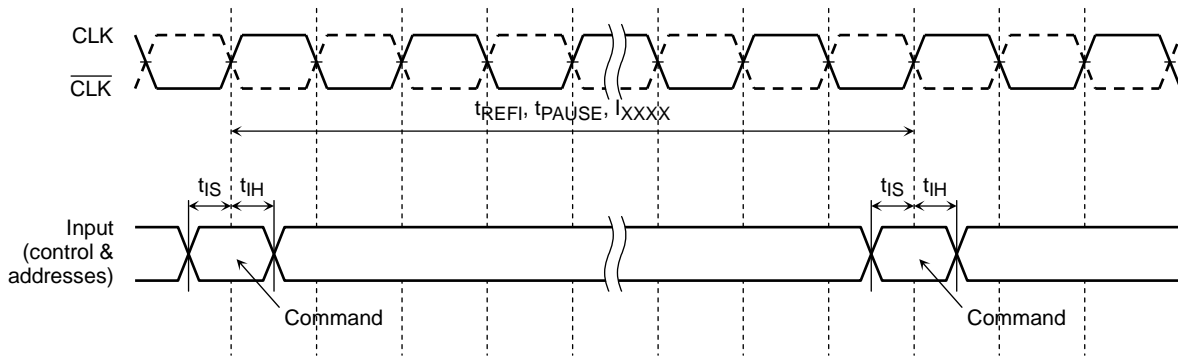

Note: "t_{XXXX}" means "t_{RC}", "t_{RCD}", "t_{RAS}", etc.

FUNCTION TRUTH TABLE (Notes: 1, 2, 3)

Command Truth Table (Notes: 4)

• The First Command

SYMBOL	FUNCTION	\overline{CS}	FN	BA1~BA0	A14~A9	A8	A7	A6~A0
DESL	Device Deselect	H	×	×	×	×	×	×
RDA	Read with Auto-close	L	H	BA	UA	UA	UA	UA
WRA	Write with Auto-close	L	L	BA	UA	UA	UA	UA

• The Second Command (The next clock of RDA or WRA command)

SYMBOL	FUNCTION	\overline{CS}	FN	BA1~BA0	A14~A13	A12~A11	A10~A9	A8	A7	A6~A0
LAL	Lower Address Latch	H	×	×	V	×	×	×	×	LA
REF	Auto-Refresh	L	×	×	×	×	×	×	×	×
MRS	Mode Register Set	L	×	V	L	L	L	L	V	V

- Notes: 1. L = Logic Low, H = Logic High, × = either L or H, V = Valid (specified value), BA = Bank Address, UA = Upper Address, LA = Lower Address
 2. All commands are assumed to issue at a valid state.
 3. All inputs for command (excluding SELFX and PDEX) are latched on the crossing point of differential clock input where CLK goes to High.
 4. Operation mode is decided by the combination of 1st command and 2nd command. Refer to "STATE DIAGRAM" and the command table below.

Read Command Table

COMMAND (SYMBOL)	\overline{CS}	FN	BA1~BA0	A14~A9	A8	A7	A6~A0	NOTES
RDA (1st)	L	H	BA	UA	UA	UA	UA	
LAL (2nd)	H	×	×	×	×	×	LA	

Write Command Table

COMMAND(SYMBOL)	\overline{CS}	FN	BA1~BA0	A14	A13	A12	A11	A10~A9	A8	A7	A6~A0
WRA (1st)	L	L	BA	UA	UA	UA	UA	UA	UA	UA	UA
LAL (2nd)	H	×	×	VW0	VW1	×	×	×	×	×	LA

- Notes: 5. A14- A13 are used for Variable Write Length (VW) control at Write Operation.

VW Truth Table

Burst Length	Function	VW0	VW1
BL=2	Write All Words	L	×
	Write First One Word	H	×
BL=4	Reserved	L	L
	Write All Words	H	L
	Write First Two Words	L	H
	Write First One Word	H	H

FUNCTION TRUTH TABLE (continued)

Mode Register Set Command Table

COMMAND (SYMBOL)	\overline{CS}	FN	BA1~BA0	A14~A9	A8	A7	A6~A0	NOTES
RDA (1st)	L	H	x	x	x	x	x	
MRS (2nd)	L	x	V	L	L	V	V	6

Notes: 6. Refer to "MODE REGISTER TABLE".

Auto-Refresh Command Table

FUNCTION	COMMAND (SYMBOL)	CURRENT STATE	\overline{PD}		\overline{CS}	FN	BA1~BA0	A14~A9	A8	A7	A6~A0	NOTES
			n-1	n								
Active	WRA (1st)	Standby	H	H	L	L	x	x	x	x	x	
Auto-Refresh	REF (2nd)	Active	H	H	L	x	x	x	x	x	x	

Self-Refresh Command Table

FUNCTION	COMMAND (SYMBOL)	CURRENT STATE	\overline{PD}		\overline{CS}	FN	BA1~BA0	A14~A9	A8	A7	A6~A0	NOTES
			n-1	n								
Active	WRA (1st)	Standby	H	H	L	L	x	x	x	x	x	
Self-Refresh Entry	REF (2nd)	Active	H	L	L	x	x	x	x	x	x	7, 8
Self-Refresh Continue	—	Self Refresh	L	L	x	x	x	x	x	x	x	
Self-Refresh Exit	SELFX	Self Refresh	L	H	H	x	x	x	x	x	x	9

Power Down Table

FUNCTION	COMMAND (SYMBOL)	CURRENT STATE	\overline{PD}		\overline{CS}	FN	BA1~BA0	A14~A9	A8	A7	A6~A0	NOTES
			n-1	n								
Power Down Entry	PDEN	Standby	H	L	H	x	x	x	x	x	x	8
Power Down Continue	—	Power Down	L	L	x	x	x	x	x	x	x	
Power Down Exit	PDEX	Power Down	L	H	H	x	x	x	x	x	x	9

Notes: 7. \overline{PD} has to be brought to Low within t_{FPDL} from REF command.

8. \overline{PD} should be brought to Low after DQ's state turned high impedance.

9. When \overline{PD} is brought to High from Low, this function is executed asynchronously.

FUNCTION TRUTH TABLE (continued)

CURRENT STATE	PD		CS	FN	ADDRESS	COMMAND	ACTION	NOTES
	n-1	n						
Idle	H	H	H	x	x	DESL	NOP	
	H	H	L	H	BA, UA	RDA	Row activate for Read	
	H	H	L	L	BA, UA	WRA	Row activate for Write	
	H	L	H	x	x	PDEN	Power Down Entry	10
	H	L	L	x	x	—	Illegal	
	L	x	x	x	x	—	Refer to Power Down State	
Row Active for Read	H	H	H	x	LA	LAL	Begin Read	
	H	H	L	x	Op-code	MRS/EMRS	Access to Mode Register	
	H	L	H	x	x	PDEN	Illegal	
	H	L	L	x	x	MRS/EMRS	Illegal	
	L	x	x	x	x	—	Invalid	
Row Active for Write	H	H	H	x	LA	LAL	Begin Write	
	H	H	L	x	x	REF	Auto-Refresh	
	H	L	H	x	x	PDEN	Illegal	
	H	L	L	x	x	REF (self)	Self-Refresh Entry	
	L	x	x	x	x	—	Invalid	
Read	H	H	H	x	x	DESL	Continue Burst Read to End	
	H	H	L	H	BA, UA	RDA	Illegal	11
	H	H	L	L	BA, UA	WRA	Illegal	11
	H	L	H	x	x	PDEN	Illegal	
	H	L	L	x	x	—	Illegal	
	L	x	x	x	x	—	Invalid	
Write	H	H	H	x	x	DESL	Data Write&Continue Burst Write to End	
	H	H	L	H	BA, UA	RDA	Illegal	11
	H	H	L	L	BA, UA	WRA	Illegal	11
	H	L	H	x	x	PDEN	Illegal	
	H	L	L	x	x	—	Illegal	
	L	x	x	x	x	—	Invalid	
Auto-Refreshing	H	H	H	x	x	DESL	NOP → Idle after I _{REFC}	
	H	H	L	H	BA, UA	RDA	Illegal	
	H	H	L	L	BA, UA	WRA	Illegal	
	H	L	H	x	x	PDEN	Self-Refresh Entry	12
	H	L	L	x	x	—	Illegal	
	L	x	x	x	x	—	Refer to Self-Refreshing State	
Mode Register Accessing	H	H	H	x	x	DESL	NOP → Idle after I _{RSC}	
	H	H	L	H	BA, UA	RDA	Illegal	
	H	H	L	L	BA, UA	WRA	Illegal	
	H	L	H	x	x	PDEN	Illegal	
	H	L	L	x	x	—	Illegal	
	L	x	x	x	x	—	Invalid	
Power Down	H	x	x	x	x	—	Invalid	
	L	L	x	x	x	—	Maintain Power Down Mode	
	L	H	H	x	x	PDEX	Exit Power Down Mode → Idle after t _{PDEX}	
	L	H	L	x	x	—	Illegal	
Self-Refreshing	H	x	x	x	x	—	Invalid	
	L	L	x	x	x	—	Maintain Self-Refresh	
	L	H	H	x	x	SELFX	Exit Self-Refresh → Idle after I _{REFC}	
	L	H	L	x	x	—	Illegal	

Notes: 10. Illegal if any bank is not idle.

11. Illegal to bank in specified states; Function may be legal in the bank indicated by Bank Address (BA).

12. Illegal if t_{FPDL} is not satisfied.

MODE REGISTER TABLE

Regular Mode Register (Notes: 1)

ADDRESS	BA1 ^{*1}	BA0 ^{*1}	A14~A8	A7 ^{*3}	A6~A4	A3	A2~A0
Register	0	0	0	TE	CL	BT	BL

A7	TEST MODE (TE)
0	Regular (default)
1	Test Mode Entry

A3	BURST TYPE (BT)
0	Sequential
1	Interleave

A6	A5	A4	CAS $\bar{}$ LATENCY (CL)
0	0	×	Reserved ^{*2}
0	1	0	Reserved ^{*2}
0	1	1	Reserved ^{*2}
1	0	0	4
1	0	1	5
1	1	0	6
1	1	1	Reserved ^{*2}

A2	A1	A0	BURST LENGTH (BL)
0	0	0	Reserved ^{*2}
0	0	1	2
0	1	0	4
0	1	1	Reserved ^{*2}
1	×	×	

Extended Mode Register (Notes: 4)

ADDRESS	BA1 ^{*4}	BA0 ^{*4}	A14~A7	A6~A5	A4~A3	A2~A1	A0 ^{*5}
Register	0	1	0	SS	DIC (QS)	DIC (DQ)	DS

A6	A5	STROBE SELECT
0	0	Reserved ^{*2}
0	1	Reserved ^{*2}
1	0	Unidirectional DS/QS
1	1	Unidirectional DS/Free Running QS

QS		DQ		OUTPUT DRIVE IMPEDANCE CONTROL (DIC)
A4	A3	A2	A1	
0	0	0	0	Normal Output Driver
0	1	0	1	Strong Output Driver
1	0	1	0	Weak Output Driver
1	1	1	1	Reserved

A0	DLL SWITCH (DS)
0	DLL Enable
1	DLL Disable

- Notes:
- Regular Mode Register is chosen using the combination of BA0 = 0 and BA1 = 0.
 - "Reserved" places in Regular Mode Register should not be set.
 - A7 in Regular Mode Register must be set to "0" (low state).
Because Test Mode is specific mode for supplier.
 - Extended Mode Register is chosen using the combination of BA0 = 1 and BA1 = 0.
 - A0 in Extended Mode Register must be set to "0" to enable DLL for normal operation.

STATE DIAGRAM

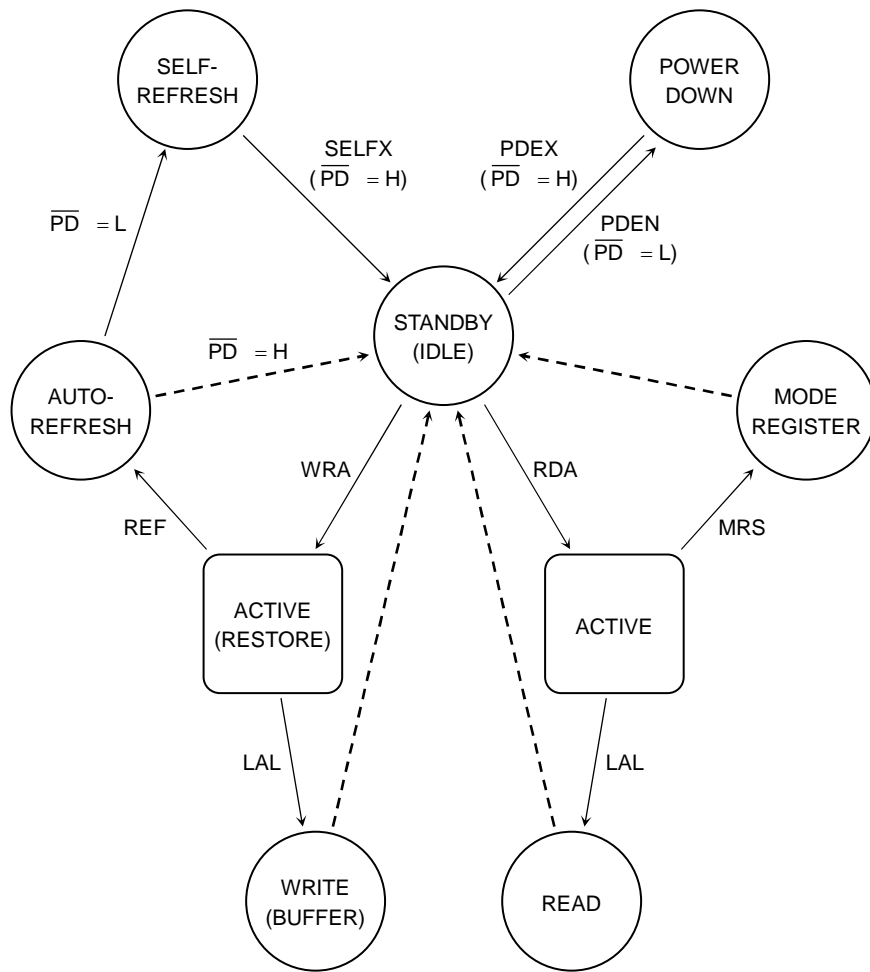

————> Command input
 - - - -> Automatic return

The second command at Active state must be issued 1 clock after RDA or WRA command input.

TIMING DIAGRAMS

SINGLE BANK READ TIMING (CL = 4)

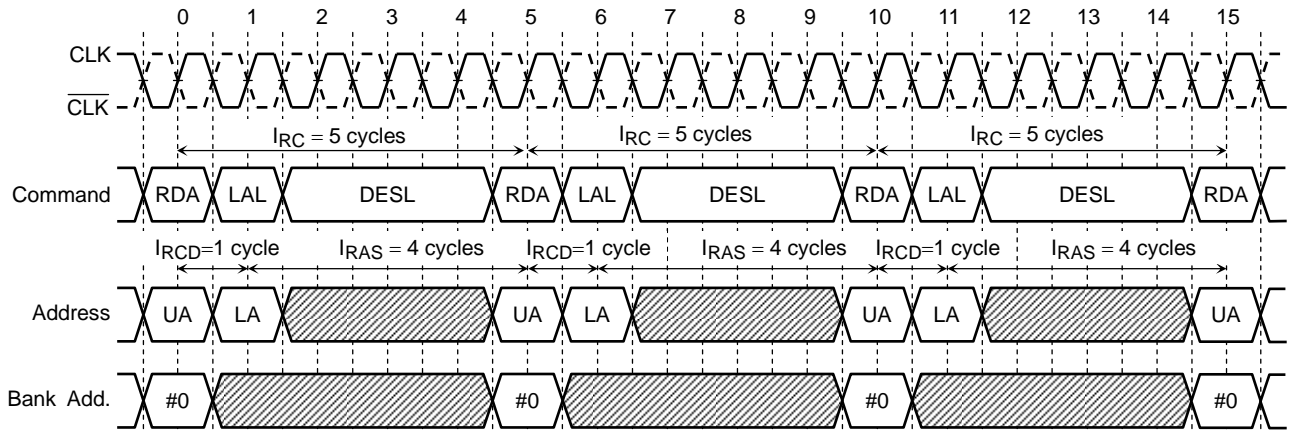

Unidirectional DS/QS mode

BL = 2

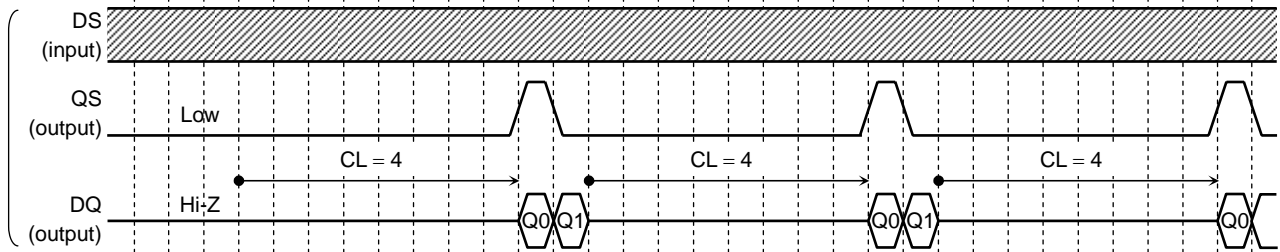

BL = 4

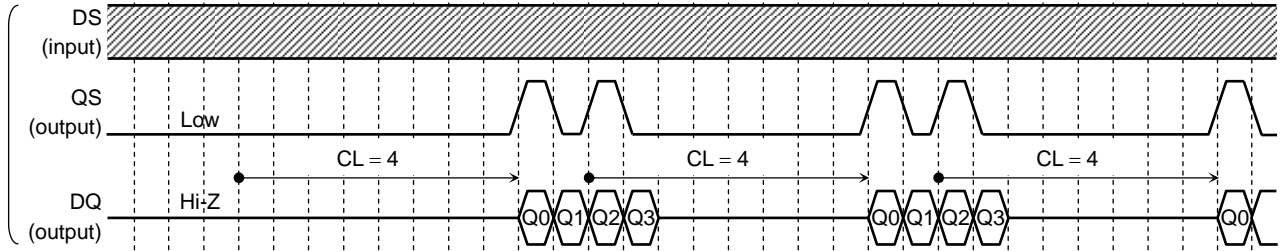

Unidirectional DS/Free Running QS mode

BL = 2

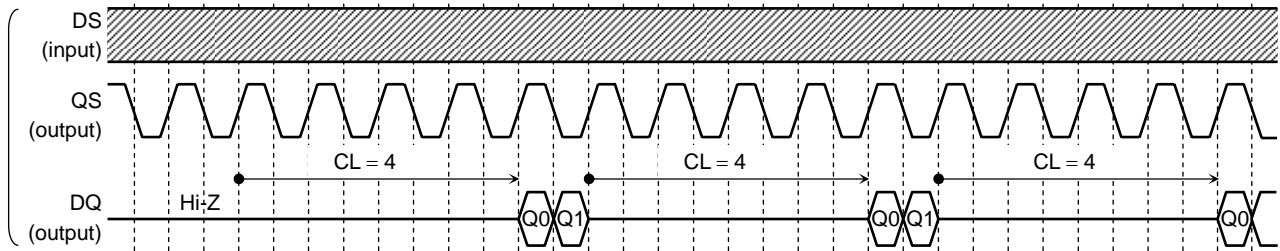

BL = 4

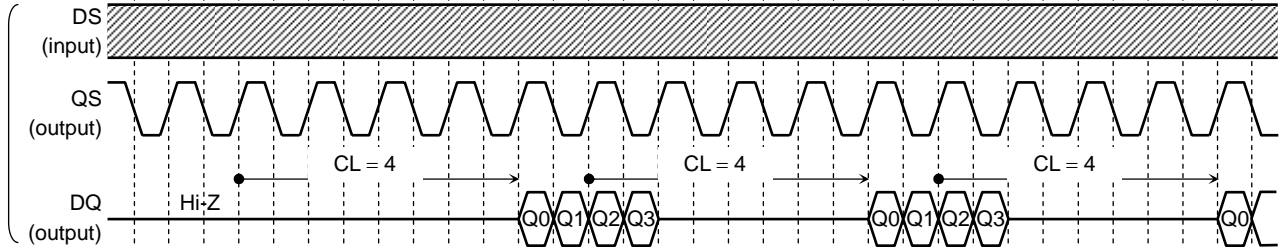

SINGLE BANK READ TIMING (CL = 5)

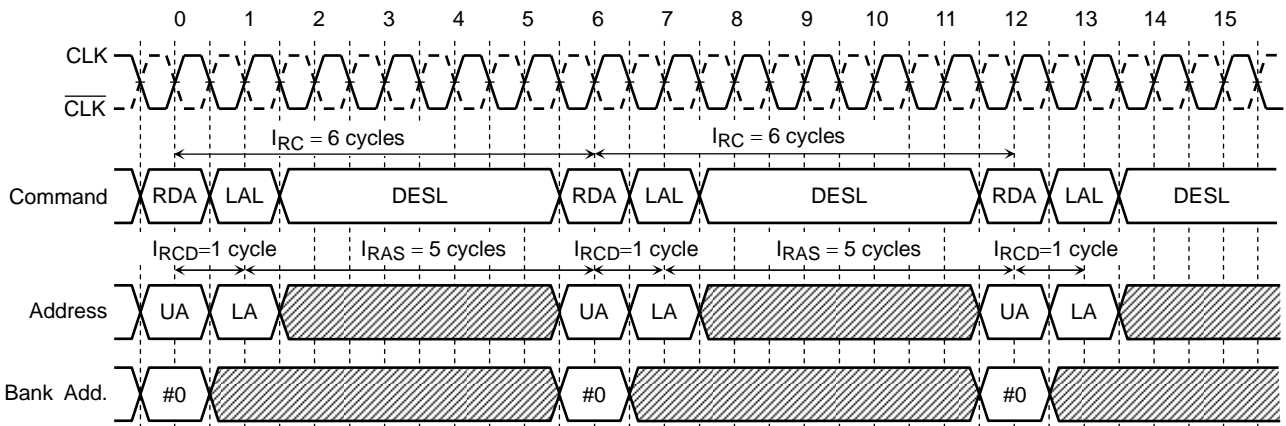

Unidirectional DS/QS mode

BL = 2

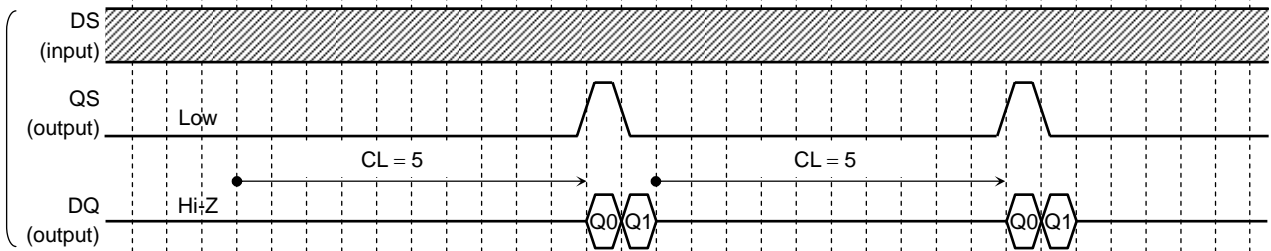

BL = 4

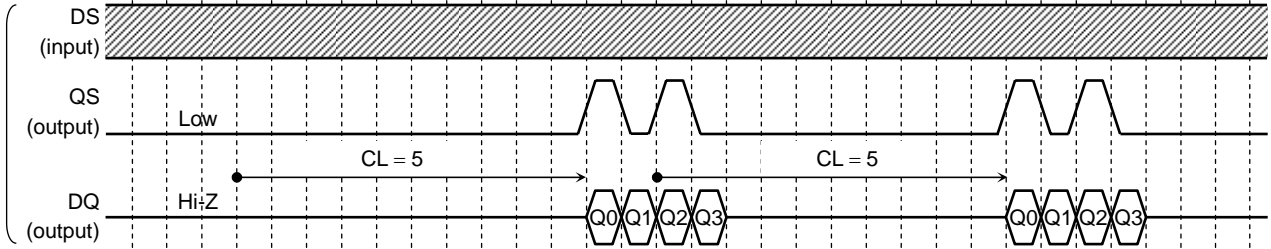

Unidirectional DS/Free Running QS mode

BL = 2

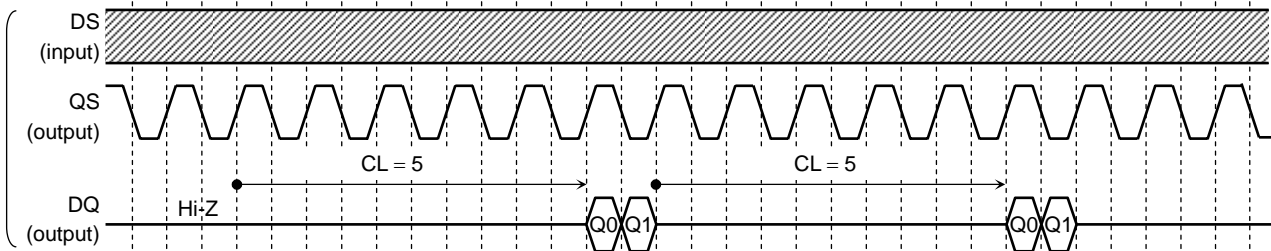

BL = 4

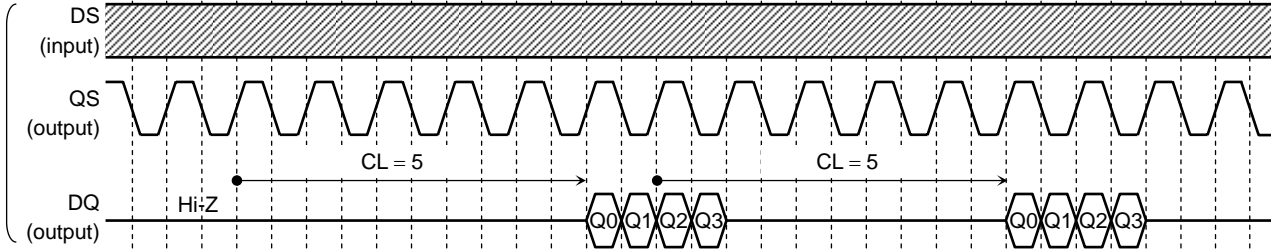

SINGLE BANK READ TIMING (CL = 6)

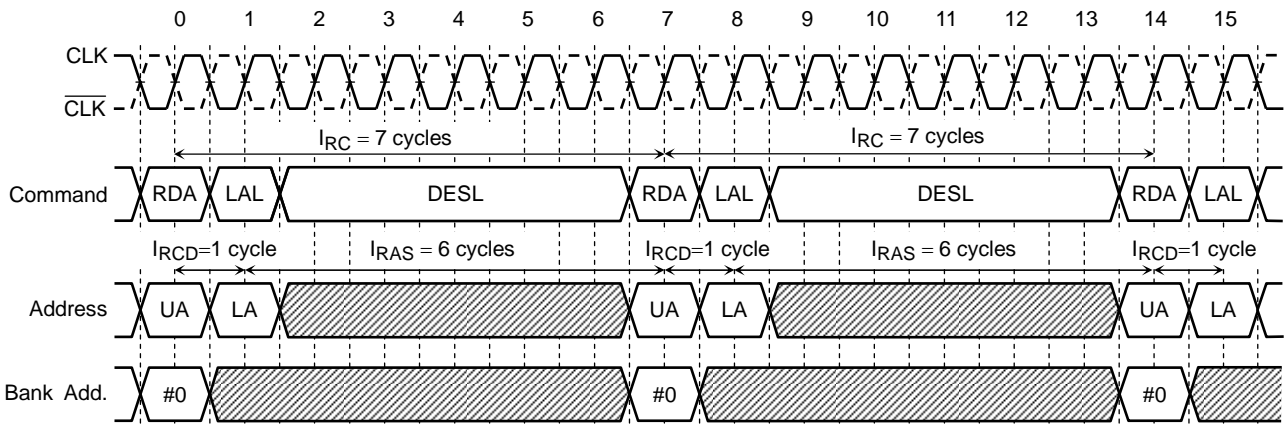

Unidirectional DS/QS mode

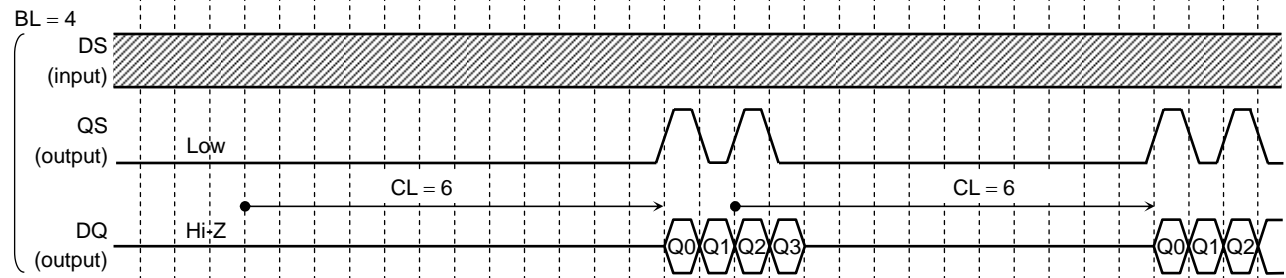
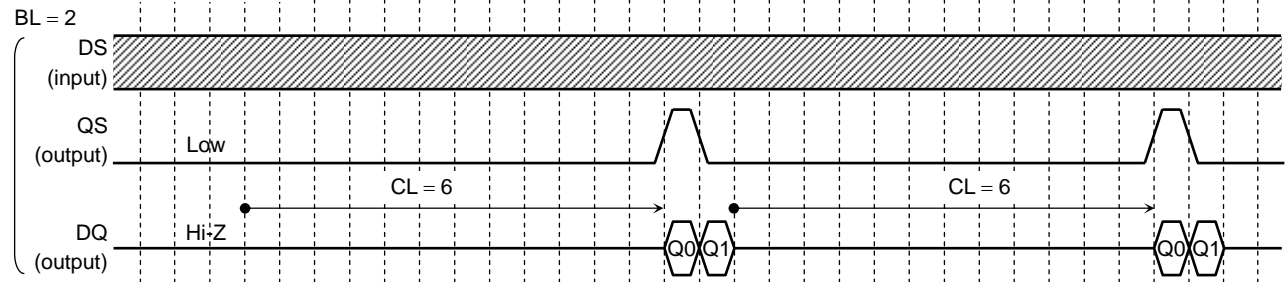

Unidirectional DS/Free Running QS mode

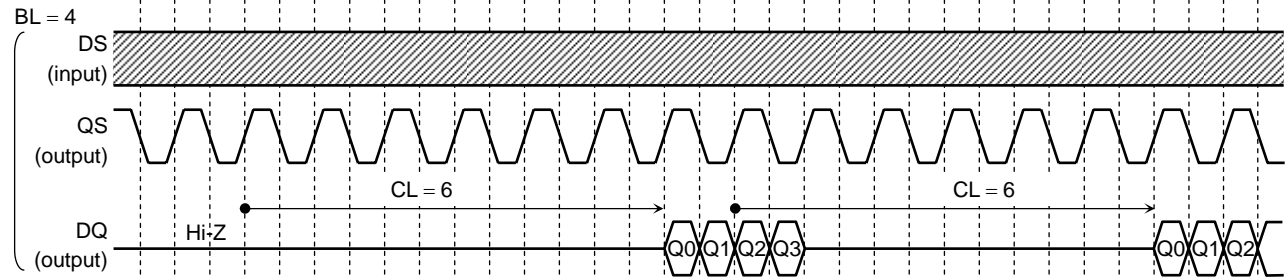
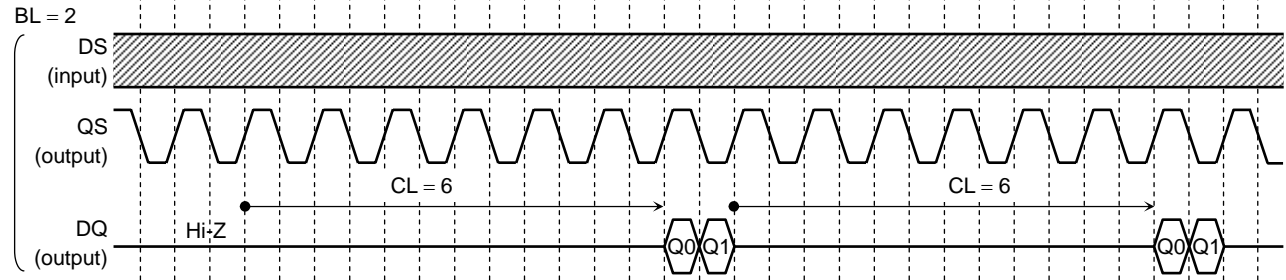

SINGLE BANK WRITE TIMING (CL = 4)

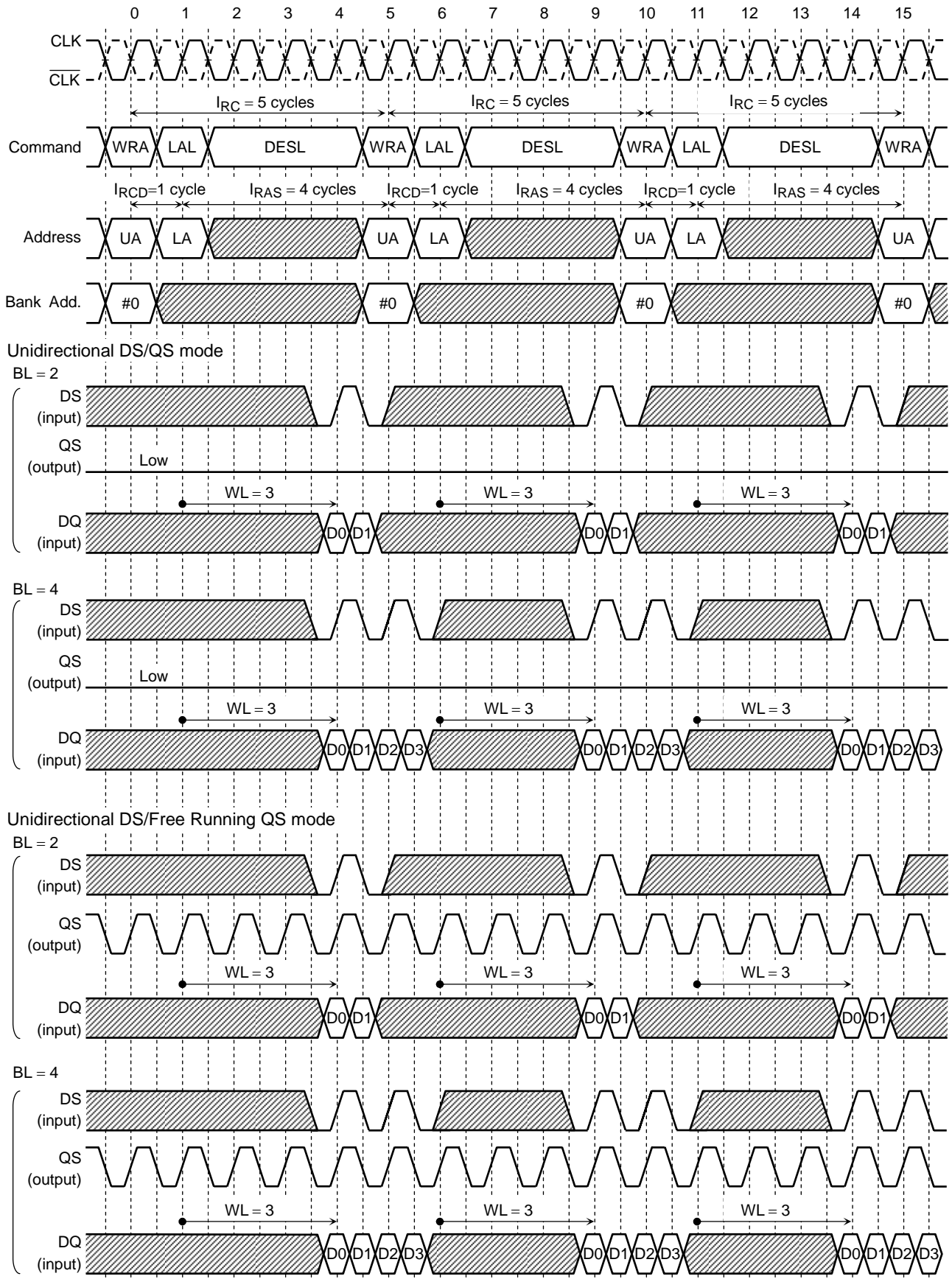

SINGLE BANK WRITE TIMING (CL = 5)

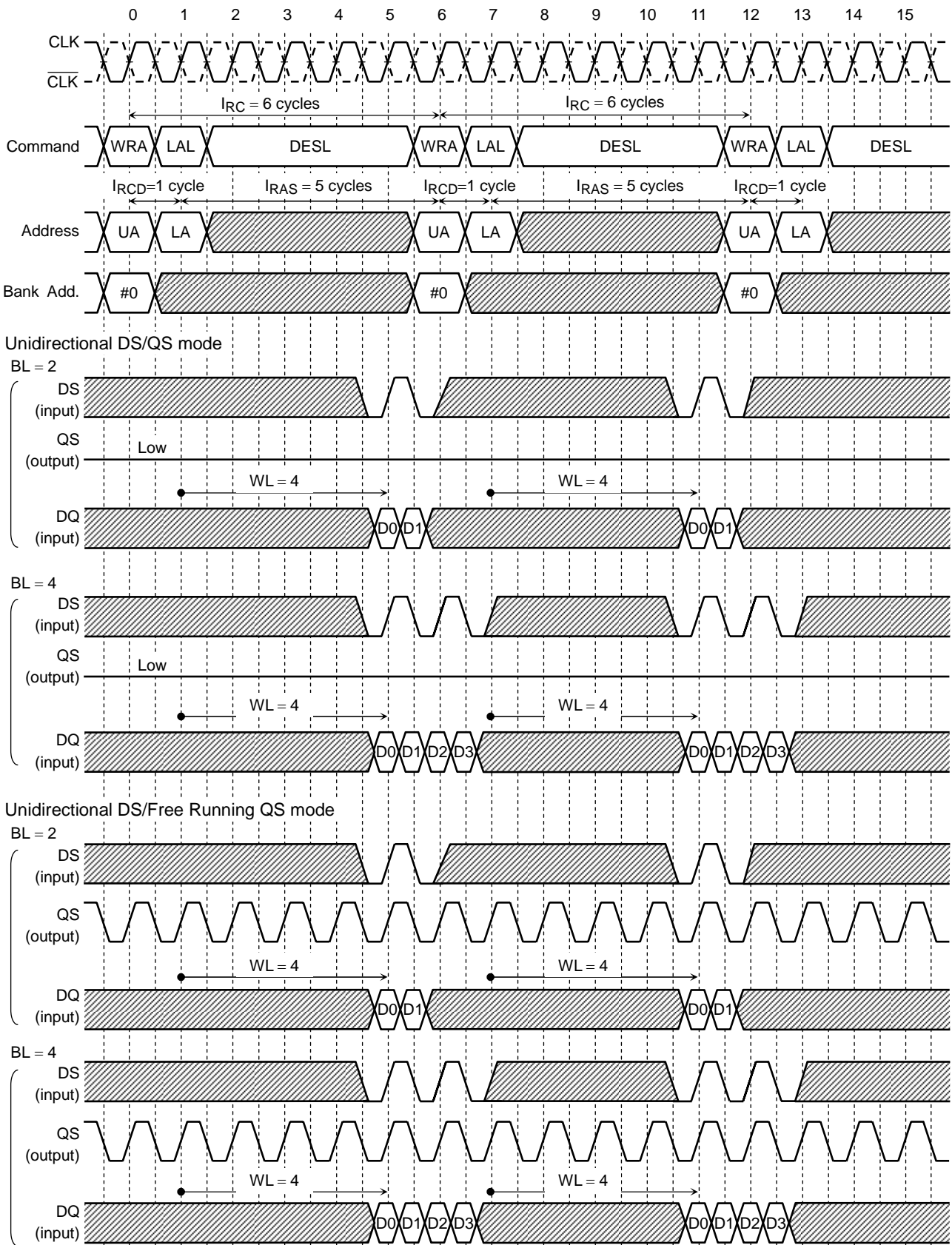

SINGLE BANK WRITE TIMING (CL = 6)

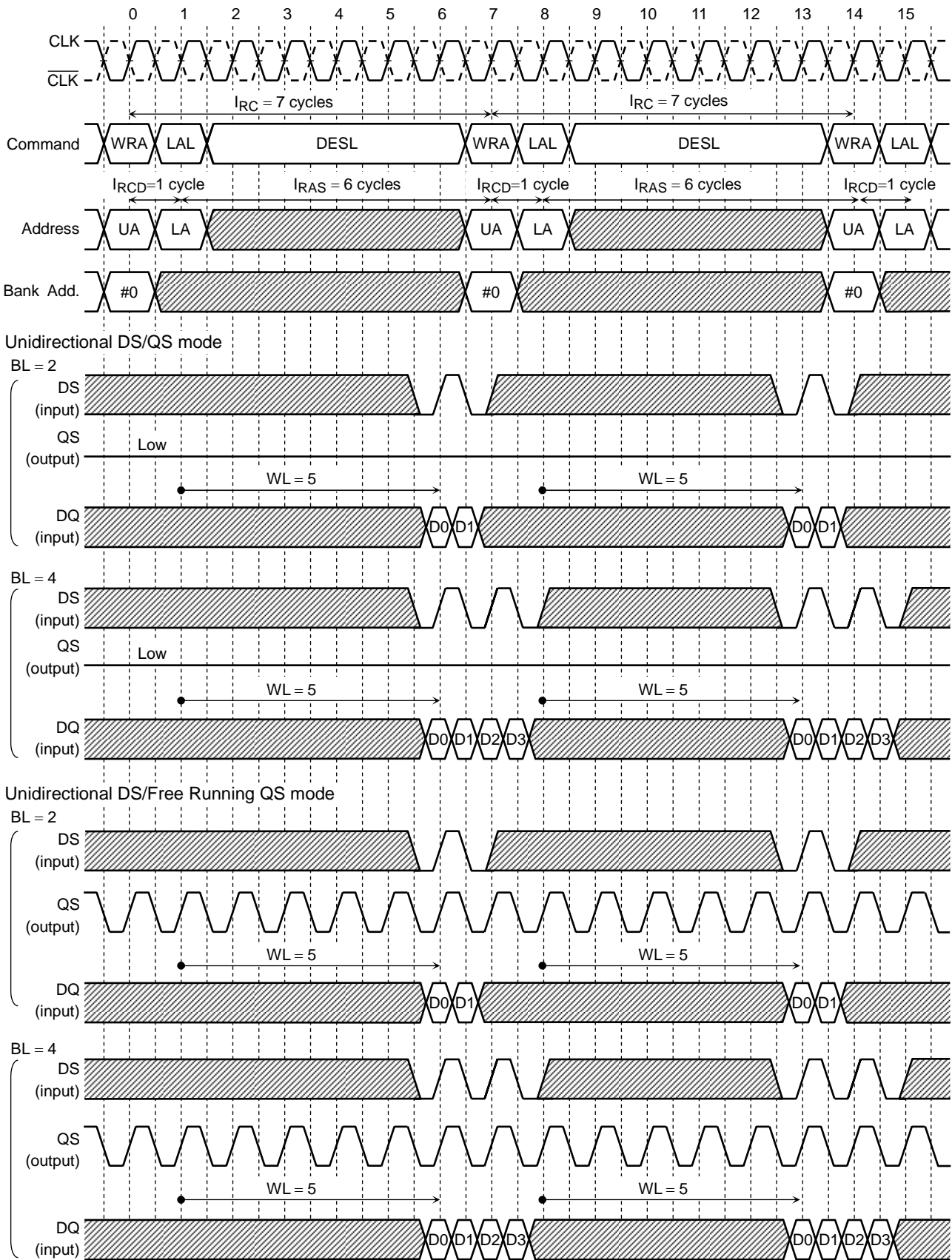

SINGLE BANK READ-WRITE TIMING (CL = 4)

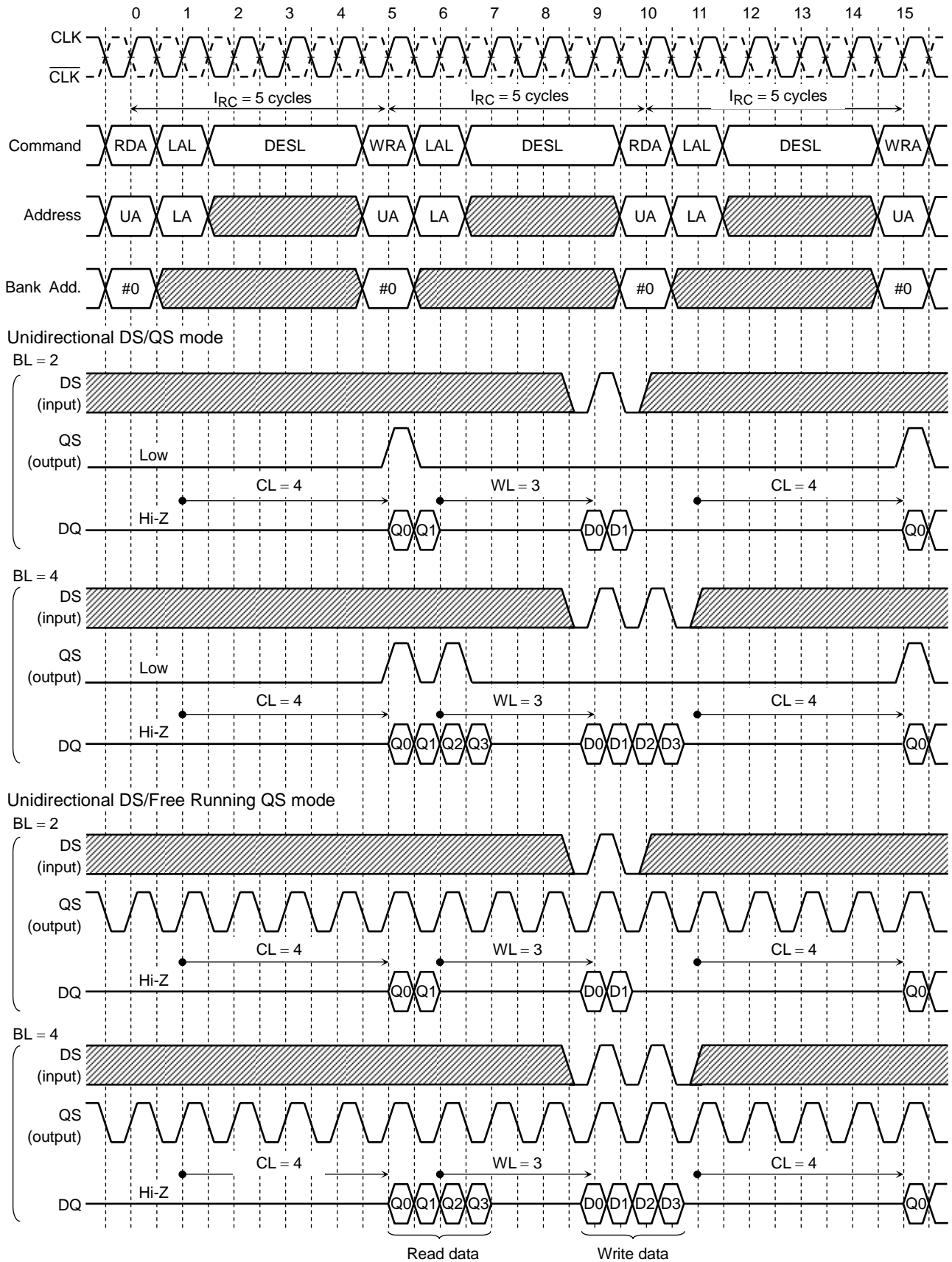

SINGLE BANK READ-WRITE TIMING (CL = 5)

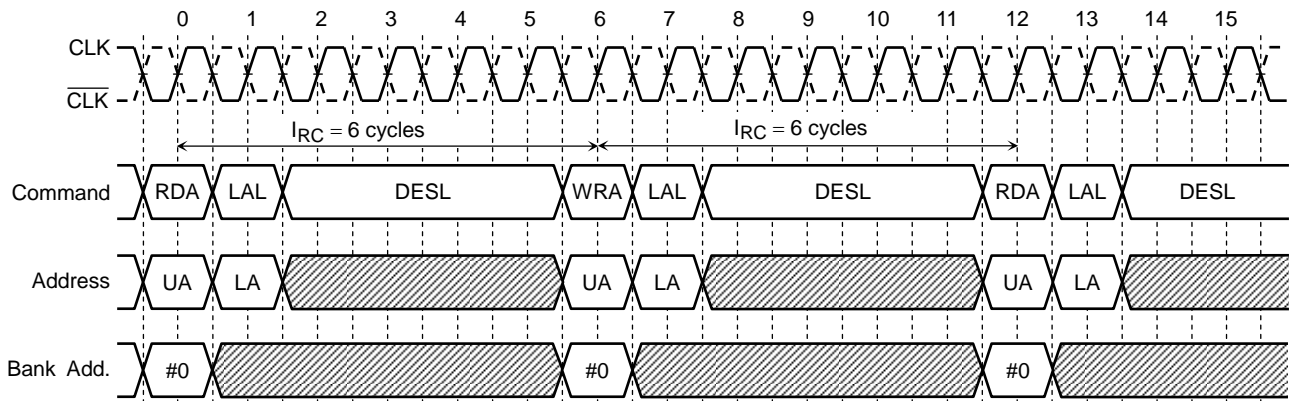

Unidirectional DS/QS mode

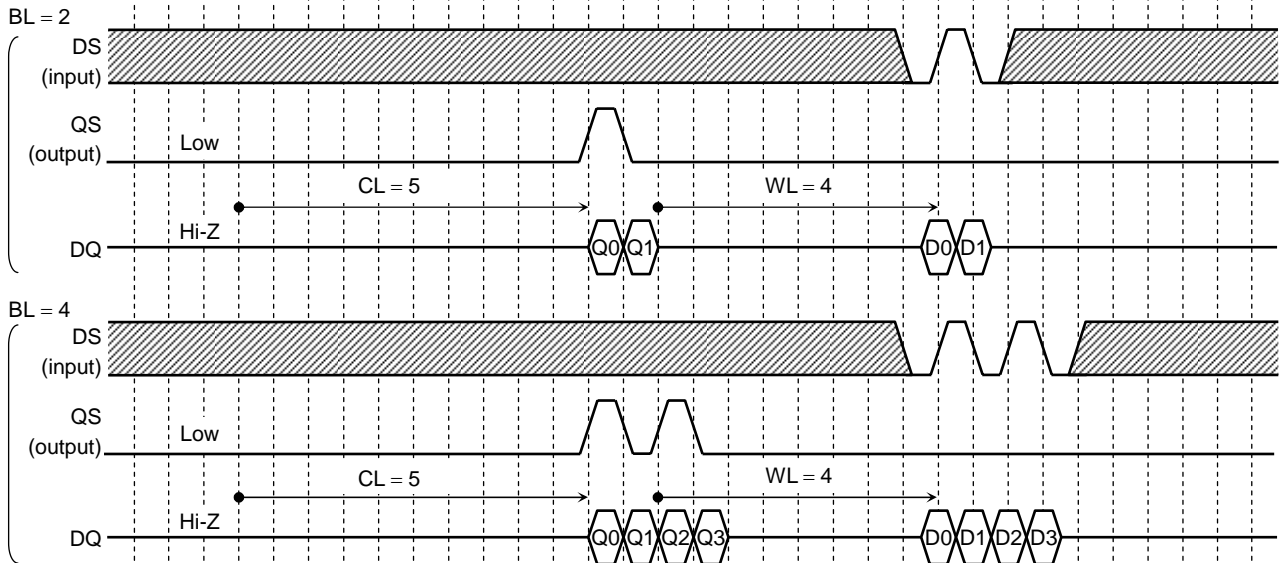

Unidirectional DS/Free Running QS mode

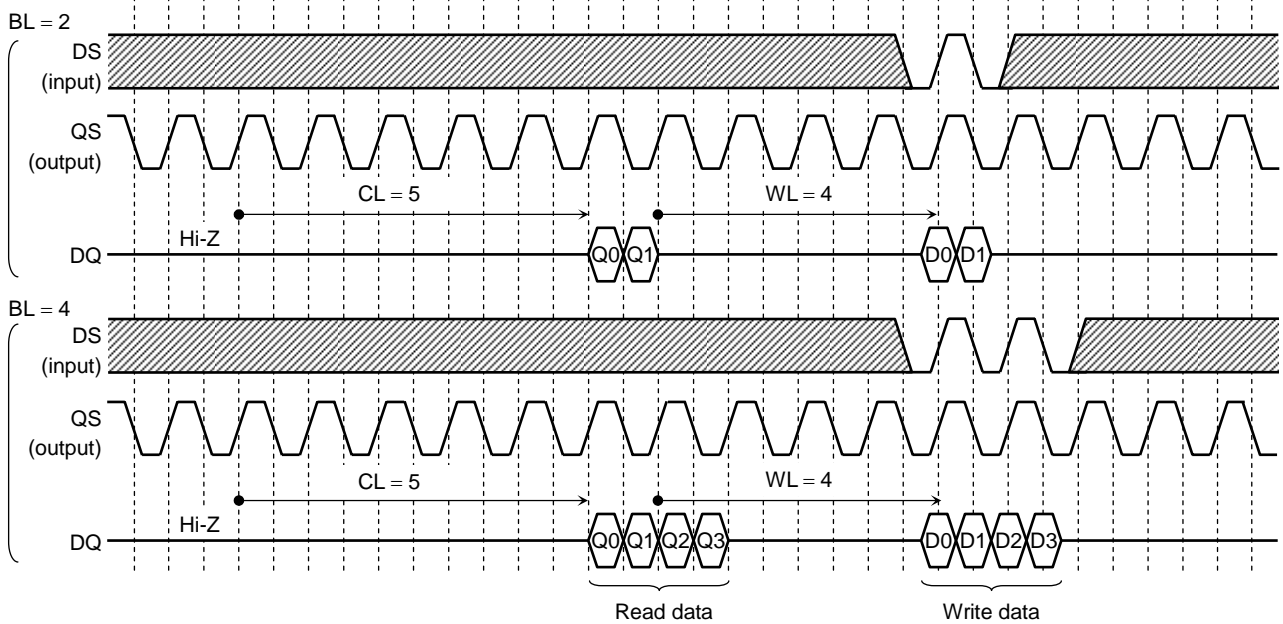

SINGLE BANK READ-WRITE TIMING (CL = 6)

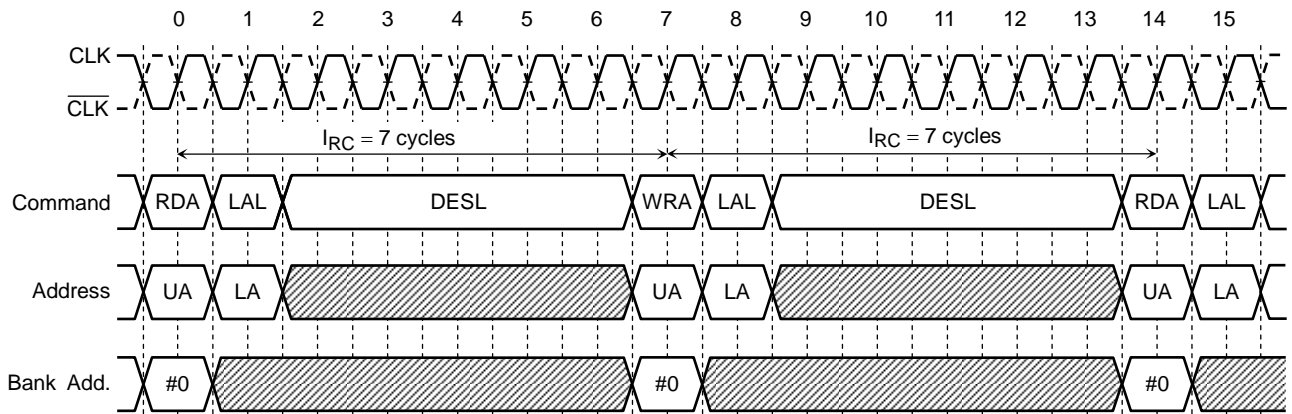

Unidirectional DS/QS mode

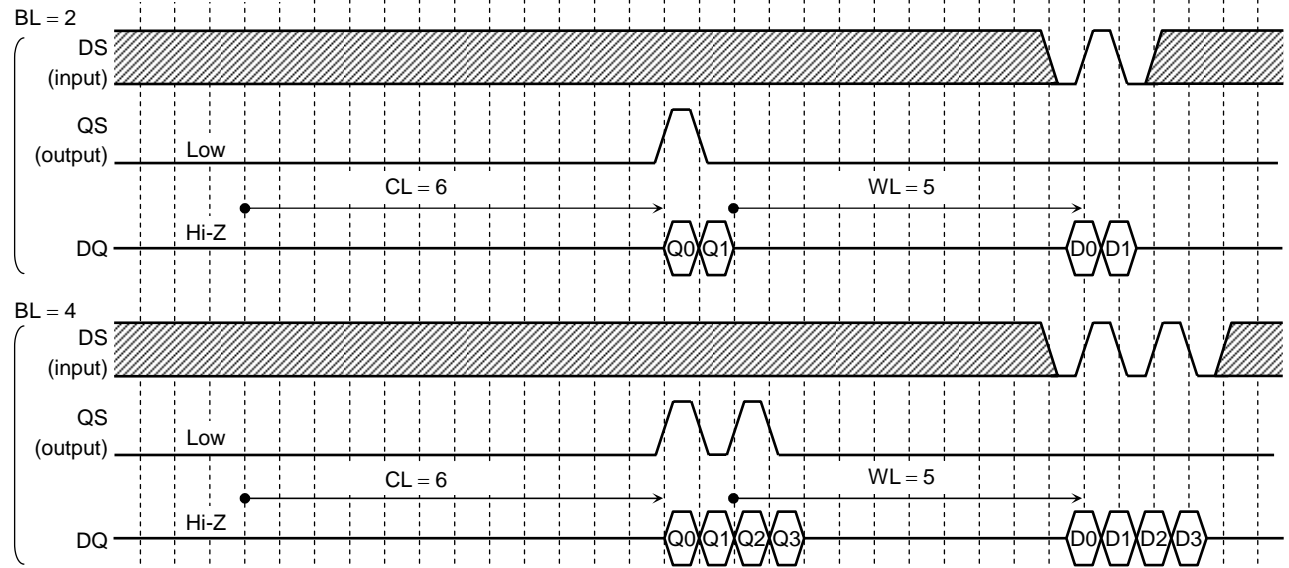

Unidirectional DS/Free Running QS mode

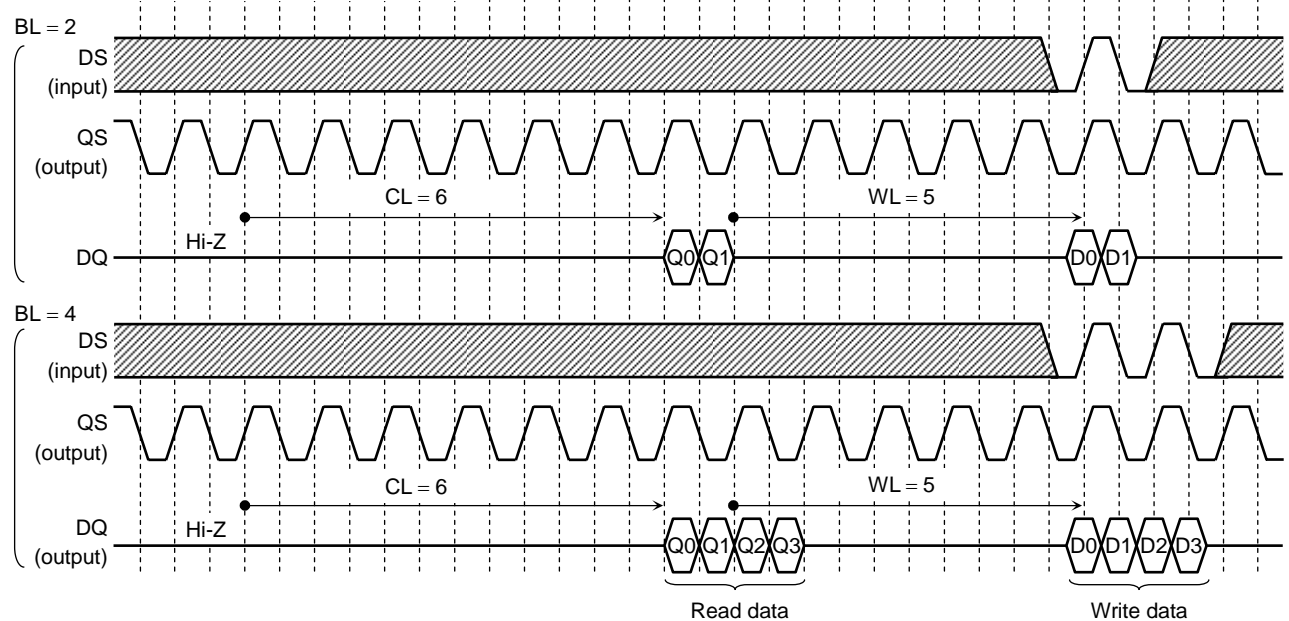

MULTIPLE BANK READ TIMING (CL = 4)

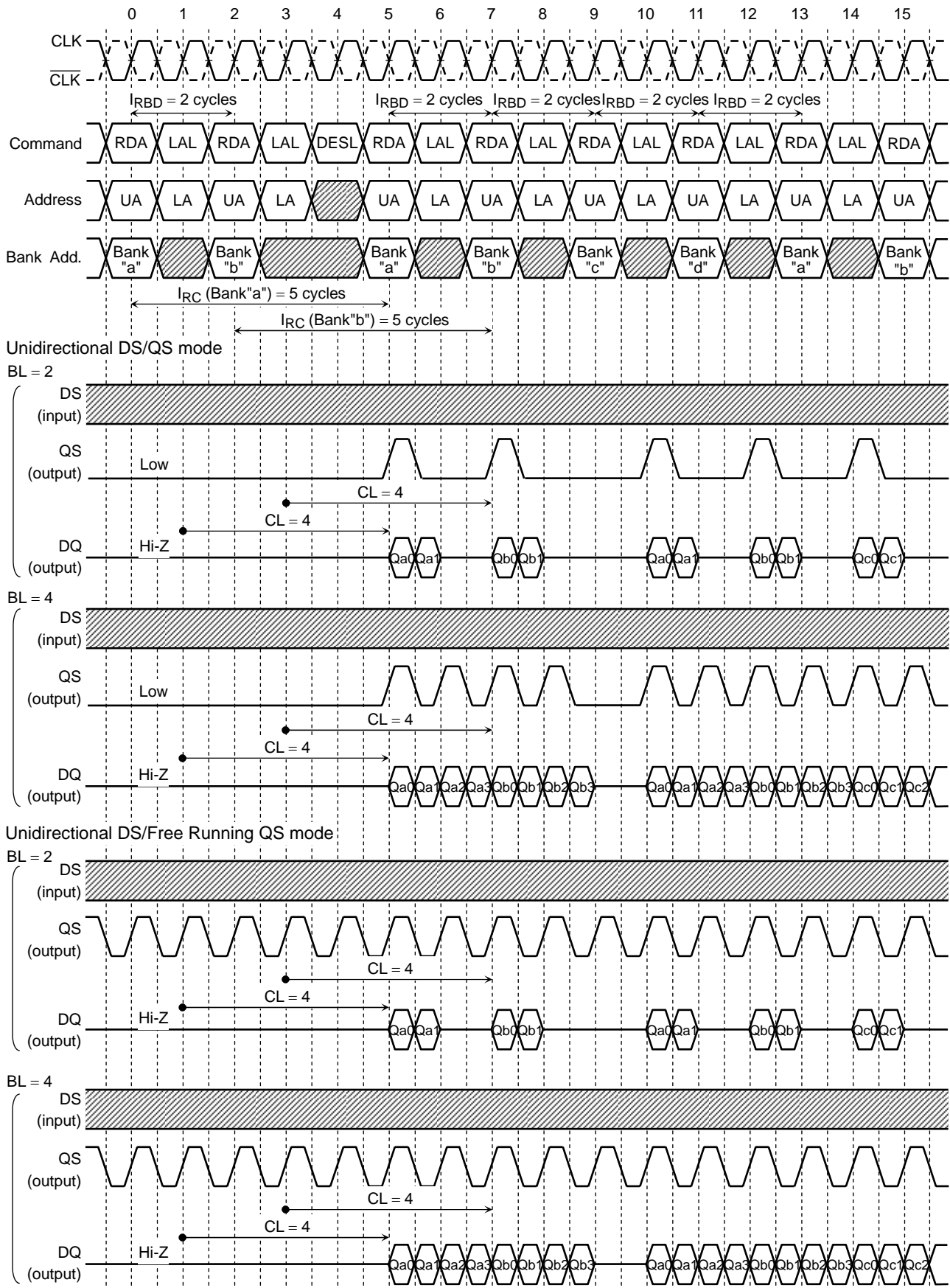

Note: IR_C to the same bank must be satisfied.

MULTIPLE BANK READ TIMING (CL = 5)

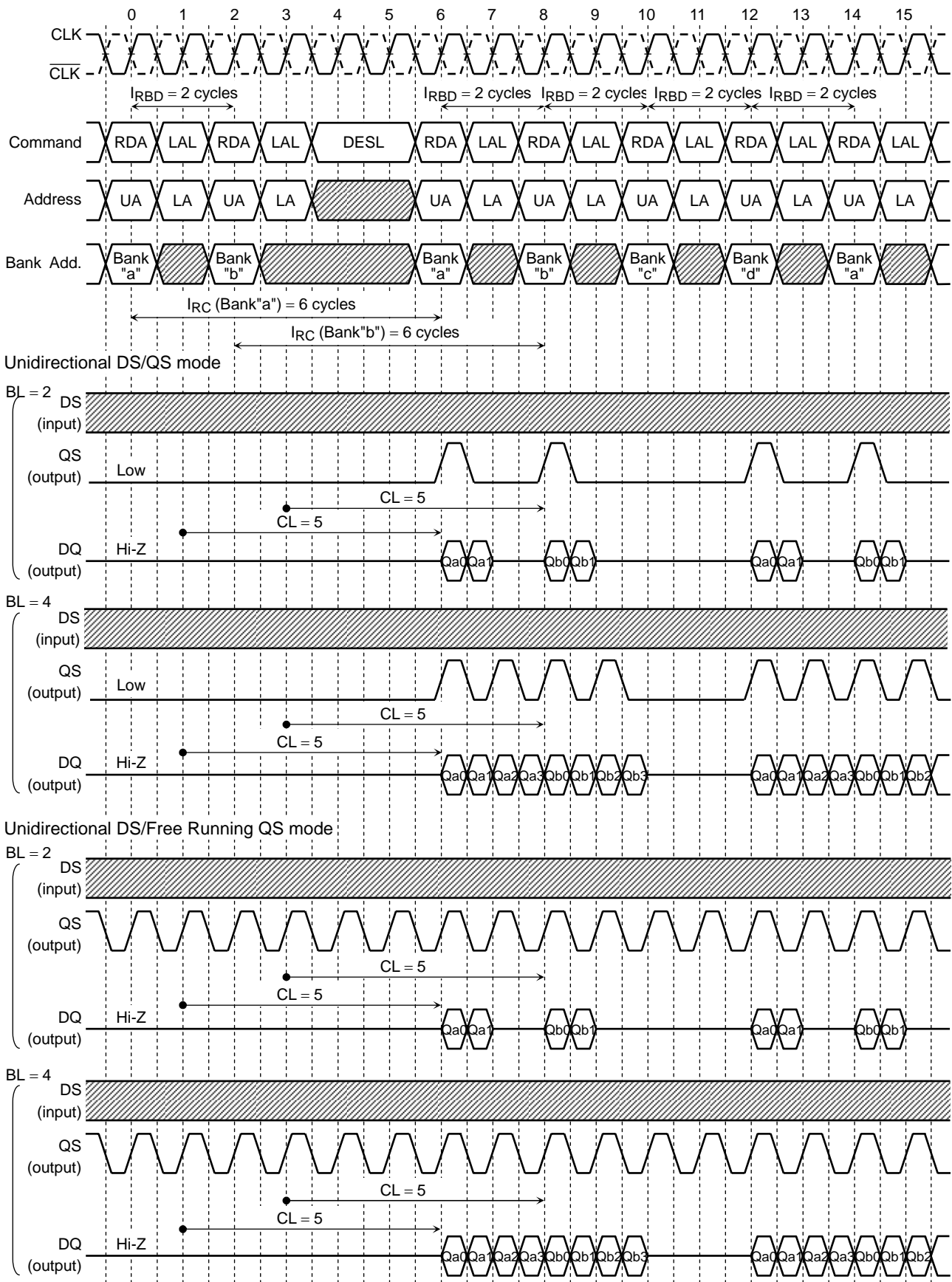

Note: I_{RC} to the same bank must be satisfied.

MULTIPLE BANK READ TIMING (CL = 6)

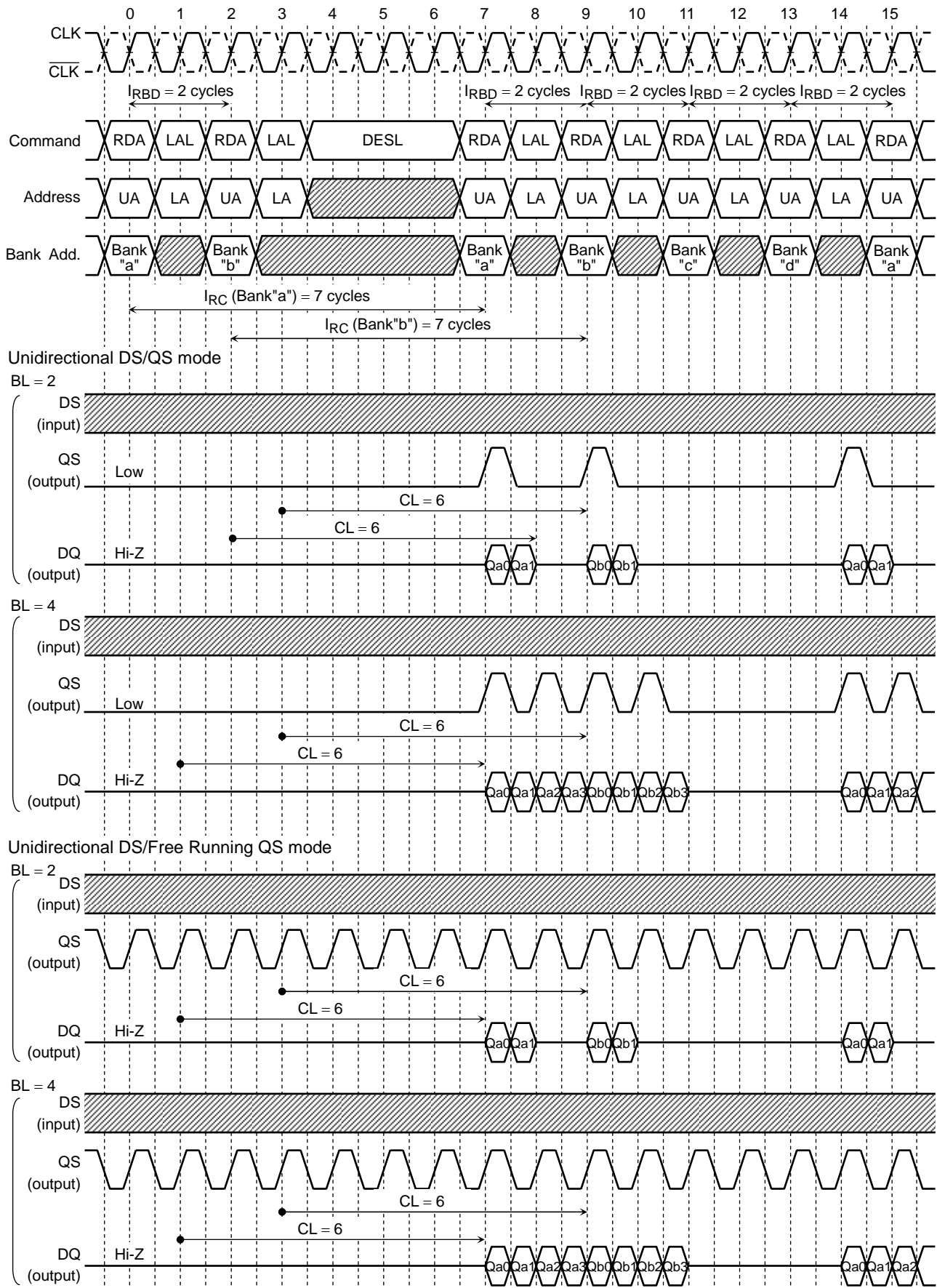

MULTIPLE BANK WRITE TIMING (CL = 4)

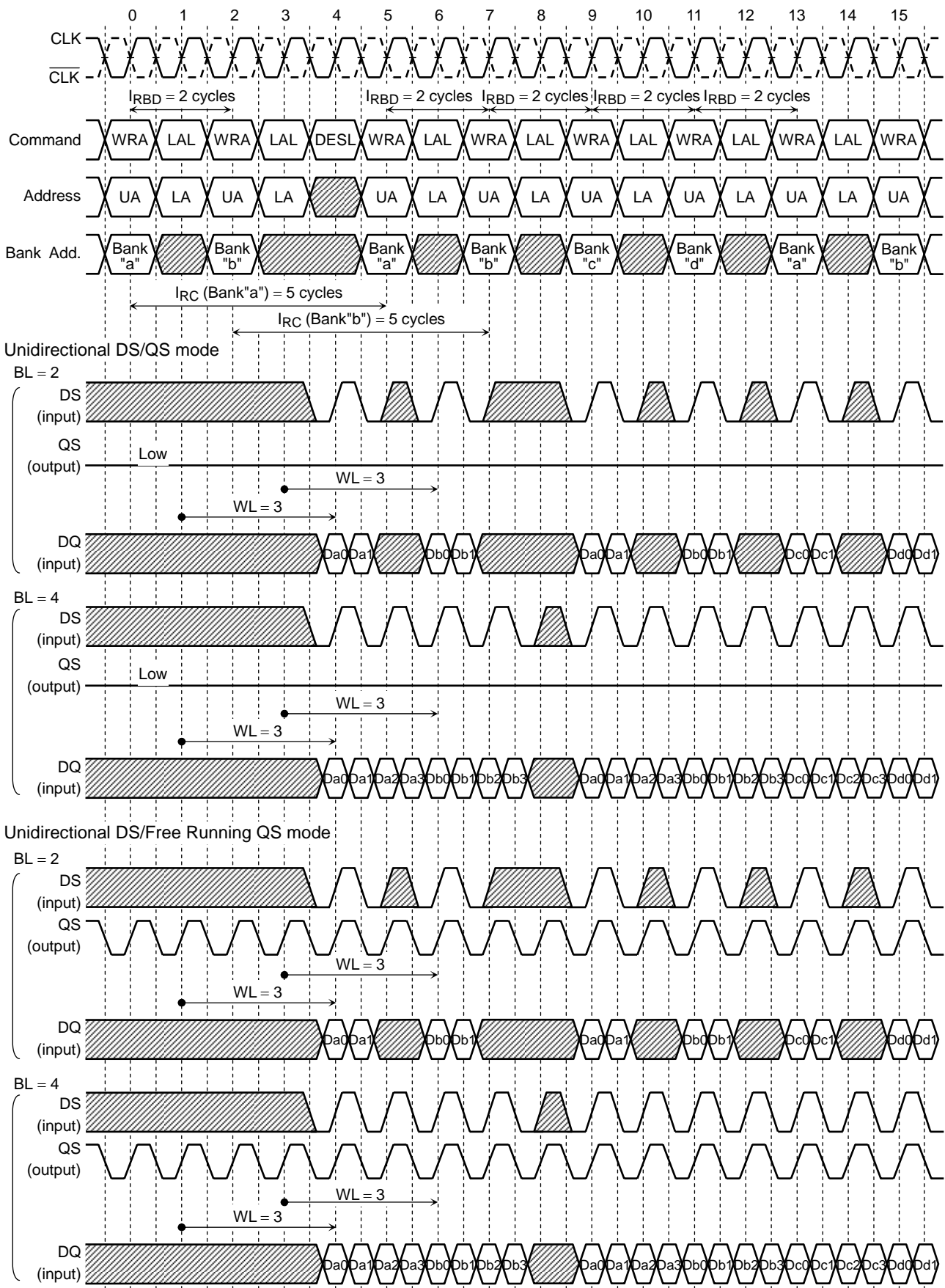

Note: t_{RC} to the same bank must be satisfied.

MULTIPLE BANK WRITE TIMING (CL = 5)

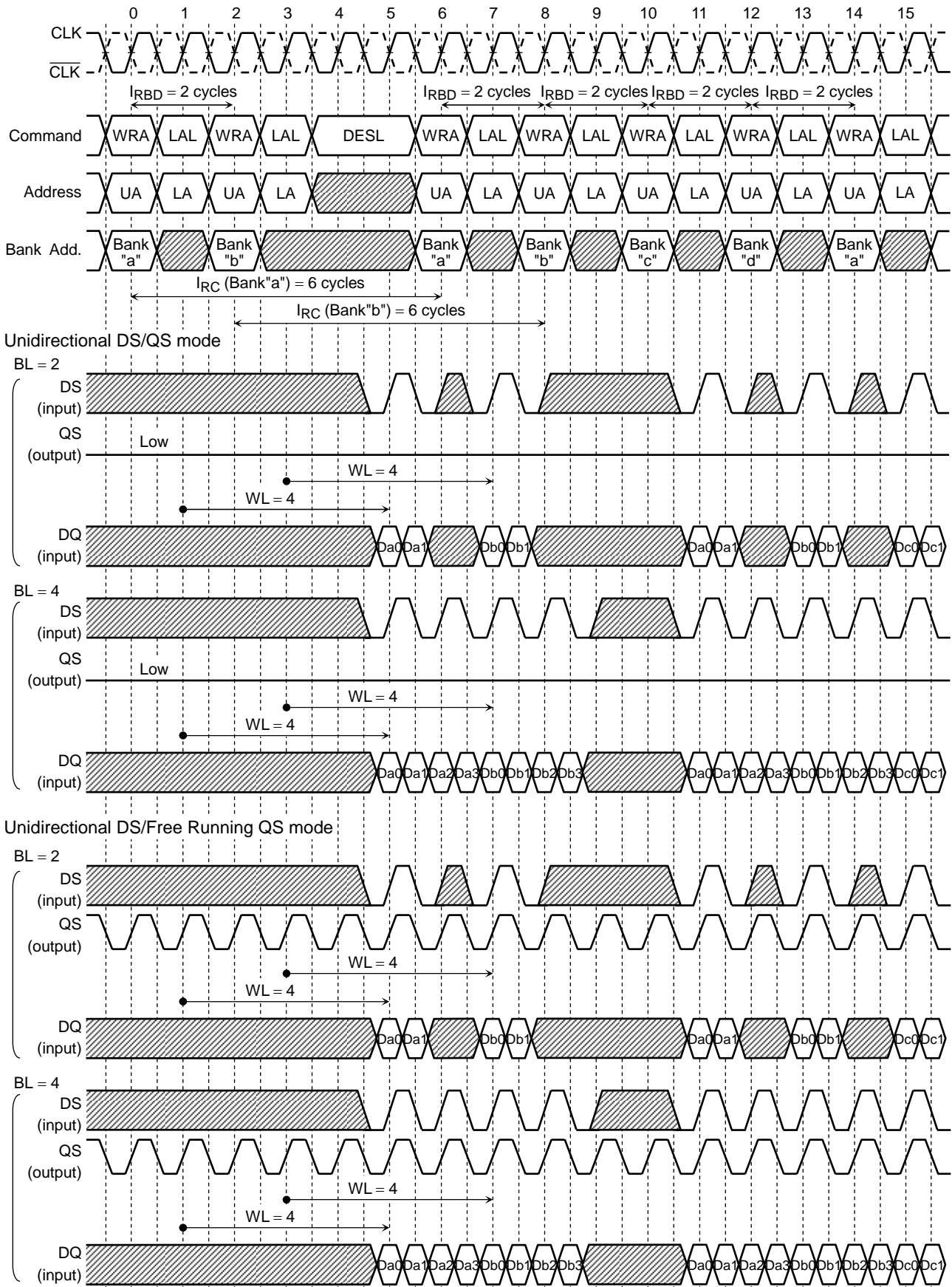

Note: IRC to the same bank must be satisfied.

MULTIPLE BANK WRITE TIMING (CL = 6)

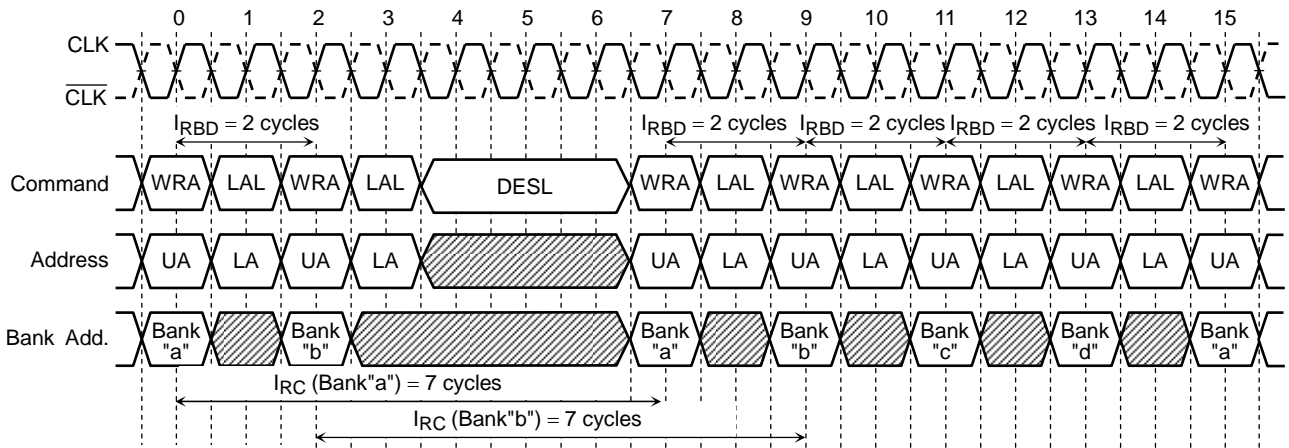

Unidirectional DS/QS mode

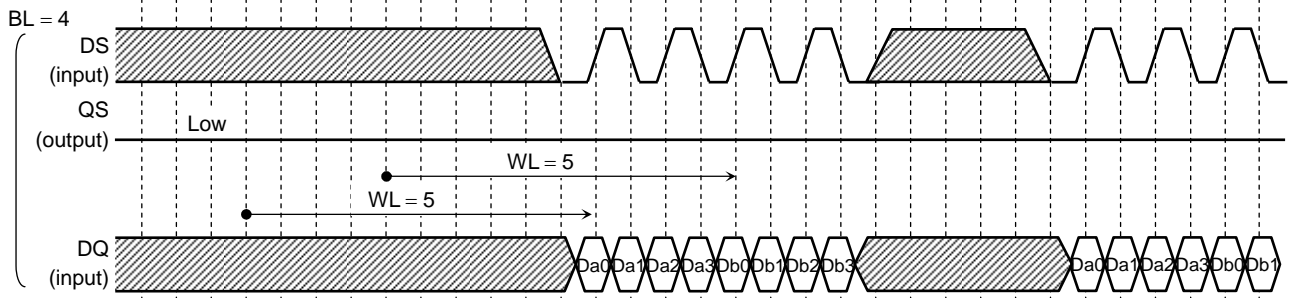
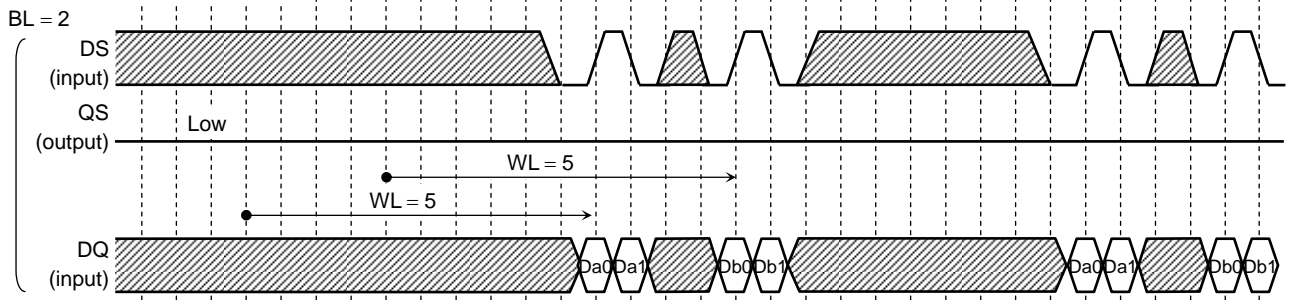

Unidirectional DS/Free Running QS mode

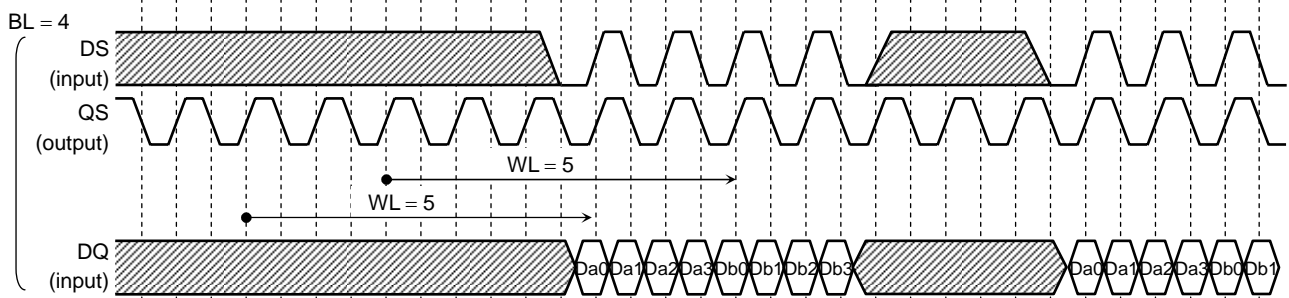
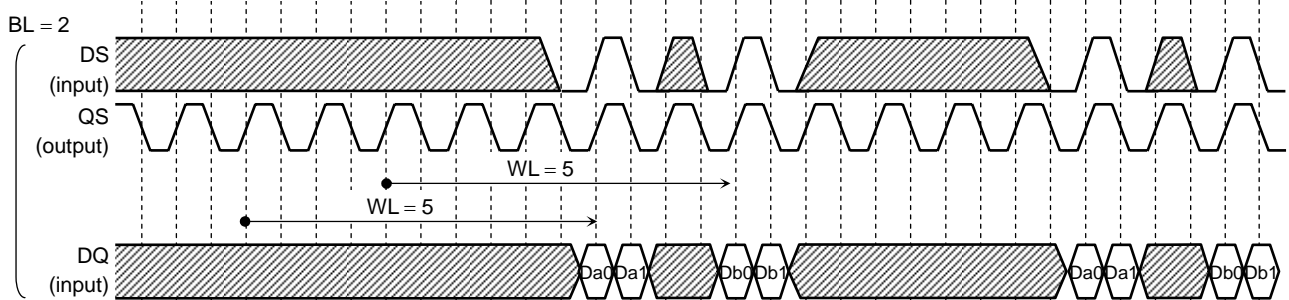

Note: I_{RC} to the same bank must be satisfied.

MULTIPLE BANK READ-WRITE TIMING (BL = 2)

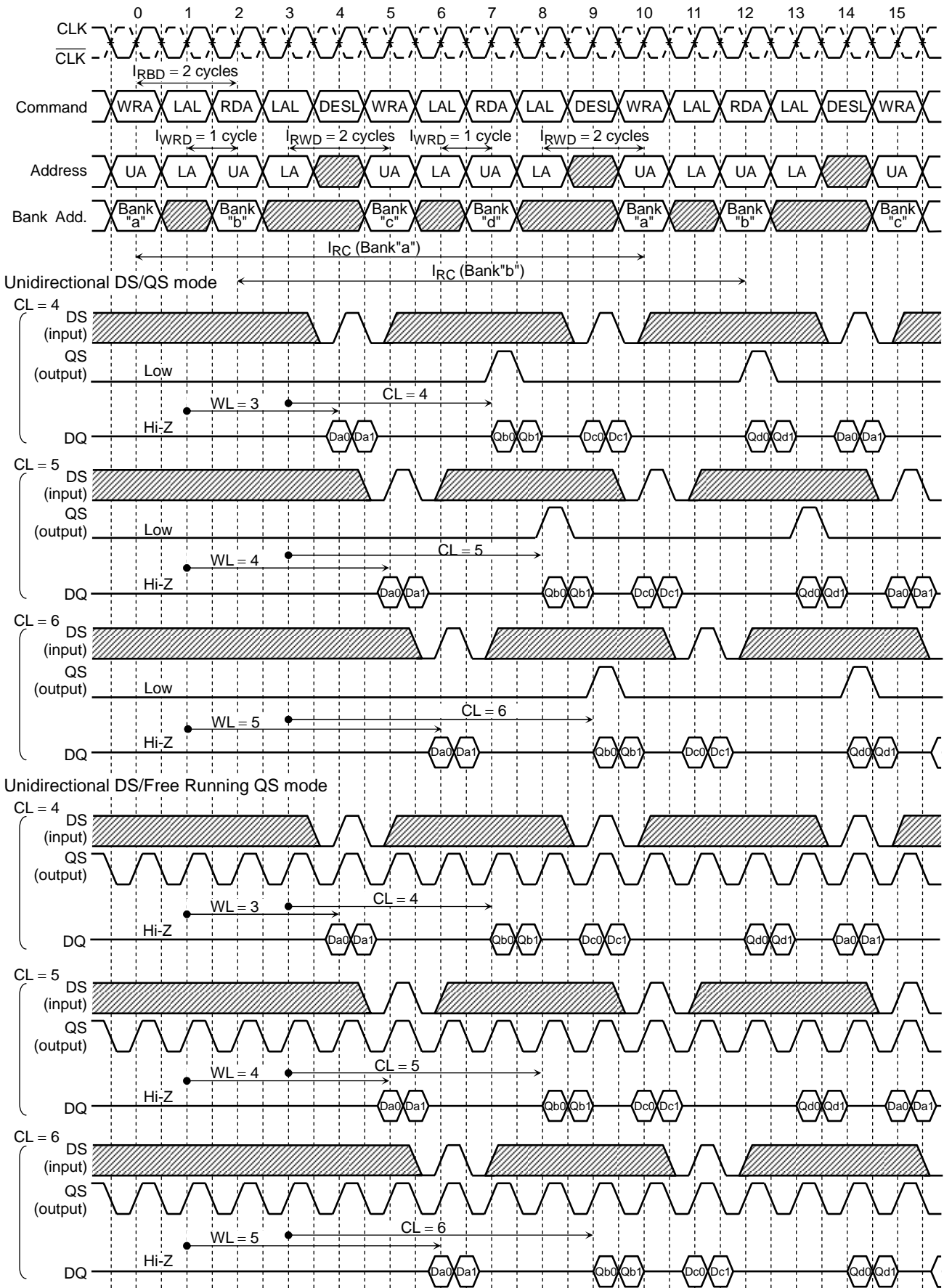

Note: I_{RC} to the same bank must be satisfied.

MULTIPLE BANK READ-WRITE TIMING (BL = 4)

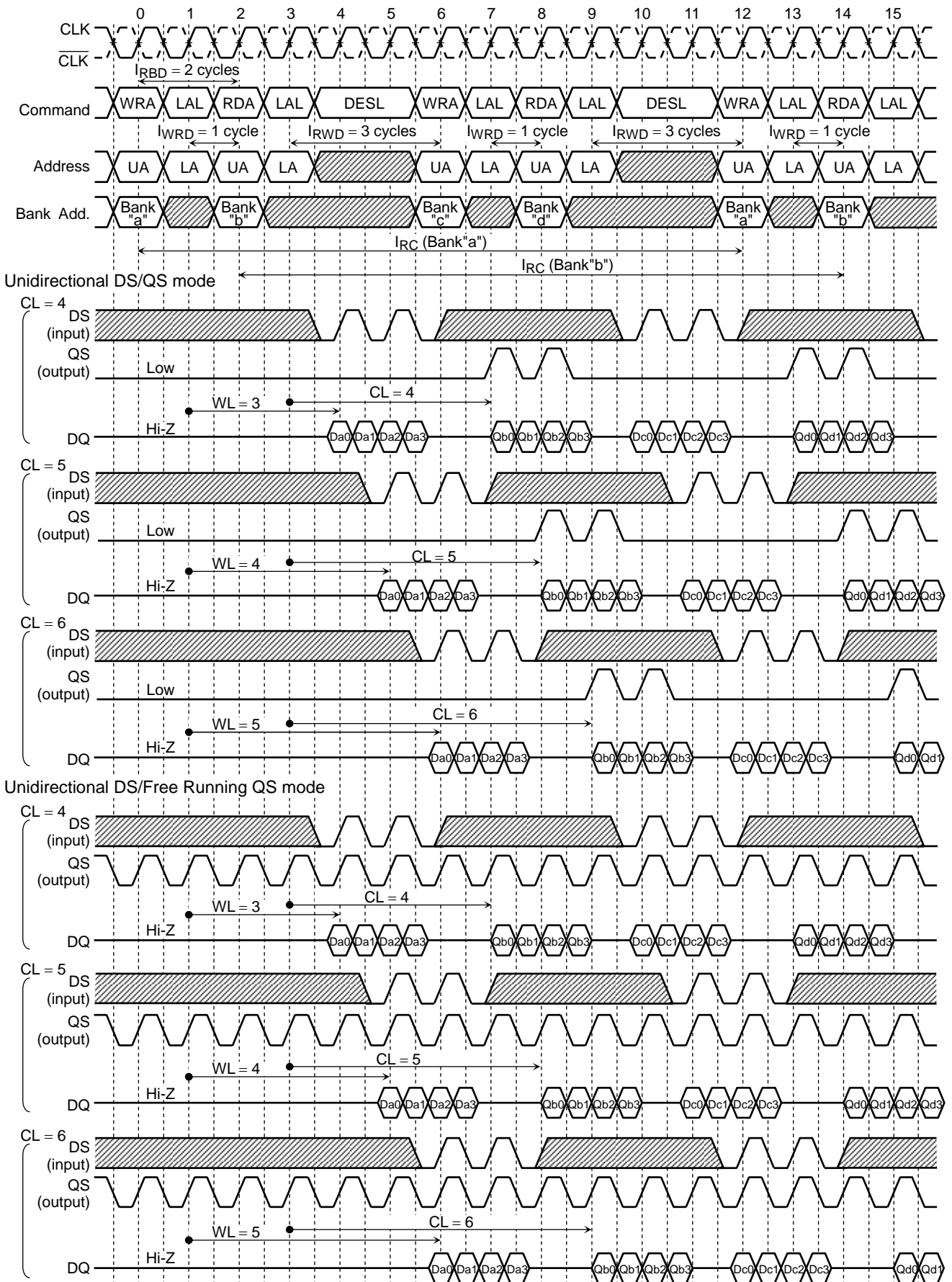

Note: I_{RC} to the same bank must be satisfied.

WRITE with VARIABLE WRITE LENGTH (VW) CONTROL (CL = 4)

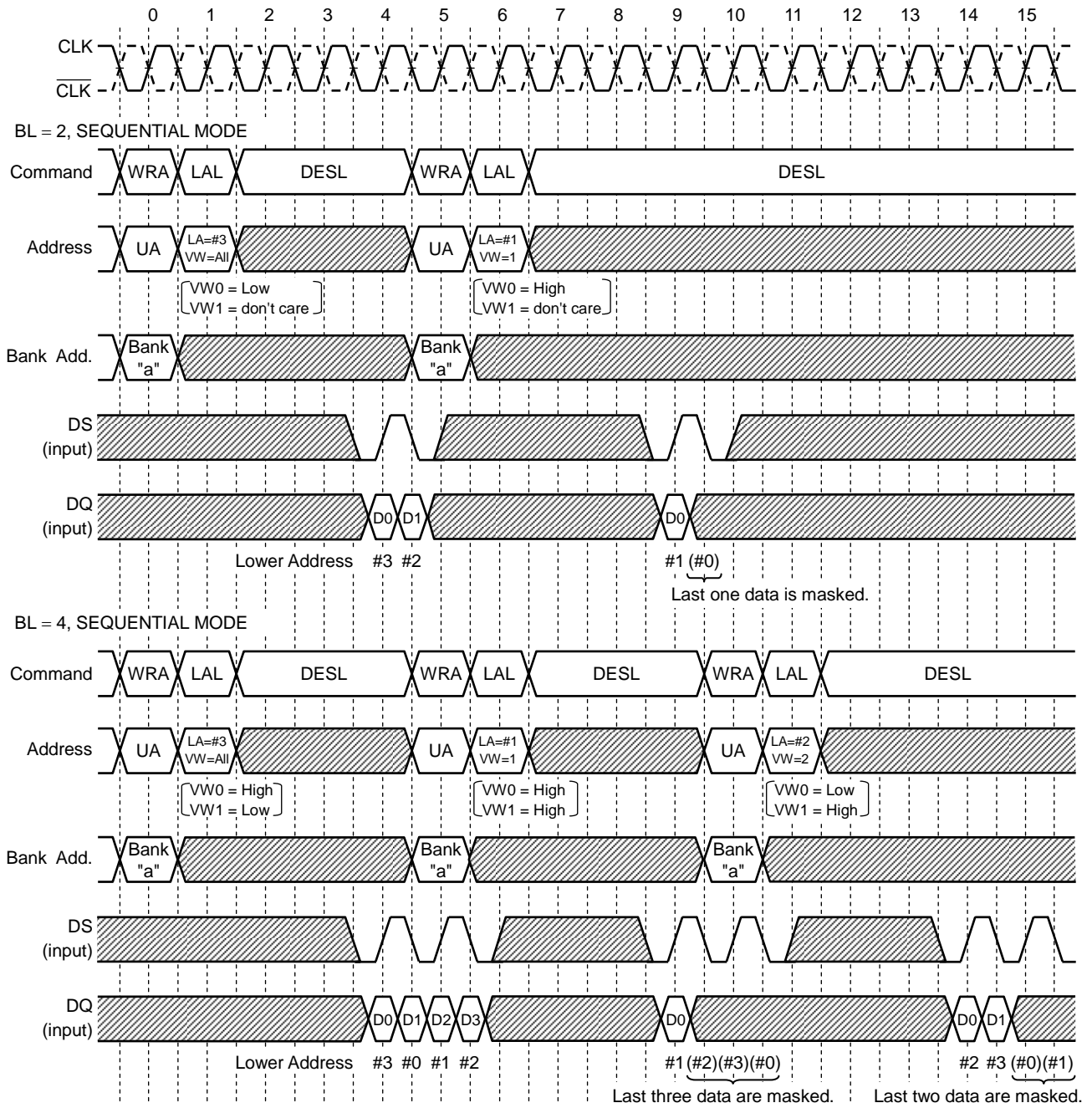

Note: DS input must be continued till end of burst count even if some of later data is masked.

POWER DOWN TIMING (CL = 4, BL = 4)

Read cycle to Power Down Mode

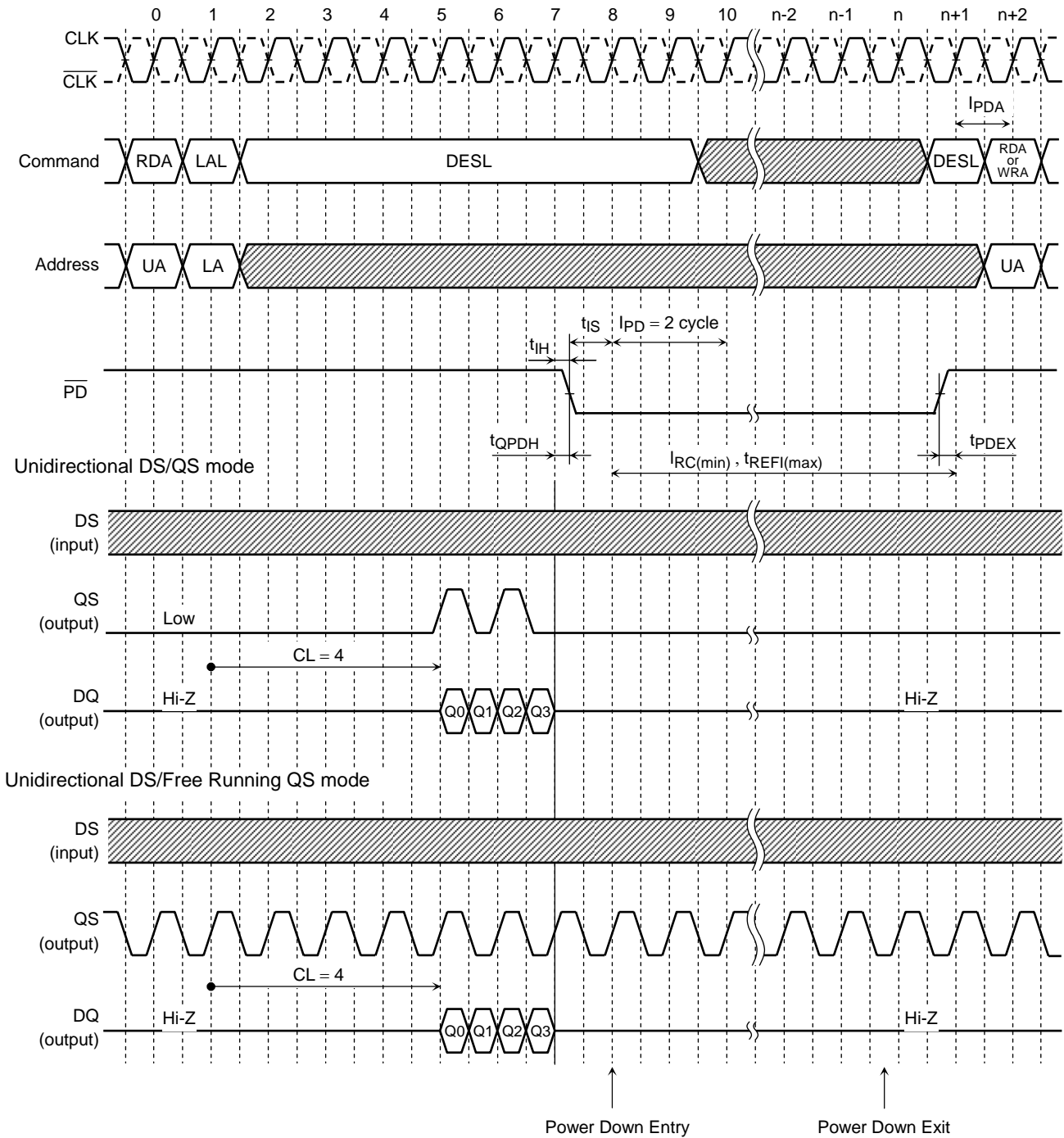

Note: \overline{PD} must be kept "High" level until end of Burst data output.
 \overline{PD} should be brought to "High" within $t_{REFI(max)}$ to maintain the data written into cell.
 In Power Down Mode, \overline{PD} "Low" and a stable clock signal must be maintained.
 When \overline{PD} is brought to "High", a valid executable command may be applied I_{PDA} cycles later.

POWER DOWN TIMING (CL = 4, BL = 4)

Write cycle to Power Down Mode

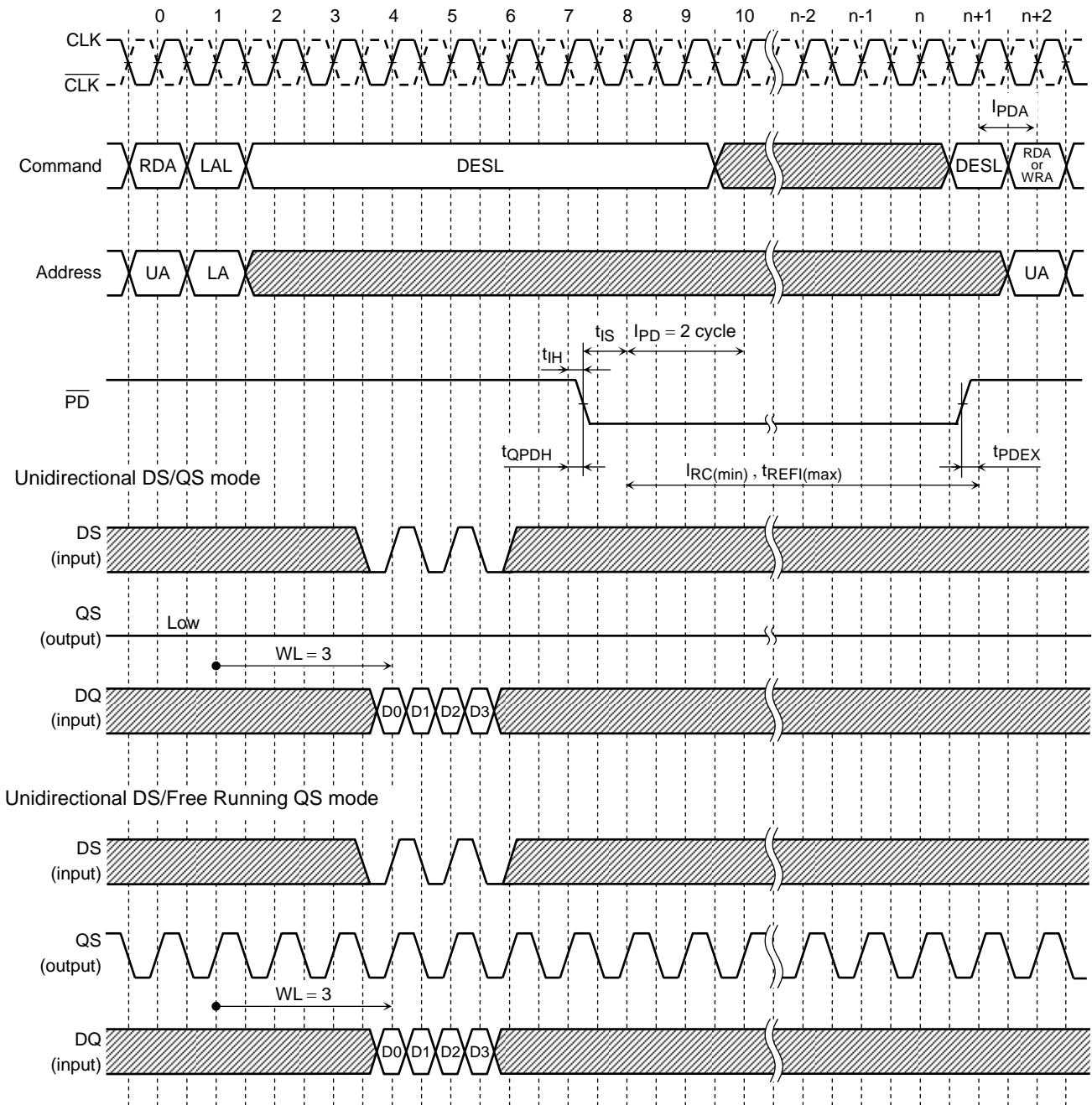

Note: \overline{PD} must be kept "High" level until WL+2 clock cycles from LAL command.
 \overline{PD} should be brought to "High" within $t_{REFI}(\max.)$ to maintain the data written into cell.
 In Power Down Mode, \overline{PD} "Low" and a stable clock signal must be maintained.
 When \overline{PD} is brought to "High", a valid executable command may be applied I_{PDA} cycles later.

MODE REGISTER SET TIMING (CL = 4, BL = 2)

From Read operation to Mode Register Set operation.

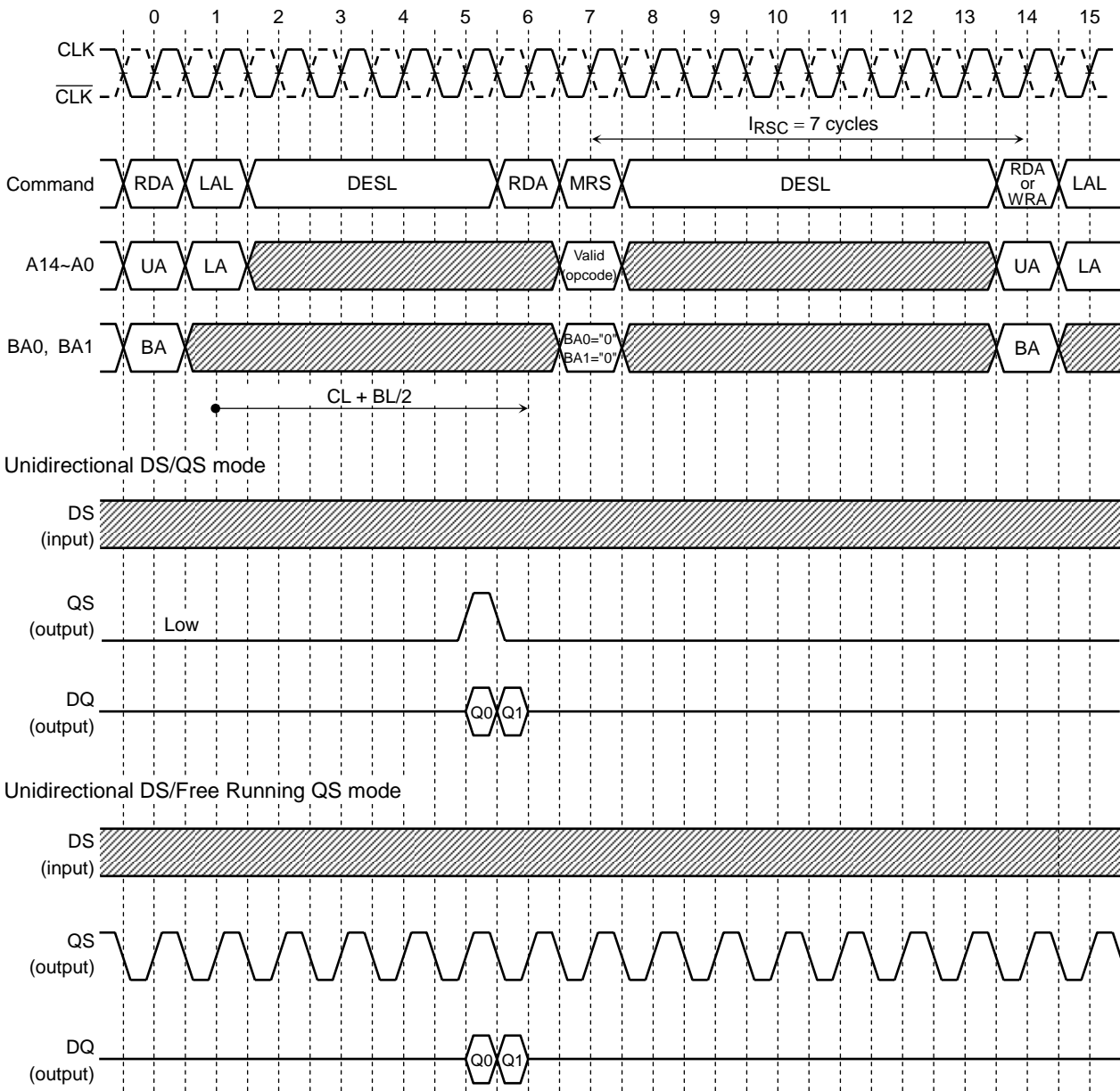

Note: Minimum delay from LAL following RDA to RDA of MRS operation is CL+BL/2.

MODE REGISTER SET TIMING (CL = 4, BL = 4)

From Write operation to Mode Register Set operation.

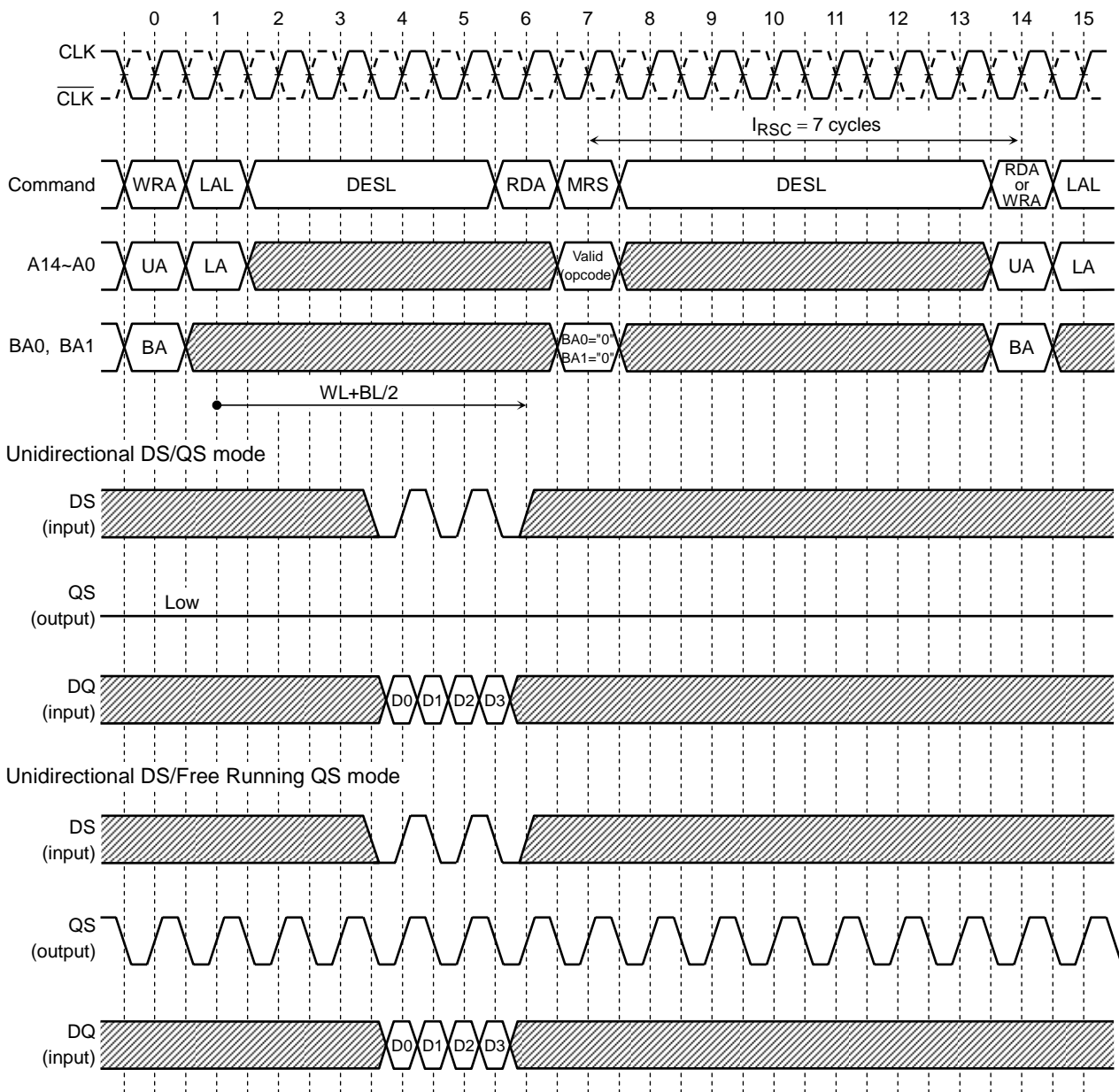

Note: Minimum delay from LAL following WRA to RDA of MRS operation is $WL + BL/2$.

EXTENDED MODE REGISTER SET TIMING (CL = 4, BL = 2)

From Read operation to Extended Mode Register Set operation.

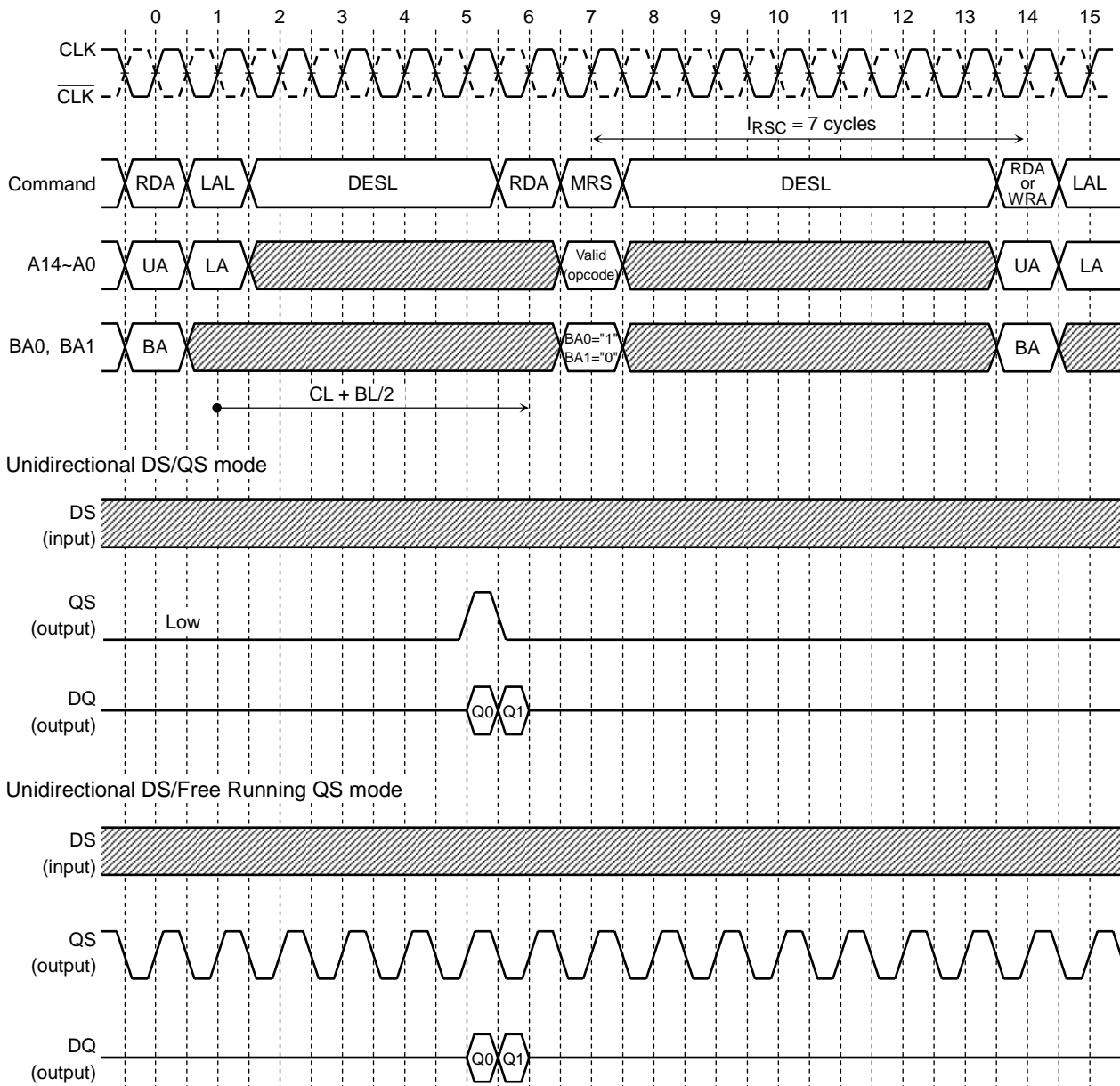

Note: Minimum delay from LAL following RDA to RDA of EMRS operation is $CL+BL/2$.
 When DQ strobe mode is changed by EMRS, QS output is invalid for I_{RSC} period.
 DLL switch in Extended Mode Register must be set to enable mode for normal operation.
 DLL lock-on time is needed after initial EMRS operation. See Power Up Sequence.

EXTENDED MODE REGISTER SET TIMING (CL = 4, BL = 4)

From Write operation to Extended Mode Register Set operation.

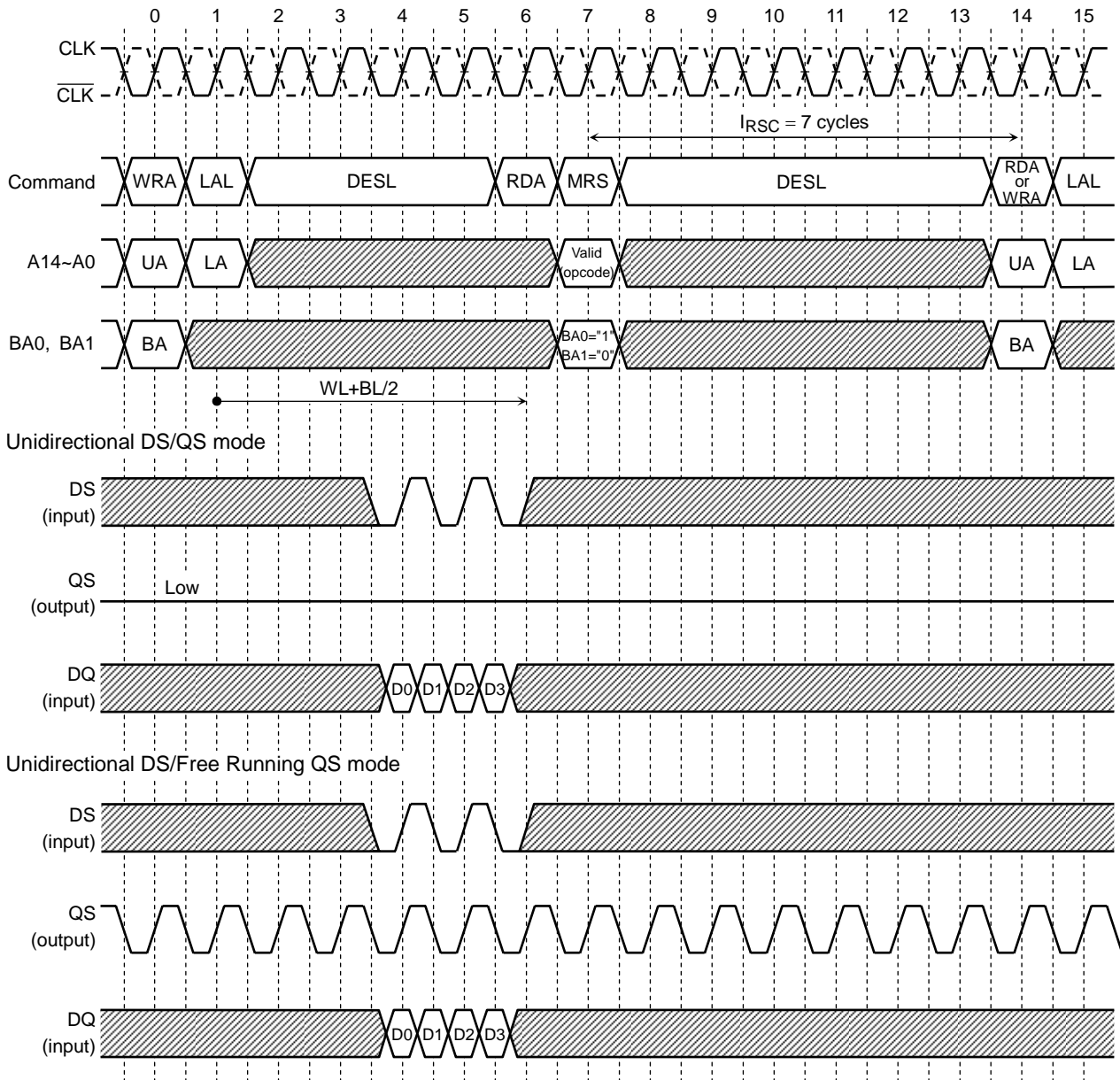

Note: When DQ strobe mode is changed by EMRS, QS output is invalid for I_{RSC} period.
 DLL switch in Extended Mode Register must be set to enable mode for normal operation.
 DLL lock-on time is needed after initial EMRS operation. See Power Up Sequence.
 Minimum delay from LAL following WRA to RDA of EMRS operation is $WL+BL/2$.

AUTO-REFRESH TIMING (CL = 4, BL = 4)

Unidirectional DS/QS mode

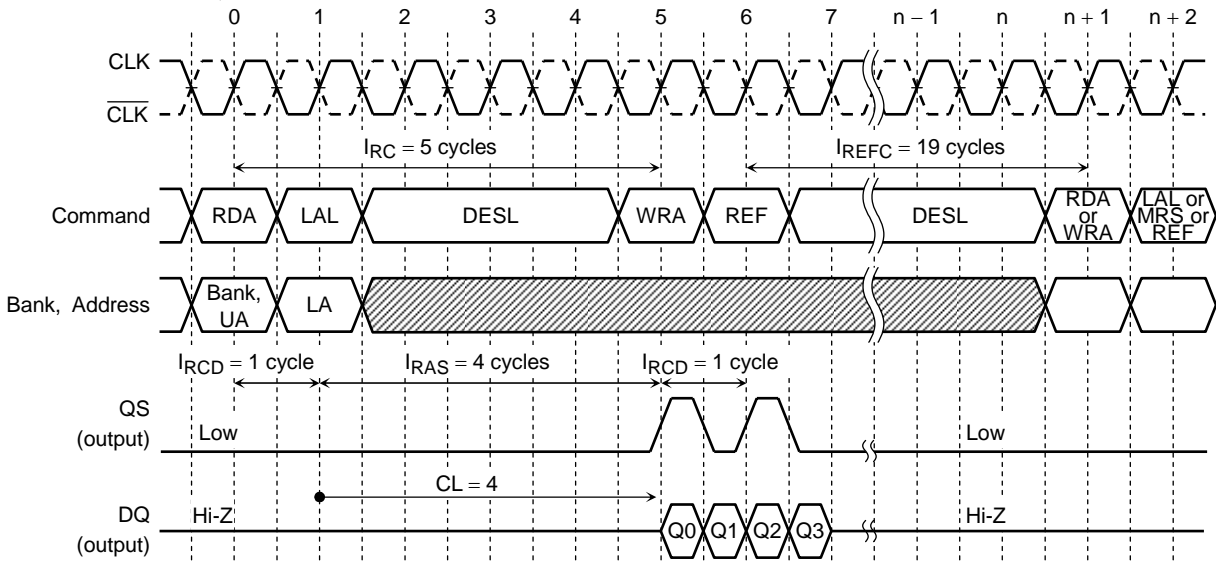

Unidirectional DS/Free Running QS mode

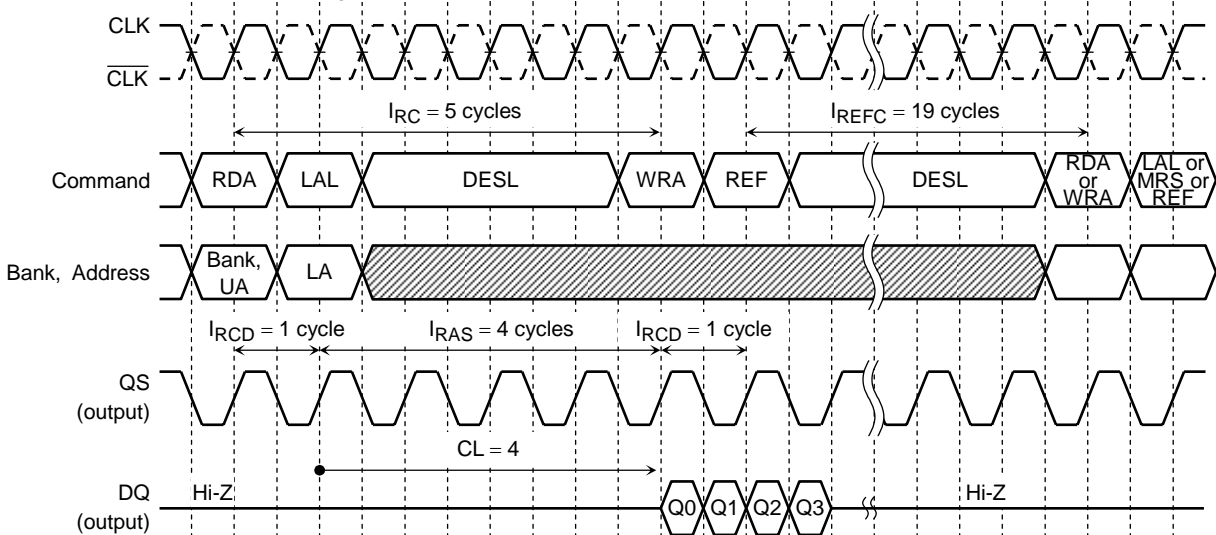

Note: In case of CL = 4, IREFC must be meet 19 clock cycles.

When the Auto-Refresh operation is performed, the synthetic average interval of Auto-Refresh command specified by tREFI must be satisfied.

tREFI is average interval time in 8 Refresh cycles that is sampled randomly.

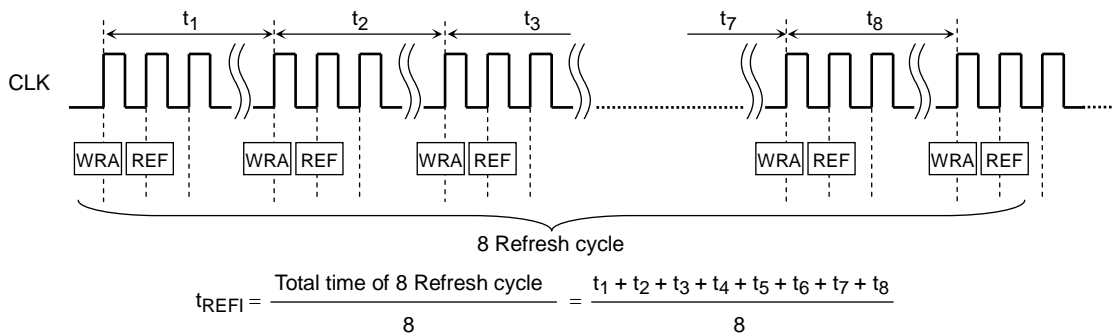

tREFI is specified to avoid partly concentrated current of Refresh operation that is activated larger area than Read / Write operation.

SELF-REFRESH ENTRY TIMING

Unidirectional DS/QS mode

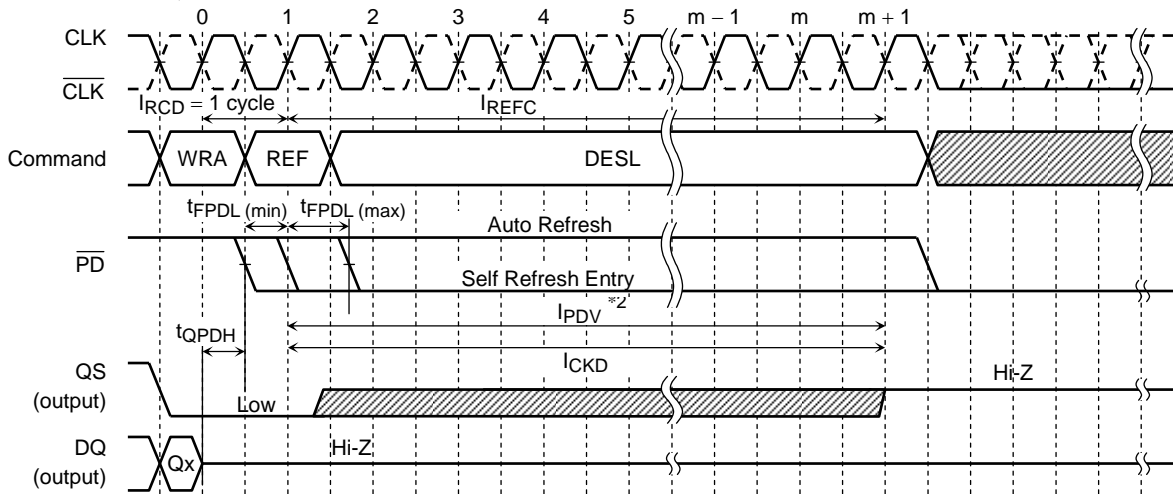

- Notes:
1. is don't care.
 2. \overline{PD} must be brought to "Low" within the timing between $t_{FPDL}(\min)$ and $t_{FPDL}(\max)$ to Self Refresh mode. When \overline{PD} is brought to "Low" after I_{PDV} , TC59LM818DMG perform Auto Refresh and enter Power down mode. In case of \overline{PD} fall between $t_{FPDL}(\max)$ and I_{PDV} , TC59LM818DMG will either entry Self-Refresh mode or Power down mode after Auto-Refresh operation. It can't be specified which mode TC59LM818DMG operates.
 3. It is desirable that clock input is continued at least I_{CKD} from REF command even though \overline{PD} is brought to "Low" for Self-Refresh Entry.
 4. In case of Self-Refresh entry after Write Operation, from the LAL command following WRA to the REF command delay time is Write latency(WL)+2 clock cycles minimum.

SELF-REFRESH EXIT TIMING

Unidirectional DS/QS mode

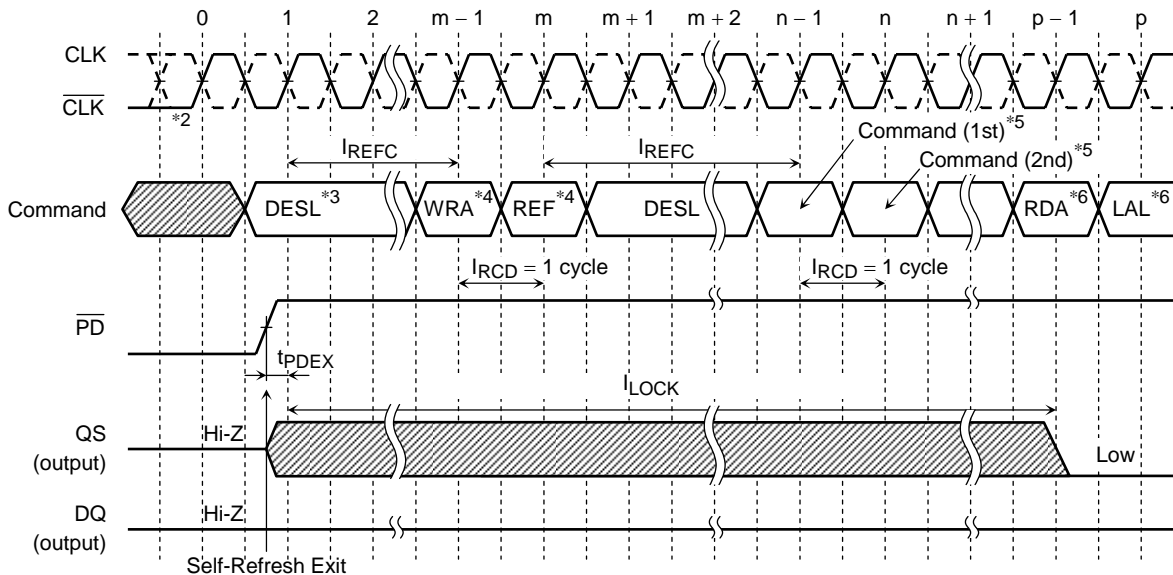

- Notes:
1. is don't care.
 2. Clock should be stable prior to \overline{PD} = "High" if clock input is suspended in Self-Refresh mode.
 3. DESL command must be asserted during I_{REFC} after \overline{PD} is brought to "High".
 4. It is desirable that one Auto-Refresh command is issued just after Self-Refresh Exit before any other operation.
 5. Any command (except Read command) can be issued after I_{REFC} .
 6. Read command (RDA + LAL) can be issued after I_{LOCK} .

SELF-REFRESH ENTRY TIMING

Unidirectional DS/Free Running QS mode

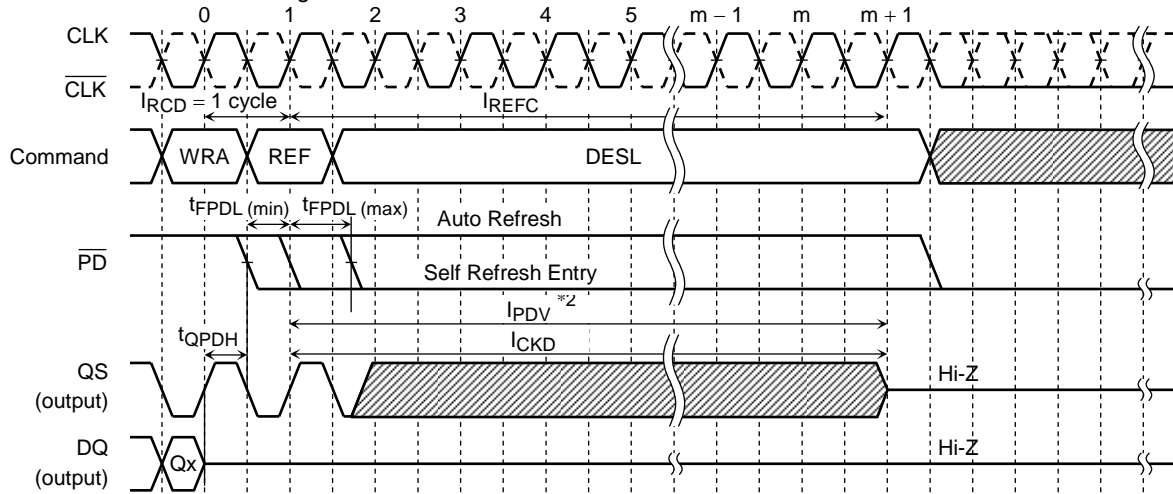

- Notes: 1. is don't care.
 2. PD must be brought to "Low" within the timing between t_{FPDL(min)} and t_{FPDL(max)} to Self Refresh mode. When PD is brought to "Low" after I_{PDV}, TC59LM818DMG perform Auto Refresh and enter Power down mode. In case of PD fall between t_{FPDL(max)} and I_{PDV}, TC59LM818DMG will either entry Self-Refresh mode or Power down mode after Auto-Refresh operation. It can't be specified which mode TC59LM818DMG operates.
 3. It is desirable that clock input is continued at least I_{CKD} from REF command even though PD is brought to "Low" for Self-Refresh Entry.
 4. In case of Self-Refresh entry after Write Operation, from the LAL command following WRA to the REF command delay time is Write latency(WL)+2 clock cycles minimum.

SELF-REFRESH EXIT TIMING

Unidirectional DS/Free Running QS mode

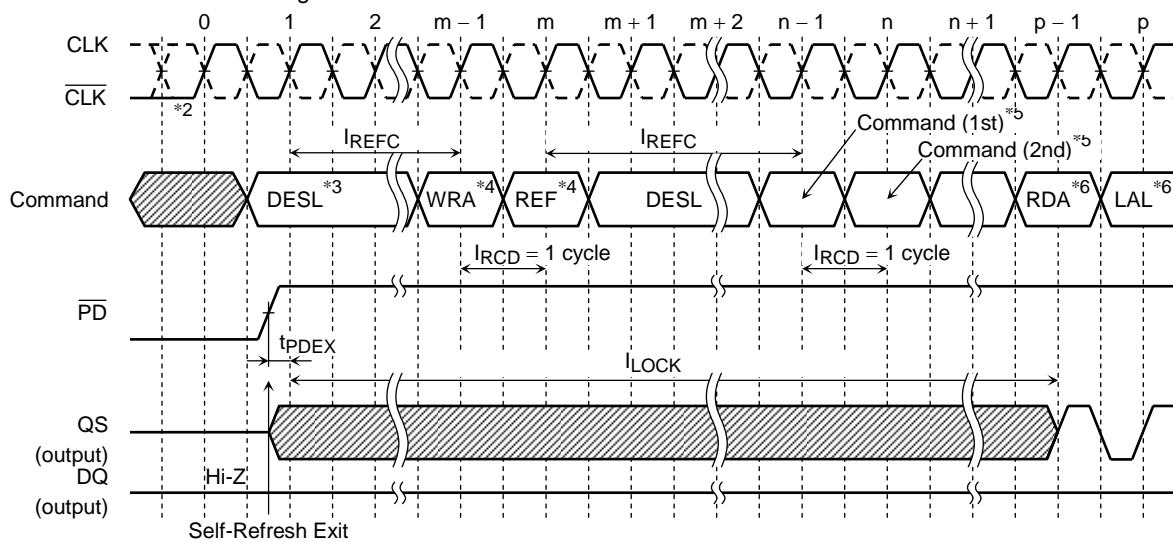

- Notes: 1. is don't care.
 2. Clock should be stable prior to PD = "High" if clock input is suspended in Self-Refresh mode.
 3. DESL command must be asserted during I_{REFC} after PD is brought to "High".
 4. It is desirable that one Auto-Refresh command is issued just after Self-Refresh Exit before any other operation.
 5. Any command (except Read command) can be issued after I_{REFC}.
 6. Read command (RDA + LAL) can be issued after I_{LOCK}.
 7. QS output is invalid until DLL lock from Self-Refresh exit.

FUNCTIONAL DESCRIPTION

Network FCRAM™

The FCRAM™ is an acronym of Fast Cycle Random Access Memory.

The Network FCRAM™ is competent to perform fast random core access, low latency and high-speed data transfer.

PIN FUNCTIONS

CLOCK INPUTS: CLK & $\overline{\text{CLK}}$

The CLK and $\overline{\text{CLK}}$ inputs are used as the reference for synchronous operation. CLK is master clock input. The $\overline{\text{CS}}$, FN and all address input signals are sampled on the crossing of the positive edge of CLK and the negative edge of $\overline{\text{CLK}}$. The QS and DQ output data are aligned to the crossing point of CLK and $\overline{\text{CLK}}$. The timing reference point for the differential clock is when the CLK and $\overline{\text{CLK}}$ signals cross during a transition.

POWER DOWN: $\overline{\text{PD}}$

The PD input controls the entry to the Power Down or Self-Refresh modes. The $\overline{\text{PD}}$ input does not have a Clock Suspend function like a CKE input of a standard SDRAMs, therefore it is illegal to bring $\overline{\text{PD}}$ pin into low state if any Read or Write operation is being performed.

CHIP SELECT & FUNCTION CONTROL: $\overline{\text{CS}}$ & FN

The $\overline{\text{CS}}$ and FN inputs are a control signal for forming the operation commands on FCRAM™. Each operation mode is decided by the combination of the two consecutive operation commands using the $\overline{\text{CS}}$ and FN inputs.

BANK ADDRESSES: BA0 & BA1

The BA0 and BA1 inputs are latched at the time of assertion of the RDA or WRA command and are selected the bank to be used for the operation. BA0 and BA1 also define which mode register is loaded during the Mode Register Set command (MRS or EMRS).

	BA0	BA1
Bank #0	0	0
Bank #1	1	0
Bank #2	0	1
Bank #3	1	1

ADDRESS INPUTS: A0~A14

Address inputs are used to access the arbitrary address of the memory cell array within each bank. The Upper Addresses with Bank addresses are latched at the RDA or WRA command and the Lower Addresses are latched at the LAL command. The A0 to A14 inputs are also used for setting the data in the Regular or Extended Mode Register set cycle.

I/O Organization	UPPER ADDRESS	LOWER ADDRESS
18 bits	A0~A14	A0~A6

DATA INPUT/OUTPUT: DQ0~DQ17

The input data of DQ0 to DQ17 are taken in synchronizing with the both edges of DS input signal. The output data of DQ0 to DQ17 are outputted synchronizing with the both edges of QS output signal.

DATA STROBE: DS, QS

Method of data strobe is chosen by Extended mode register.

(1) Unidirectional DS / QS mode

DS is input signal and QS is output signal. Both edges of DS are used to sample all DQs at Write operation. Both edges of QS are used for trigger signal of all DQs at Read operation. During Write, Auto-Refresh and NOP cycle, QS assert always "Low" level. QS is Hi-Z in Self-Refresh mode.

(2) Unidirectional DS / Free running QS mode

DS is input signal and QS is output signal. Both edge of DS are used to sample all DQs at Write operation. Both edges of QS are used for trigger signal of all DQs at Read operation. QS assert always toggle signal except Self-Refresh mode. This strobe type is easy to use for pin to pin connect application.

POWER SUPPLY: VDD, VDDQ, VSS, VSSQ

VDD and VSS are power supply pins for memory core and peripheral circuits.
VDDQ and VSSQ are power supply pins for the output buffer.

REFERENCE VOLTAGE: VREF

VREF is reference voltage for all input signals.

COMMAND FUNCTIONS and OPERATIONS

TC59LM818DMG are introduced the two consecutive command input method. Therefore, except for Power Down mode, each operation mode decided by the combination of the first command and the second command from stand-by states of the bank to be accessed.

Read Operation (1st command + 2nd command = RDA + LAL)

Issuing the RDA command with Bank Addresses and Upper Addresses to the idle bank puts the bank designated by Bank Address in a read mode. When the LAL command with Lower Addresses is issued at the next clock of the RDA command, the data is read out sequentially synchronizing with the both edges of QS output signal (Burst Read Operation). The initial valid read data appears after $\overline{\text{CAS}}$ latency from the issuing of the LAL command. The valid data is outputted for a burst length. The $\overline{\text{CAS}}$ latency, the burst length of read data and the burst type must be set in the Mode Register beforehand. The read operated bank goes back automatically to the idle state after I_{RC}.

Write Operation (1st command + 2nd command = WRA + LAL)

Issuing the WRA command with Bank Addresses and Upper Addresses to the idle bank puts the bank designated by Bank Address in a write mode. When the LAL command with Lower Addresses is issued at the next clock of the WRA command, the input data is latched sequentially synchronizing with the both edges of DS input signal (Burst Write Operation). The data and DS inputs have to be asserted in keeping with clock input after $\overline{\text{CAS}}$ latency-1 from the issuing of the LAL command. The DS has to be provided for a burst length. The $\overline{\text{CAS}}$ latency and the burst type must be set in the Mode Register beforehand. The write operated bank goes back automatically to the idle state after I_{RC}. Write Burst Length is controlled by VW0 and VW1 inputs with LAL command. See VW truth table.

Auto-Refresh Operation (1st command + 2nd command = WRA + REF)

TC59LM818DMG are required to refresh like a standard SDRAM. The Auto-Refresh operation is begun with the REF command following to the WRA command. The Auto-Refresh mode can be effective only when all banks are in the idle state. In a point to notice, the write mode started with the WRA command is canceled by the REF command having gone into the next clock of the WRA command instead of the LAL command. The minimum period between the Auto-Refresh command and the next command is specified by I_{REFC}. However, about a synthetic average interval of Auto-Refresh command, it must be careful. In case of equally distributed refresh, Auto-Refresh command has to be issued within once for every 3.9 μs by the maximum. In case of burst refresh or random distributed refresh, the average interval of eight consecutive Auto-Refresh commands has to be more than 400 ns always. In other words, the number of Auto-Refresh cycles that can be performed within 3.2 μs (8 × 400 ns) is to 8 times in the maximum.

Self-Refresh Operation (1st command + 2nd command = WRA + REF with $\overline{\text{PD}} = \text{"L"}$)

In case of Self-Refresh operation, refresh operation can be performed automatically by using an internal timer. When all banks are in the idle state and all outputs are in Hi-Z states, the TC59LM818DMG become Self-Refresh mode by issuing the Self-Refresh command. $\overline{\text{PD}}$ has to be brought to "Low" within t_{FPDL} from the REF command following to the WRA command for a Self-Refresh mode entry. In order to satisfy the refresh period, the Self-Refresh entry command should be asserted within 3.9 μs after the latest Auto-Refresh command. Once the device enters Self-Refresh mode, the DESL command must be continued for I_{REFC} period. In addition, it is desirable that clock input is kept in I_{CKD} period. The device is in Self-Refresh mode as long as $\overline{\text{PD}}$ held "Low". During Self-Refresh mode, all input and output buffers are disabled except for $\overline{\text{PD}}$, therefore the power dissipation lowers. Regarding a Self-Refresh mode exit, $\overline{\text{PD}}$ has to be changed over from "Low" to "High" along with the DESL command, and the DESL command has to be continuously issued in the number of clocks specified by I_{REFC}. The Self-Refresh exit function is asynchronous operation. It is required that one Auto-Refresh command is issued to avoid the violation of the refresh period just after I_{REFC} from Self-Refresh exit.

Power Down Mode ($\overline{\text{PD}} = \text{"L"}$)

When all banks are in the idle state and DQ outputs are in Hi-Z states, the TC59LM818DMG become Power Down Mode by asserting $\overline{\text{PD}}$ is "Low". When the device enters the Power Down Mode, all input and output buffers are disabled after specified time except for $\overline{\text{PD}}$, CLK, $\overline{\text{CLK}}$ and QS. Therefore, the power dissipation lowers. To exit the Power Down Mode, $\overline{\text{PD}}$ has to be brought to "High" and the DESL command has to be issued for I_{PDA} cycle after $\overline{\text{PD}}$ goes high. The Power Down exit function is asynchronous operation.

Mode Register Set (1st command + 2nd command = RDA + MRS)

When all banks are in the idle state, issuing the MRS command following to the RDA command can program the Mode Register. In a point to notice, the read mode started with the RDA command is canceled by the MRS command having gone into the next clock of the RDA command instead of the LAL command. The data to be set in the Mode Register is transferred using A0 to A14, BA0 and BA1 address inputs. The TC59LM818DMG have two mode registers. These are Regular and Extended Mode Register. The Regular or Extended Mode Register is chosen by BA0 and BA1 in the MRS command. The Regular Mode Register designates the operation mode for a read or write cycle. The Regular Mode Register has four function fields.

The four fields are as follows:

- (R-1) Burst Length field to set the length of burst data
- (R-2) Burst Type field to designate the lower address access sequence in a burst cycle
- (R-3) CAS Latency field to set the access time in clock cycle
- (R-4) Test Mode field to use for supplier only.

The Extended Mode Register has three function fields.

The three fields are as follows:

- (E-1) DLL Switch field to choose either DLL enable or DLL disable
- (E-2) Output Driver Impedance Control field.
- (E-3) Data Strobe Select

Once those fields in the Mode Register are set up, the register contents are maintained until the Mode Register is set up again by another MRS command or power supply is lost. The initial value of the Regular or Extended Mode Register after power-up is undefined, therefore the Mode Register Set command must be issued before proper operation.

- Regular Mode Register/Extended Mode Register change bits (BA0, BA1)
These bits are used to choose either Regular MRS or Extended MRS

BA1	BA0	Mode Register Set
0	0	Regular MRS
0	1	Extended MRS
1	×	Reserved

Regular Mode Register Fields

(R-1) Burst Length field (A2 to A0)

This field specifies the data length for column access using the A2 to A0 pins and sets the Burst Length to be 2 or 4 words.

A2	A1	A0	BURST LENGTH
0	0	0	Reserved
0	0	1	2 words
0	1	0	4 words
0	1	1	Reserved
1	×	×	Reserved

(R-2) Burst Type field (A3)

The Burst Type can be chosen Interleave mode or Sequential mode. When the A3 bit is “0”, Sequential mode is selected. When the A3 bit is “1”, Interleave mode is selected. Both burst types support burst length of 2 and 4 words.

A3	BURST TYPE
0	Sequential
1	Interleave

• Addressing sequence of Sequential mode (A3)

A column access is started from the inputted lower address and is performed by incrementing the lower address input to the device.

$\overline{\text{CAS}}$ Latency = 4 (Free Running QS mode)

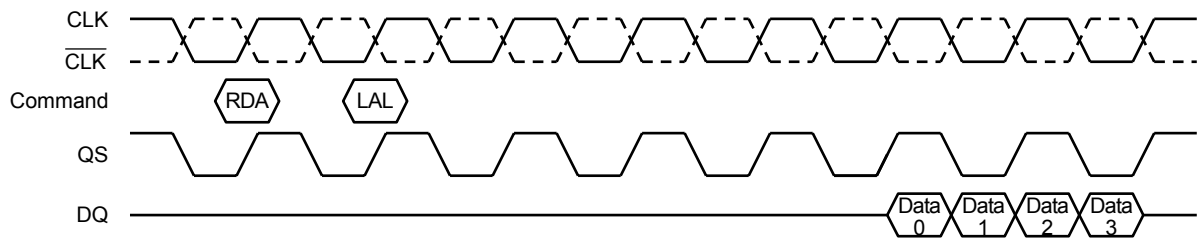

Addressing sequence for Sequential mode

DATA	ACCESS ADDRESS	BURST LENGTH
Data 0	n	} 2 words (address bits is LA0) not carried from LA0~LA1
Data 1	n + 1	
Data 2	n + 2	} 4 words (address bits is LA1, LA0) not carried from LA1~LA2
Data 3	n + 3	

• Addressing sequence of Interleave mode

A column access is started from the inputted lower address and is performed by interleaving the address bits in the sequence shown as the following.

Addressing sequence for Interleave mode

DATA	ACCESS ADDRESS	BURST LENGTH
Data 0	...A8 A7 A6 A5 A4 A3 A2 A1 A0	} 2 words
Data 1	...A8 A7 A6 A5 A4 A3 A2 A1 $\overline{\text{A0}}$	
Data 2	...A8 A7 A6 A5 A4 A3 A2 $\overline{\text{A1}}$ A0	} 4 words
Data 3	...A8 A7 A6 A5 A4 A3 A2 $\overline{\text{A1}}$ $\overline{\text{A0}}$	

(R-3) $\overline{\text{CAS}}$ Latency field (A6 to A4)

This field specifies the number of clock cycles from the assertion of the LAL command following the RDA command to the first data read. The minimum value of $\overline{\text{CAS}}$ Latency depends on the frequency of CLK. In a write mode, the place of clock that should input write data is $\overline{\text{CAS}}$ Latency cycles - 1.

A6	A5	A4	$\overline{\text{CAS}}$ LATENCY
0	0	0	Reserved
0	0	1	Reserved
0	1	0	Reserved
0	1	1	Reserved
1	0	0	4
1	0	1	5
1	1	0	6
1	1	1	Reserved

(R-4) Test Mode field (A7)

This bit is used to enter Test Mode for supplier only and must be set to "0" for normal operation.

(R-5) Reserved field in the Regular Mode Register

- Reserved bits (A8 to A14)

These bits are reserved for future operations. They must be set to "0" for normal operation.

Extended Mode Register fields

(E-1) DLL Switch field (A0)

This bit is used to enable DLL. When the A0 bit is set “0”, DLL is enabled. This bit must be set to “0” for normal operation.

(E-2) Output Driver Impedance Control field (A1 to A4)

This field is used to choose Output Driver Strength. Three types of Driver Strength are supported. QS and DQ Driver Strength can be chosen separately. A2-A1 specified the DQ Driver Strength. A4-A3 specified the QS Driver Strength.

QS		DQ		OUTPUT DRIVER IMPEDANCE CONTROL
A4	A3	A2	A1	
0	0	0	0	Normal Output Driver
0	1	0	1	Strong Output Driver
1	0	1	0	Weak Output Driver
1	1	1	1	Reserved

(E-3) Strobe Select (A6 / A5)

Two types of data strobe are supported. This field is used to choose the type of data strobe.

(1) Unidirectional DS/QS mode

Data strobe is separated DS for write strobe and QS for read strobe.

DS is used to sample write data at write operation. QS is aligned with read data at Read operation.

(2) Unidirectional DS/Free running QS mode

Data strobe is separated DS for write strobe and QS for read strobe.

DS is used to sample write data at write operation. QS is aligned with read data and always clocking.

A6	A5	STROBE SELECT
0	0	Reserved
0	1	Reserved
1	0	Unidirectional DS/QS mode
1	1	Unidirectional DS/Free running QS mode

(E-4) Reserved field (A7 to A14)

These bits are reserved for future operations and must be set to “0” for normal operation.

PACKAGE DIMENSIONS

P-BGA60-0917-1.00AZ

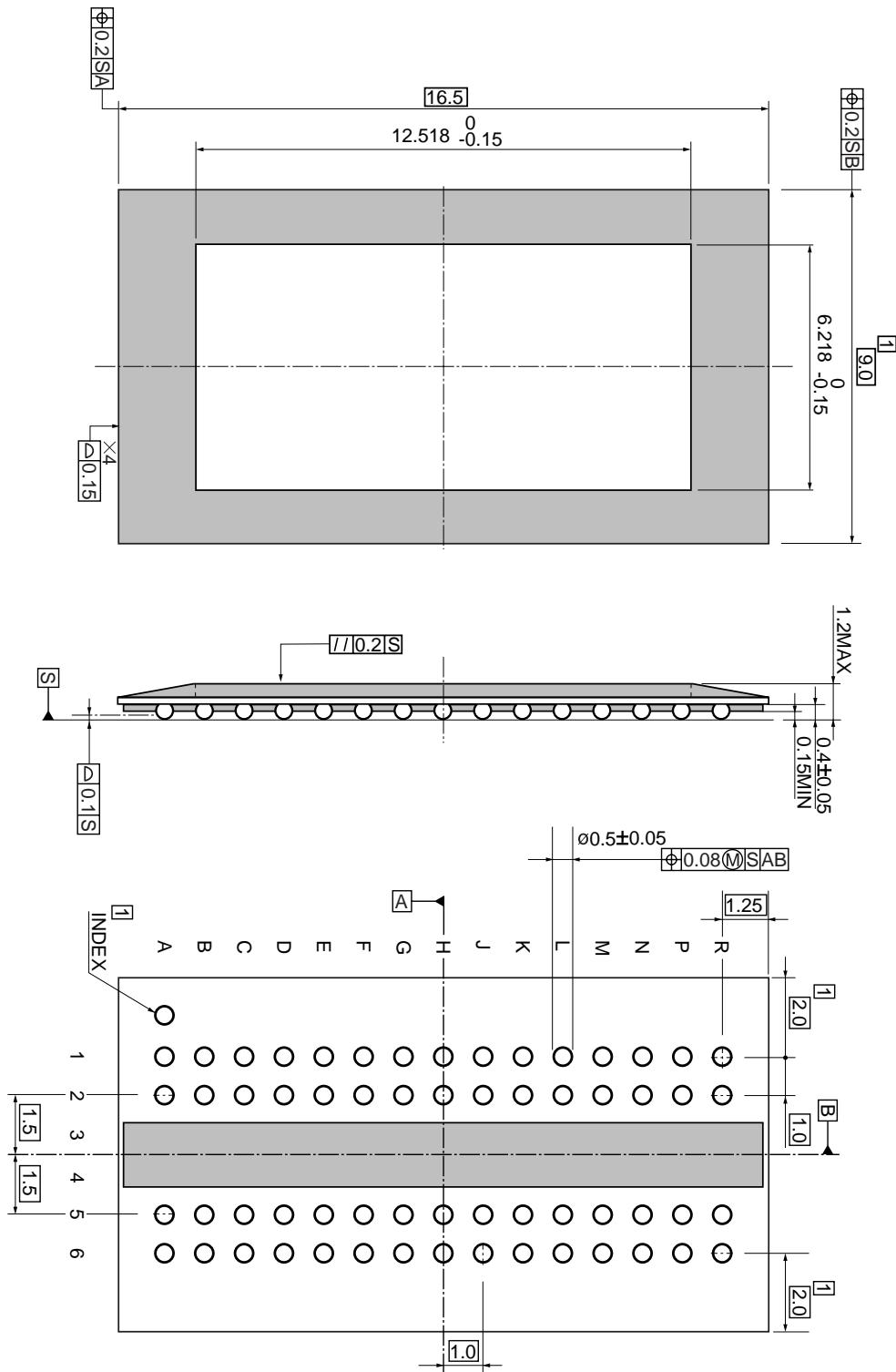

Weight: 0.15 g (typ.)

REVISION HISTORY

- Rev.1.1 (Jan. 17 '2005)
Difference between lead product(P/N: TC59LM818DMB) and this lead-free product in this datasheet is only part number and notes for lead-free product on page 1.
- Rev.1.2 (Mar. 7 '2005)
Corrected figure of I_{PDA} based AC timing spec table (page 11, 40, 41, 47, 48).
- Rev.1.3 (Sep. 26 '2005)
IDD6(Self-Refresh current) spec changed from 10mA to 15mA (page 1 and 6).
- Rev.1.4 (Oct.19 '2005)
"-30"(333MHz clock/666Mbps) version dropped.

RESTRICTIONS ON PRODUCT USE

030619EBA

- The information contained herein is subject to change without notice.
- The information contained herein is presented only as a guide for the applications of our products. No responsibility is assumed by TOSHIBA for any infringements of patents or other rights of the third parties which may result from its use. No license is granted by implication or otherwise under any patent or patent rights of TOSHIBA or others.
- TOSHIBA is continually working to improve the quality and reliability of its products. Nevertheless, semiconductor devices in general can malfunction or fail due to their inherent electrical sensitivity and vulnerability to physical stress. It is the responsibility of the buyer, when utilizing TOSHIBA products, to comply with the standards of safety in making a safe design for the entire system, and to avoid situations in which a malfunction or failure of such TOSHIBA products could cause loss of human life, bodily injury or damage to property.
In developing your designs, please ensure that TOSHIBA products are used within specified operating ranges as set forth in the most recent TOSHIBA products specifications. Also, please keep in mind the precautions and conditions set forth in the "Handling Guide for Semiconductor Devices," or "TOSHIBA Semiconductor Reliability Handbook" etc..
- The TOSHIBA products listed in this document are intended for usage in general electronics applications (computer, personal equipment, office equipment, measuring equipment, industrial robotics, domestic appliances, etc.). These TOSHIBA products are neither intended nor warranted for usage in equipment that requires extraordinarily high quality and/or reliability or a malfunction or failure of which may cause loss of human life or bodily injury ("Unintended Usage"). Unintended Usage include atomic energy control instruments, airplane or spaceship instruments, transportation instruments, traffic signal instruments, combustion control instruments, medical instruments, all types of safety devices, etc.. Unintended Usage of TOSHIBA products listed in this document shall be made at the customer's own risk.
- The products described in this document are subject to the foreign exchange and foreign trade laws.
- TOSHIBA products should not be embedded to the downstream products which are prohibited to be produced and sold, under any law and regulations.

Rev 1.4

2005-10-19 57/57